

GURLEY'S MANUAL.



AMERICAN
ENGINEERS' AND SURVEYORS'
INSTRUMENTS.



THIRTY-FIFTH EDITION, REVISED.

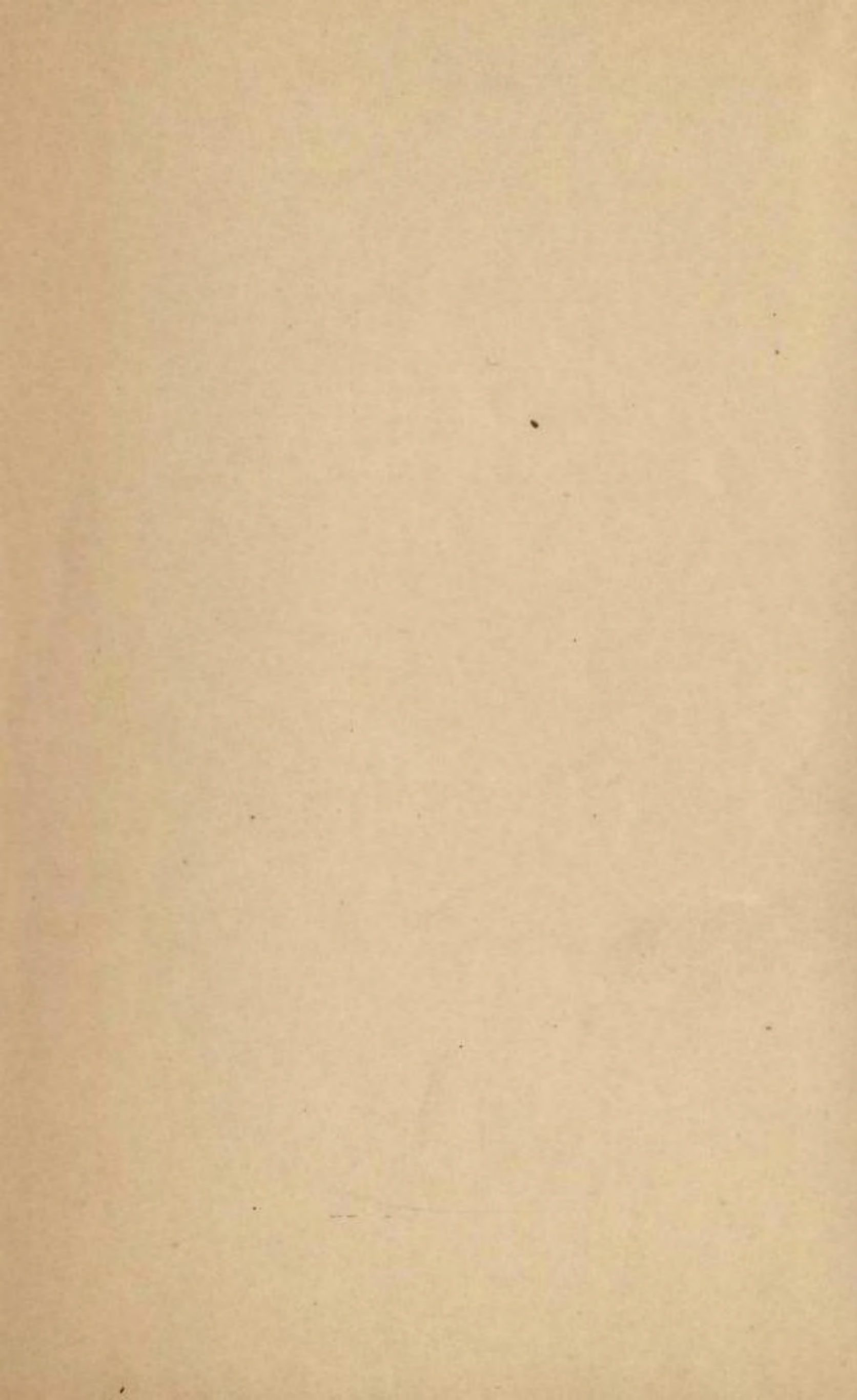

A MANUAL
OF THE PRINCIPAL
INSTRUMENTS

USED IN

American Engineering and Surveying,

MANUFACTURED BY

W. & L. E. GURLEY,

TROY, N. Y., U. S. A.

THIRTY-FIFTH EDITION.

*

TROY, N. Y.
PUBLISHED BY W. & L. E. GURLEY
1901.

PRICE, 50 CENTS.

Entered, according to Act of Congress, in the Year 1901,
By W. & L. E. GURLEY,
In the Office of the Librarian of Congress, at Washington.

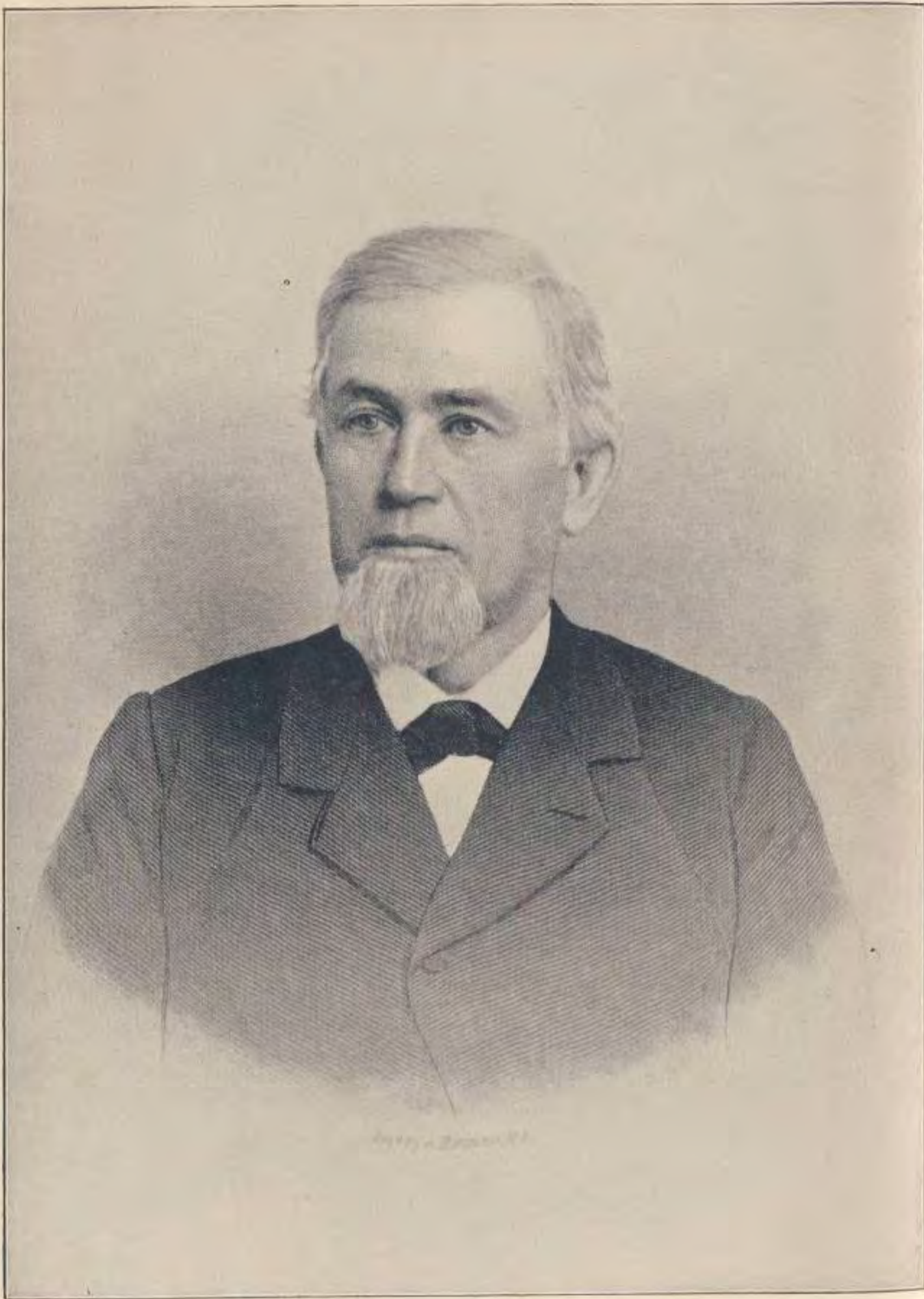

William Gurley



Lewis E. Gurley

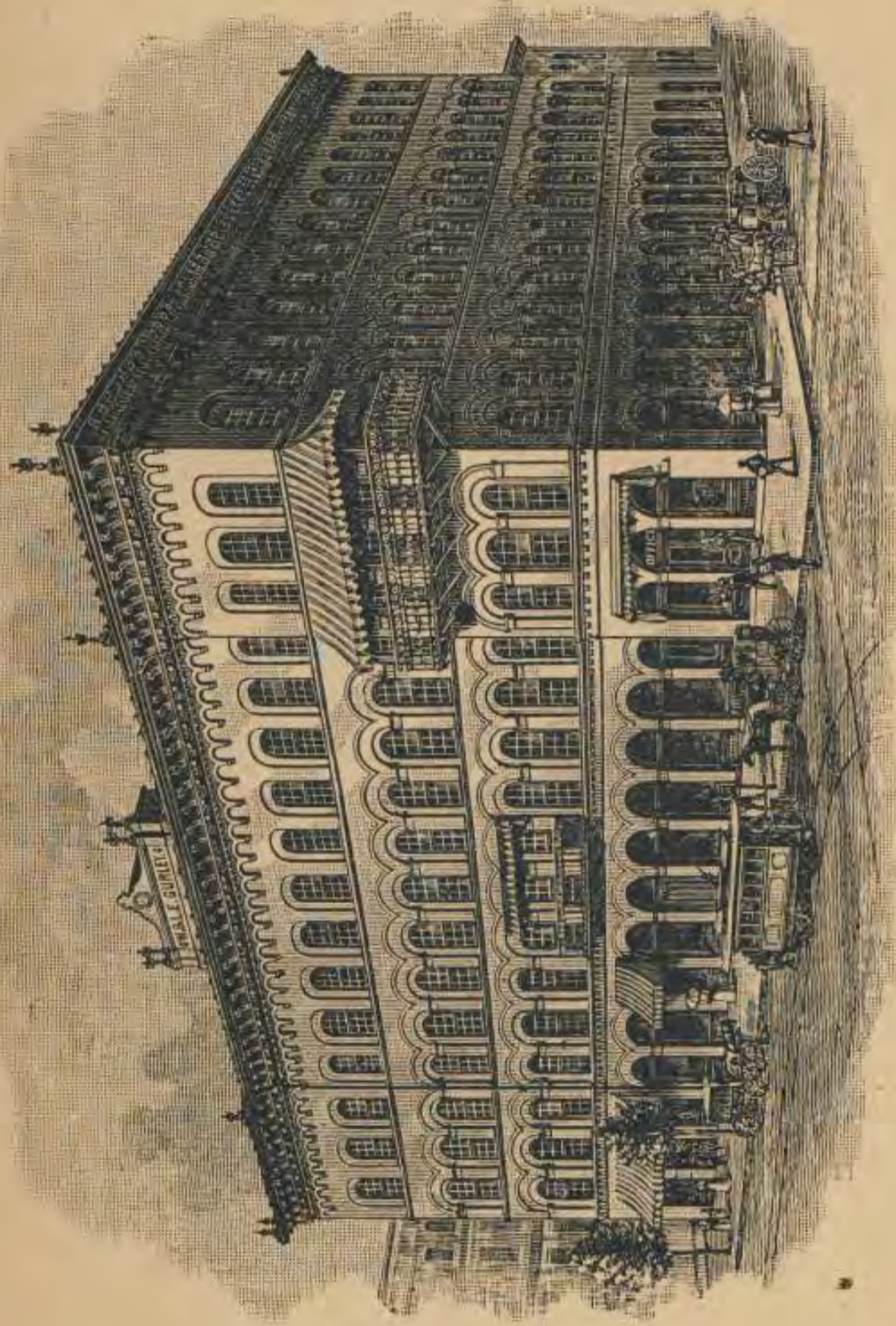

W. & L. E. GURLEY'S INSTRUMENT MANUFACTORY.—ESTABLISHED 1845.

1845-1901.

PREFACE TO THE THIRTY-FIFTH EDITION.

AUGUST, 1901.

MORE THAN FIFTY YEARS AGO the manufacture of Civil Engineers' and Surveyors' instruments was begun in this city by Jonas H. Phelps and William Gurley. Mr. Phelps retiring some years later, Lewis E. Gurley formed with William Gurley the firm of W. & L. E. Gurley; and under this name the business has since been conducted.

The first edition of GURLEY'S MANUAL was published in 1855, a book of seventy pages. It was well received, and was the first really practical treatise on the use and adjustment of Civil Engineers' and Surveyors' instruments.

The revised and enlarged MANUAL is used as a textbook in many schools and colleges, and is freely quoted in technical publications.

The capacity of the factory has been increased as the demands of the profession have grown during the half century, until we are now the most extensive manufacturers of Civil Engineers' and Surveyors' instruments in the world.

We expect to have our instruments judged upon their merits, and any Surveyor or Civil Engineer who will carefully examine our work will be pleased with it.

W. & L. E. GURLEY,

TROY, N. Y., U. S. A.

TRANSIT-INSTRUMENTS.

THE AMERICAN TRANSIT, in its various modifications, is by far the most important of all the instruments used in engineering. The essential parts, as shown in the cuts, are the Telescope with its axis and two standards, the Circular Plates with their attachments, the Sockets upon which the plates revolve, the Leveling-Head, and the Tripod upon which the whole instrument stands.

The Telescope is from ten to eleven inches long, firmly secured to an axis having its bearings nicely fitted in the standards, enabling the telescope to be moved up and down if desired. The different parts of the telescope are shown on page 7.

TELESCOPE.

The object-glass is a compound lens, achromatic, and showing objects without distortion, and is placed at the end of a slide having two bearings, one at the end of the outer tube, the other in the ring, C C, suspended within the tube by four screws, only two of which are shown in the cut.

OBJECT-GLASS.

Both the object-glass and eyepiece are moved out or in by pinions working in racks attached to their slides, and are thus adjusted to proper focus.

The eyepiece is made up of four lenses, which, beginning at the eye end, are called respectively the eye, the field, the amplifying and the object lens, the whole forming a compound microscope having its focus in the plane of the cross-wire ring, B B.

EYEPIECE.

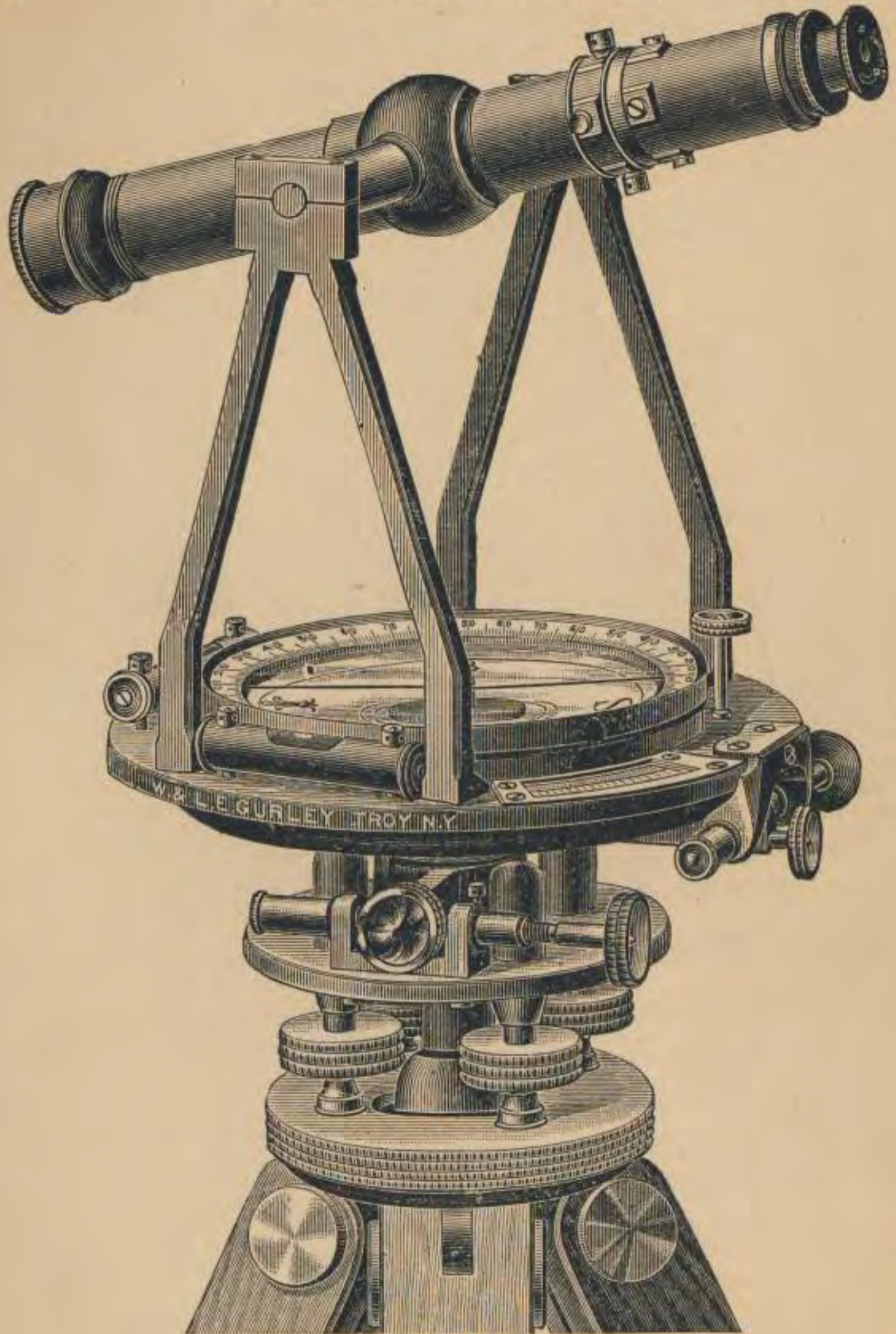
**No. 12.**

Engineers' Transit, with 5-inch needle, plain telescope and tripod
Price as shown, \$150.00.

Sometimes an eyepiece with two lenses is employed ; but this, while it gives more light, inverts the image of the object seen, and is seldom used by American engineers.

The object-glass, receiving the rays of light which proceed from all the points

of a visible object, converges them to a focus at the cross-wires, and there forms a minute, inverted and very bright image, which may be seen by placing a piece of ground glass to receive it at that point.

The eyepiece, acting as a compound microscope, magnifies this image, restores it to its natural position, and conveys it to the eye.

The visual angle which the image there subtends is as many times greater

than that which would be formed without the use of the telescope, as the number which expresses its magnifying power is greater than unity. Thus, a telescope which magnifies twenty times increases the visual angle just as much, and therefore diminishes the apparent distance of the object twenty times ; or, in other words, it will show an object two hundred feet distant with the same distinctness as if it were only ten feet distant from the naked eye.

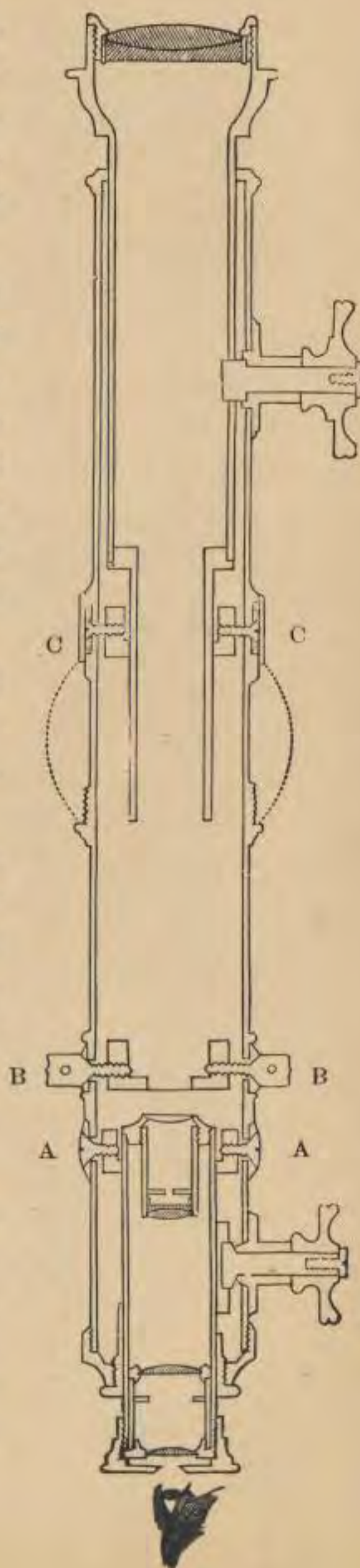

It might be supposed that the greater the power of a telescope the better; but, beyond a certain limit, this is found to be incorrect. As only a given amount of light can enter the object-glass, the more the object is magnified the less clear and bright will it appear; and the higher the power the more difficult will it be to focus the telescope precisely and to complete its adjustment. We have found that a power of from twenty to twenty-four diameters in the telescopes of Transits gives the best results, and is sufficient for all ordinary practice.

The cross-wires are two wires of very fine platinum, cemented into the cuts on the surface of a metal ring. They are placed at right angles with each other, so as to divide the open space in the center into quadrants.

To remove the cross-wire ring, take out the eyepiece together with the little ring by which it is centered, and having removed two opposite cross-wire screws, with the others turn the ring until one of the screw holes is brought into view from the open end of the telescope tube; in this screw hole thrust a pointed splinter of wood or a small wire, to hold the ring when the remaining screws are withdrawn; the ring can then be taken out. It may be replaced by returning it to its position in the tube, and when either pair of screws is inserted, the splinter or wire is removed, and the ring is turned until the other screws can be replaced.

Care must be taken that the face of the diaphragm is turned toward the eyepiece. When this has been done, the eyepiece is inserted, and its centering-ring brought

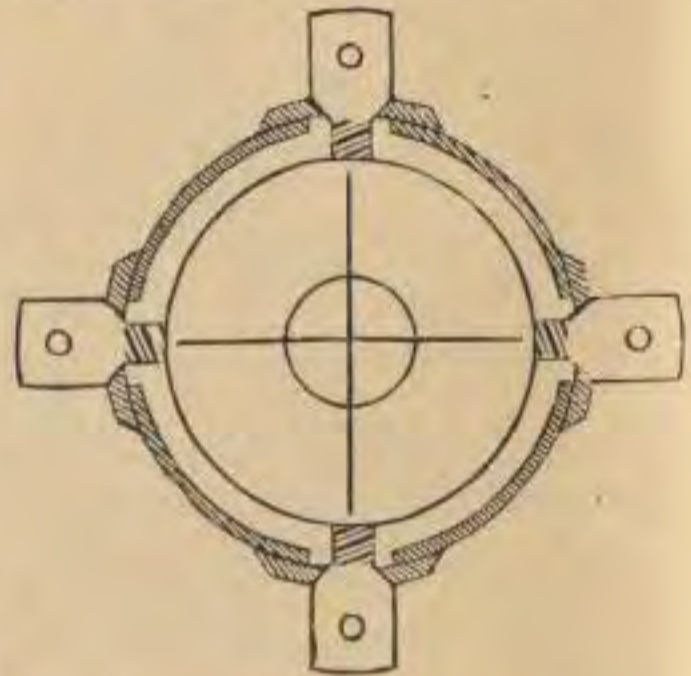

into such a position that the screws in it can be replaced, and then, after screwing to the end of the telescope the little ring into which the eyepiece is fixed, the operation will be complete.

The advantage of platinum over spider-web for the cross-wires of telescopes has long been conceded, but the difficulty of procuring it of sufficient fineness has prevented its general use. We are now successfully drawing platinum wires of from one eight-thousandth to one twelve-thousandth of an inch in diameter, and are using them in the telescopes of all our instruments. These wires are perfectly opaque, and, of course, entirely unaffected by moisture; and are universally preferred to the spider-web heretofore used.

The intersection of the wires forms a very minute point which, when adjusted, determines the optical axis of the telescope and enables the Surveyor to fix it upon an object with the greatest precision. The imaginary line passing through the optical axis of the telescope is called the "line of collimation," and the operation of bringing the intersection of the wires into the optical axis is called the "adjustment of the line of collimation." This is described on pages 19-22.

The openings in the telescope tube are made considerably larger than the screws used in adjusting the cross-wires, so that, when the screws are loosened, the ring can be turned for a short distance in either direction. The object of this will be seen more plainly when we describe the means by which the wire is made truly vertical.

The sectional view of the telescope also shows two movable rings, one placed at A A, the other at C C, which are used respectively in centering the eyepiece and in the adjustment of the object-glass slide.

The centering of the eyepiece is performed after the wires have been adjusted, and is effected by moving the ring, by means of the screws shown on the outside of the tube, until the intersection of the wires is brought into the center of the field of view.

The adjustment of the object-glass slide, which is described on pages 23 and 24, keeps the line of collimation in adjustment through the whole range of the slide, preventing, at the same time, what is called the "traveling" of the wires. This adjustment, which is peculiar to our telescopes, is always made in the process of construction, and needs no further attention from the Engineer.

The Stadia, or Micrometer, is a compound cross-wire ring or diaphragm,

STADIA. as shown, having three horizontal wires, of which the middle one is cemented to the ring as usual, while the others are fastened to small slides, held apart by a slender brass spring hoop and actuated by independent screws, by which the distance between the two movable wires can be adjusted to include a given space, as one foot on a rod one hundred feet distant.

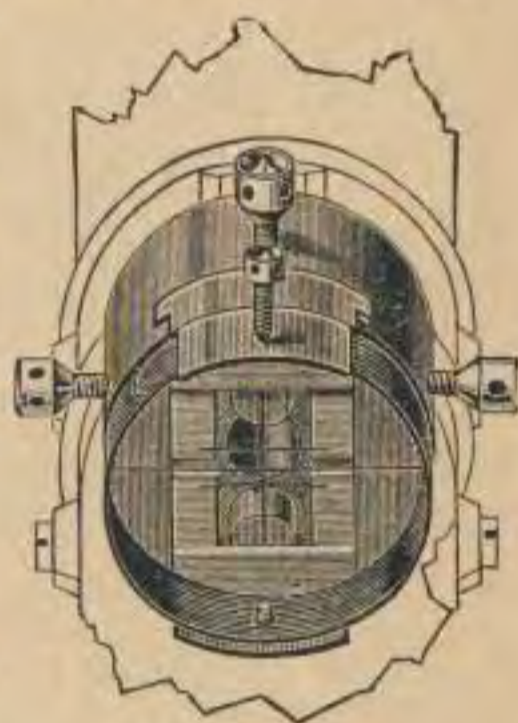

These wires will in the same manner include two feet on a rod two hundred feet distant, or half a foot at a distance of fifty feet, and so on in the same proportion, thus furnishing a means of measuring distances, especially over broken ground, more easily and even more accurately than with a tape or chain. We put stadia wires in all Transit telescopes without extra cost, if requested when the instrument is ordered.

While more convenient to make stadia measurements from the center of the instrument, the increasing use of the stadia demanding measurements made with the utmost accuracy and for shorter distances compels the use of the "constant;" that is, the wires are adjusted to read one foot on the rod at a distance from the center of the instrument of, say, 100 feet plus c plus f ; c being the distance of the object-glass from the center of the instrument, found by measuring from the center of the axis to the shoulder of the setting of the object-glass when it is focused on a mean distance of about 200 feet; and f being the focal length of the object-glass, found by measuring from the cross-wires to the object-glass.

The "constant" for each instrument, or distance of the zero of the indicated distance in front of the center of the instrument, is noted on a card placed on the inside of the instrument box.

For example, in our eleven-inch telescopes, such as are used with our larger transits, $c = 5\frac{3}{10}$ inches and $f = 8$ inches; $c + f = 13\frac{3}{10}$ inches. In our Mountain Transit telescopes, $c = 3\frac{9}{10}$ inches and $f = 5\frac{4}{10}$ inches; $c + f = 9\frac{3}{10}$ inches. In our Reconnaissance Transit telescopes, $c = 4\frac{1}{4}$ inches and $f = 5\frac{3}{4}$ inches; $c + f = 10$ inches.

The stadia wires are ordinarily arranged so that they are seen at the same time as the cross-wires. We now **DISAPPEARING STADIA.** arrange them, when desired, so that they are out of focus when the main wires are visible, or vice versa. Many Engineers prefer this method, as being less confusing to the observer and lessening the liability for errors in observation.

FIXED STADIA. The stadia wires are *fixed*, when desired, on the same ring with the cross-wires. In such case the customer should clearly specify whether he wishes to

measure distances from the center of the instrument, or to use a "constant."

The Dust-Guard to the object-glass slide, as seen in the cut, is placed on the telescope of Transits Nos. 1 to 117,

DUST-GUARD. when desired. This guard effectively shields the object-glass slide, and prevents any dust or foreign substance from interfering with the perfect action of the slide. We now place the dust-guard on new Transits without extra charge, when so ordered; the cost of placing it on an old Transit of our manufacture is \$4.00.

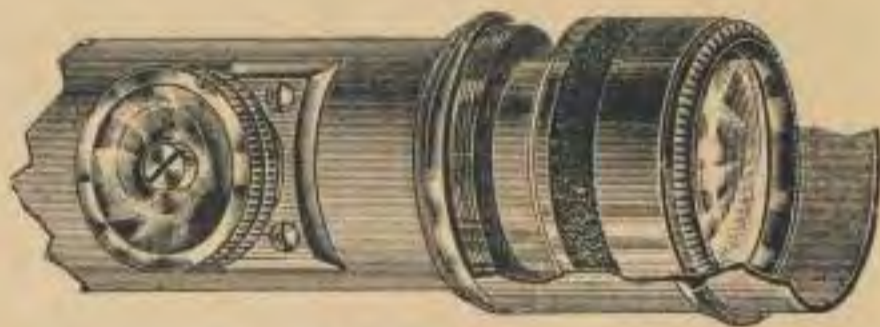

No. 154.

The Standards of the Transit are firmly attached by their expanded bases to the upper plate, one of them having **STANDARDS.** near the top, as shown on page 38, a little box, actuated by a screw underneath, by which the telescope axis is made truly horizontal, as described on page 23.

The Magnetic Needle is from three and one-half to six inches long in the different sizes of Transits, its brass cap **MAGNETIC NEEDLE.** having inserted in it a jeweled-center of special shape and perfectly polished, and this, resting upon the hardened and polished point of the center-pin, allows the needle to play freely in a horizontal direction and settle in the magnetic meridian.

The needle has its north end designated by a scollop or other mark, and on its south end is a small coil of fine brass wire, easily moved so as to bring both ends of the needle to the same level. The needle is lifted from the pin by a lever concealed underneath the upper plate, actuated by a

screw shown above, thus raising the button so as to check the vibration of the needle, or bring it up against the glass when not in use, and avoid the unnecessary wear of the pivot.

The form of the needle is varied according to the taste or fancy of the maker or Surveyor, but may be resolved into two general classes, one having the greatest breadth in a horizontal, the other in a vertical direction.

We usually make our needles about eight one-hundredths of an inch broad, and about three one-hundredths of an inch thick, with the ends brought to a sharp vertical edge ; but whenever desired we supply other forms.

The test of the delicacy of a magnetic needle is the number of horizontal vibrations which it will make in a certain arc before coming to rest ; besides this, most Surveyors prefer to see also a quivering motion in a vertical direction.

This quality, which is manifested more in a horizontal than in a vertical needle, depends upon the near coincidence of the point of suspension with the center of gravity of the needle, and merely serves to show that the cap below is unobstructed.

The compass-box containing the needle is covered by a glass to exclude the moisture and air ; the circle is silvered and divided on its upper surface into degrees and half degrees, and figured from 0 to 90 on each side of the middle or line of zeros ; the degree marks are also cut down on the inner edge.

A variation arc, for setting off the variation of the needle, is furnished with any new Engineers' Transit, Nos. 1 to 16, if ordered with the instrument, at an extra cost of \$4.00.

The Clamp and Tangent movement, as now improved, has its tangent screw with opposing spring attached to the upper plate, as shown on

**VARIATION
ARC.**

**CLAMP AND
TANGENT.**

page 6 ; the clamp is shown in section on page 14, being a strong metal ring, D F, moving easily around the solid outer socket, to which it is securely fixed at will by a clamp-screw, E, impinging upon a small segment, F. By this means the plates are clamped to each other, and moved slowly around each other in either direction by the tangent screw, or loosened at will and moved by the hand, the telescope being thus easily and accurately directed to the point of sight.

The two levels are placed at right angles with each other so as to level the plate in all directions, and are adjusted by turning the capstan-head
PLATE-LEVELS. nuts at their ends by a small steel adjusting-pin. The glass vials used in the levels of all our Transits are ground on their interior surface, so as to give the bubble an even motion and great sensitiveness.

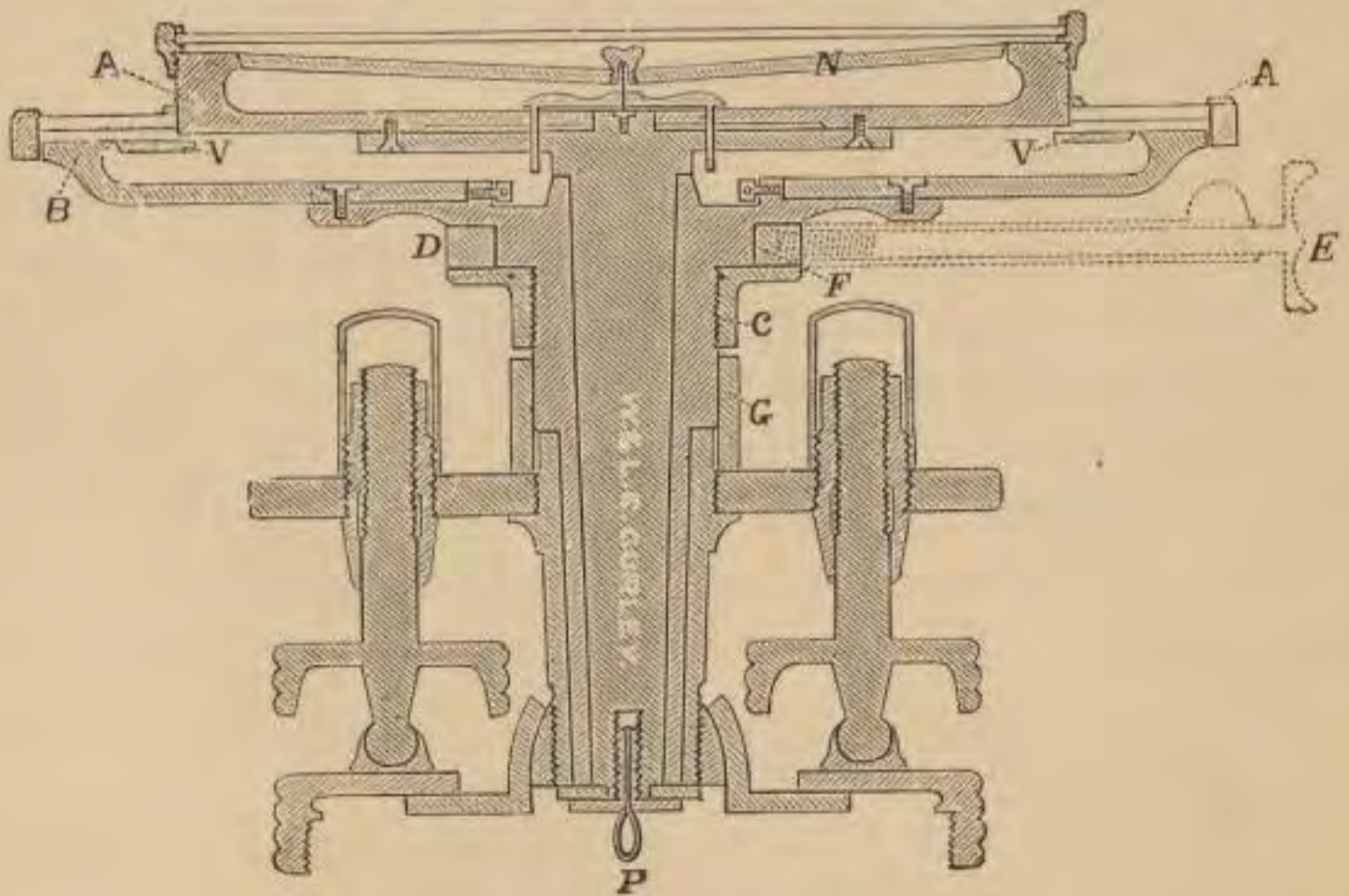

THE SOCKETS AND CIRCULAR PLATES.

The Lower Plate, or Limb (at B in preceding cut) is divided on its upper surface, usually into **HORIZONTAL LIMB.** degrees and half degrees, and figured in two rows, from 0 to 360 and from 0 to 90 each way; sometimes but a single series is used, and then the figures run from 0 to 360 or from 0 each way to 180. The figuring may be varied according to the wish of the person ordering the instrument, the double series being always used unless otherwise specified.

The Verniers, V V, are attached to the upper plate diametrically opposite to each other, and are **VERNIERS.** used in reading the limb around which they revolve.

The verniers are double, having on each side of the zero mark thirty equal divisions corresponding precisely with twenty-nine half degrees of the limb; they thus read to single minutes, and the number passed over is counted in the same direction in which the vernier is moved.

The place of the verniers is in front of the observer and at an angle of thirty degrees with the telescope, so that they are easily read without a change of position. We have adopted this improvement in all our instruments.

The use of two opposite verniers gives the means of cross-questioning the graduations, the perfection with which they are centered and the dependence which can be placed upon the accuracy of the angles indicated.

Sometimes a smaller reading than minutes is desired, and then the spaces of the limb and vernier are both made proportionately less, so as to give readings to thirty, twenty, or even ten seconds of arc, if required. The vernier openings are covered with glass, carefully cemented to exclude moisture and dust.

Reflectors of celluloid, as in the Mountain Transit, are often used to throw more light upon the divisions, and shades of ground glass are sometimes used to give a more subdued light.

REFLECTORS.

The Graduations were formerly made on the brass surface of the limb, afterwards filled with black wax, and then finished and silvered. The limbs of all our Transits are now covered with sterling silver; the graduations are much finer and more distinct, and the surfaces less liable to tarnish or change color.

GRADUATIONS.

This improvement, which costs quite a large sum, we make without additional charge.

To make possible the utmost accuracy of graduation, the limbs of our Transits are polished and the figures engraved before cutting the divisions, thus avoiding any possible chance for molecular change after the graduation is made.

The Sockets of the Transit are compound; the interior spindle attached to the vernier plate turning in the exterior socket, C, when an angle is taken on the limb, but when the plates are clamped together the exterior socket itself, and with it the whole instrument, revolves in the socket of the leveling-head.

SOCKETS.

The sockets are made with the greatest care, the surfaces being truly concentric with each other, and the composition of which they are made being of different degrees of hardness, so as to cause them to move upon each other easily and with the least possible wear.

The Leveling-head consists of two plates connected by a socket, having at its end a hemispherical nut fitting into a corresponding cavity in the lower plate. The plates are inclined to each other or made parallel at will by four leveling-screws.

LEVELING-HEAD.

The screws are of bronze, and are fitted to long nuts in the upper parallel plate. They are protected from dust by brass covers screwed on the upper ends of the nuts.

The screws rest in little cups or sockets, which are secured to their ends, and in which they turn without marring the surface of the lower plate, the cups also permitting the screws to be shifted from side to side, or turned in either direction on the lower plate.

The clamp and tangent movement of the leveling-head, partially shown on page 6, serves to turn the whole instrument upon its sockets so as to fix the telescope with precision upon any given point, and when unclamped allows it to be directed approximately by hand. The tangent screw is single, as shown, and has an opposing spring by which lost motion is avoided and a very fine and prompt movement secured.

The lower leveling-plate is made in two pieces, the upper one, which is screwed fast to the top of the tripod, **SHIFTING CENTER.** having a large opening in the center, in which the smaller lower plate is shifted from side to side or turned completely around. By this simple arrangement, called a "shifting center," the instrument is easily moved over the upper plate, and the plummet which hangs from the center, P, (see page 14), may be set precisely over a point without moving the tripod.

The Tripod has a head of bronze with three strong tenons to receive the legs, the upper ends of which are pressed firmly on each side of the tenon by a **TRIPOD.** bolt and nut on opposite sides of the leg; the nut can be screwed up at will, and thus kept firm.

The lower end of the leg has a brass shoe with steel point, securely fastened and riveted to the wood.

For various patterns of tripods see pages 172-175.

TO USE THE TRANSIT.

The instrument should be set up firmly, the tripod legs being pressed into the ground, so as to bring the plates as nearly level as convenient ; the plates should then be carefully leveled and properly clamped.

For precise work, in addition to leveling by the plate levels, it is always advisable, if the Transit has such attachment, to level the plates by the telescope level, as this is much more sensitive than the levels on the plate.

It must be carefully noted that in this operation the position of the level on telescope must be observed over both sets of leveling-screws, and one-half the correction made by the axis tangent, the other half by the leveling-screws.

The zeros of the verniers and limb should be brought into line by the tangent screw of the plates and the telescope directed to the object by the tangent screw of the leveling-head.

The angles taken are then read off upon the limb, without subtracting from those given by the verniers in any other position.

Before an observation is made with the telescope, the eyepiece should be focused by its pinion until the cross-wires appear distinct to the eye of the observer ; the object-glass is then focused by its pinion until the object is seen clear and well-defined, and the wires appear as if fastened to its surface.

The intersection of the wires (the means by which the optical axis of the telescope is defined) should be brought precisely upon the middle of the object to which the instrument is directed.

TO ADJUST THE TRANSIT.

Every instrument should leave the hands of the maker in complete adjustment, but all are so liable to derangement by accident or careless use that we deem it necessary to describe particularly those adjustments which are most likely to need attention.

The principal adjustments of the Transit are: **THE LEVELS.**—**THE LINE OF COLLIMATION.**—**THE STANDARDS.**

To adjust the Levels: Set up the instrument upon its tripod as nearly level as may be, and having unclamped the plates, bring the two levels above, and
THE LEVELS. on a line with, the two pairs of leveling-screws; then with the thumb and first finger of each hand clasp the heads of two opposite screws, and, turning both thumbs in or out, as may be needed, bring the bubble of the level directly over the screws, exactly to the middle of the opening. Without moving the instrument, proceed in the same manner to bring the other bubble to the middle; after doing this the level first corrected may be thrown a little out; bring it in again; and when both are in place turn the instrument half-way around; if the bubbles are both in the middle, they need no correction; but if not, with the adjusting-pin turn the small nuts at the end of the levels until the bubbles are moved over half the error; then bring the bubbles again into the middle by the leveling-screws; and repeat the operation until the bubbles will remain in the middle during a complete revolution of the instrument, when the adjustment will be complete.

To adjust the Line of Collimation: To make this ad-
LINE OF justment, which is to bring the intersec-
COLLIMATION. tion of the wires into the optical axis of the telescope, so that the instrument, when placed in the middle

of a straight line, will, by the revolution of the telescope, cut its extremities, proceed as follows :

Set the instrument firmly on the ground and level it carefully ; then, having brought the wires into the focus of the eyepiece, adjust the object-glass upon some well-defined point at a distance of from two hundred to five hundred feet ; determine if the vertical wire is plumb, by clamping the instrument and applying the wire to the vertical edge of a building, or observing if it will move parallel to a line taken a little to one side ; should any deviation be manifested, loosen the cross-wire screws, and by the pressure of the hand on the heads outside the tube, move the ring around until the error is corrected.

The wires being thus made respectively horizontal and vertical, fix their point of intersection on the object selected ; clamp the instrument to the spindle, and having revolved the telescope, find or place some good object in the opposite direction, and at about the same distance from the instrument as the first object selected.

Great care should always be taken in turning the telescope, that the position of the instrument upon the spindle is not in the slightest degree disturbed.

Now, having found or placed an object which the vertical wire bisects, unclamp the upper plate, turn it half-way around, and direct the telescope to the object first selected ; having bisected this with the wires, again clamp the instrument, revolve the telescope, and note if the vertical wire bisects the second object observed.

Should this be the case, it will indicate that the wires are in adjustment, and the points bisected are in the same straight line with the center of the instrument.

If not, however, the space which separates the wires from the second point observed will be double the devia-

tion of that point from a true straight line, which may be conceived as drawn through the first point and the center of the instrument, since the error is the result of two observations made with the wires when they are out of the optical axis of the telescope.

In the cut below, let A represent the center of the instrument, and B C the imaginary straight line, upon the extremities of which the line of collimation is to be adjusted.

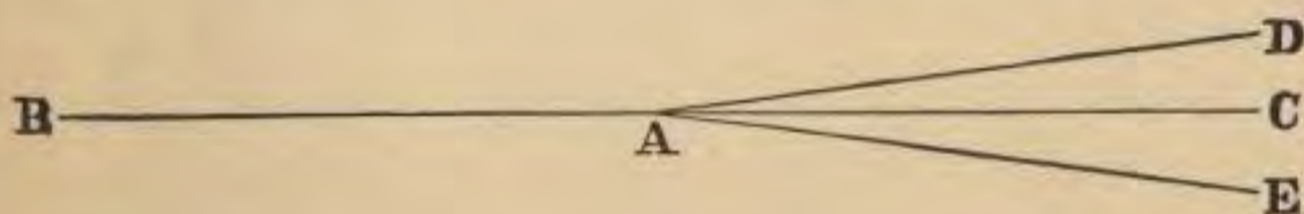

B represents the object first selected, and D the point which the wires bisected when the telescope was reversed.

In our description of this operation, we have spoken more particularly of the vertical wire, because in a revolving telescope this occupies the most important place, the horizontal wire being used mainly to define the middle of the vertical wire, so that it may be moved either up or down without materially disturbing the line of collimation.

When the instrument is turned half around, and the telescope again directed to B, and once more reversed, the wires will bisect an object, E, situated as far to one side of the true line as the point, D, is on the other side. The space, D E, is therefore the sum of two deviations of the wires from a true straight line, and the error is made very apparent.

In order to correct it use the two capstan-head screws on the sides of the telescope, these being the ones which affect the position of the vertical wire.

Remember that the eyepiece inverts the position of the wires, and therefore that in loosening one of the screws

and tightening the other on the opposite side, the operator must proceed as if to increase the error observed.

Having in this manner moved back the vertical wire until, by estimation, one quarter of the space, D E, has been passed over, return the instrument to the point, B, reverse the telescope, and if the correction has been carefully made the wires will now bisect a point, C, situated midway between D and E, and in the prolongation of the imaginary line passing through the point, B, and the center of the instrument.

To ascertain if such is the case, turn the instrument half around, fix the telescope upon B, clamp to the spindle, and again revolve the telescope toward C. If the wires again bisect it, it will prove that they are in adjustment, and that the points, B, A and C, all lie in the same straight line. Should the vertical wire strike to one side of C, the error must be corrected precisely as above described, until it is entirely removed.

The wires being adjusted, their intersection may now be brought into the center of the field of view by moving the screws, A A, shown in the sectional view of the telescope, page 7, which are slackened and tightened in pairs, the movement being now direct, until the wires are seen in their proper position.

It is here proper to observe that the position of the line of collimation depends upon that of the objective solely, so that the eyepiece may, as in the case just described, be moved in any direction, or even entirely removed and a new one substituted, without at all deranging the adjustment of the wires.

To adjust the Standards : In order that the point of intersection of the wires may trace a vertical line as the telescope is moved up or down, it is necessary that both the standards of the tele-

STANDARDS.

scope should be of precisely the same height. To ascertain this, and make the correction if needed, proceed as follows :

Having the line of collimation previously adjusted, set up the instrument in a position where points of observation, such as the point and base of a lofty spire, can be selected, giving a long range in a vertical direction.

Level the instrument, fix the wires on the top of the object, and clamp to the spindle ; then bring the telescope down until the wires bisect some good point, either found or marked at the base ; turn the instrument half around, fix the wires on the lower point, clamp to the spindle, and raise the telescope to the highest point. If the wires bisect it, the vertical adjustment is effected ; if they are thrown to either side this proves that the standard opposite to that side is the highest, the apparent error being double that actually due to this cause. To correct it, we make one of the bearings of the axis movable, so that by turning a screw underneath this sliding piece, as well as the screws which fasten the cap of the standard, the adjustment is made with the utmost precision. This arrangement, which is common to all of our Transits, is very substantial and easily managed.

Beside the three adjustments already described, which are all that the Surveyor will ordinarily be required to make, there are *other adjustments* of the Transits which may sometimes be required.

To adjust the Object-glass Slide : Having set up and leveled the instrument, the line of collimation being also adjusted for objects from three hundred

OBJECT-GLASS SLIDE. to five hundred feet distant, clamp the plates, and fix the vertical cross-wire upon an object as distant as may be distinctly seen ; then, without disturbing

the instrument, move out the object-glass so as to bring the vertical wire upon an object as near as the range of the telescope will allow. Having this clearly in mind, loosen the upper clamp, turn the instrument half-way around, reverse the telescope, clamp the instrument, and with the tangent screw bring the vertical wire again upon the near object; then draw in the objective until the distant object first sighted upon is brought into distinct vision. If the vertical wire strikes the same line as at first, the slide is correct for both near and remote objects and, being itself straight, for all distances.

But, if there be an error, proceed as follows: First, with the thumb and forefinger twist off the thin brass tube which covers the screws, C C, see page 7. Next, with the screw-driver, turn the two screws, C C, on the opposite sides of the telescope, loosening one and tightening the other so as to apparently increase the error, making, by estimation, one-half the correction required. Then go over the usual adjustment of the line of collimation and, having it completed, repeat the operation above described, first sighting upon the distant object, then finding a near one in line, and then reversing, making correction, etc., until the adjustment is complete.

This adjustment is always made by us before the instrument is shipped, is peculiar to our Transits, and, in our experience, furnishes the only way in which the line of collimation can be made correct for all distances.

The adjustments of the vertical circle and the level on telescope are described on pages 49-53.

THE ENGINEERS' TRANSIT.

THE LEVELING-HEAD of the Engineers' Transit is attached to the sockets by a screw and washer below ; it can be removed for cleaning and oiling, but should be in place when the instrument is in use or packed for transportation.

The circular plates with their accompanying sockets are shown in section on page 14. The upper plate, A A, carrying the compass-circle is screwed fast to the flange of the interior spindle ; the lower plate or divided limb, B, is fastened to the exterior socket, C, which again is fitted to and turns in the hollow socket of the leveling-head.

To take apart the Engineers' Transit : When it is necessary to separate the plates of the Transit, the Engineer should proceed as follows :

(1) Remove the screw and washer underneath which secure the spindle of the leveling-head to the sockets.

(2) Unscrew the nut which confines the spring in the thimble opposed to the tangent screw on the upper plate.

(3) Take out the three small screws which attach the tangent fixture to the upper plate. The plates can then be readily separated. To put the Transit together again, proceed exactly the reverse of the operation thus described.

The engraving, page 26, shows some of the attachments often used with the Engineers' Transit : the vertical **ATTACHMENTS** arc, level on telescope, and clamp and **TO TRANSITS.** tangent to telescope axis with gradienter screw. These and other appliances are used where leveling, taking vertical angles, etc., must be done in connection

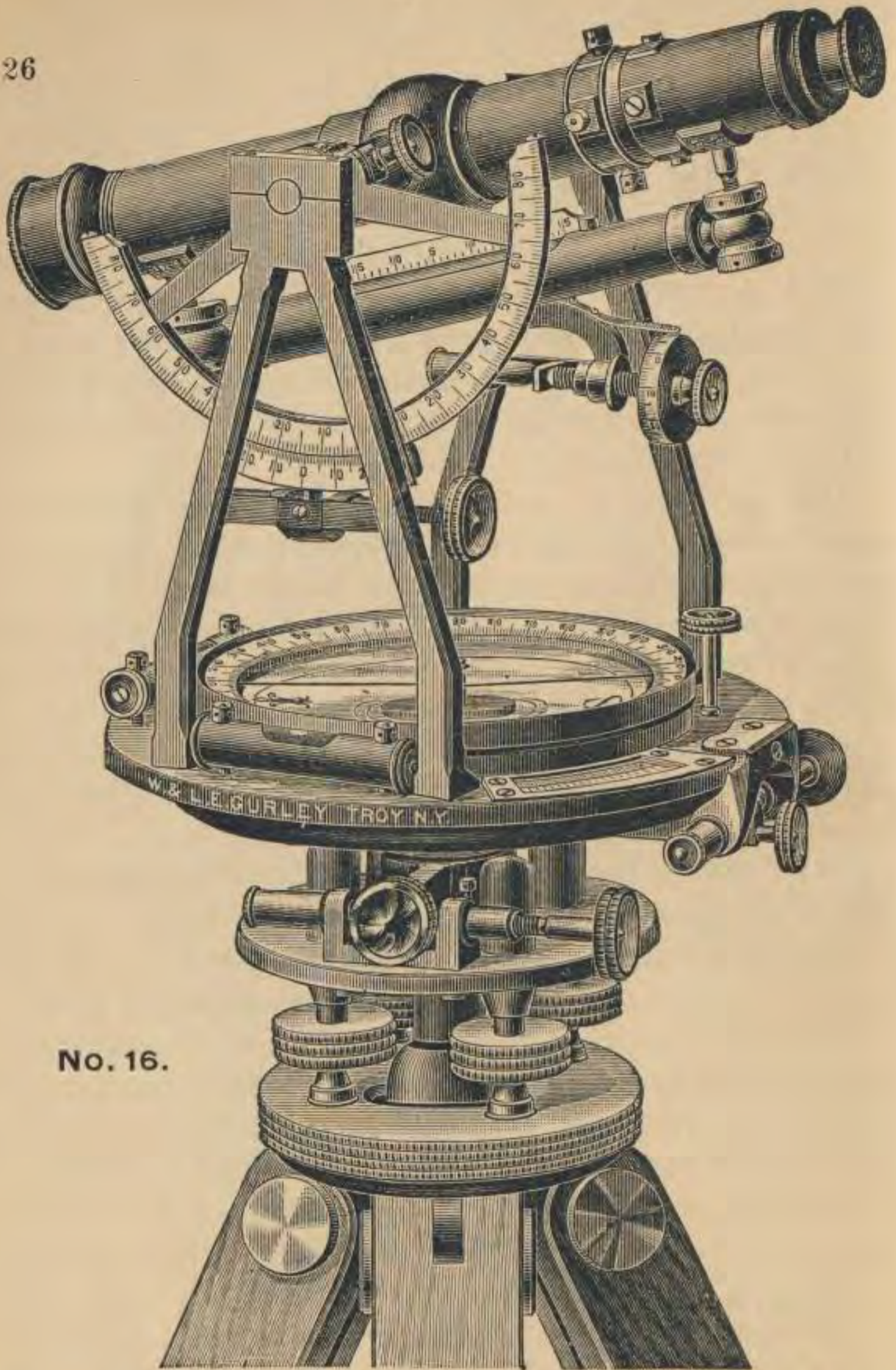

No. 16.

Engineers' Transit, 5-inch needle, with 6-inch vertical arc and vernier moved by tangent screw and reading to 30 seconds, level on telescope, gradienter combined with clamp and tangent, and tripod.
 Price as shown, \$198.00.

with the ordinary work of the Transit, and the attachments and their adjustments are described on pages 48-70.

We make three sizes of the Engineers' Transit, having
SIZES respectively four, four and one-half, and
AND WEIGHTS. five-inch needles; the average weight of each size, with plain telescope, is as follows:

4-inch needle, about.....	12½ lbs.
4½-inch needle, about.....	14 lbs.
5-inch needle, about.....	16 lbs.

The tripod furnished with this Transit weighs between nine and ten pounds.

ENGINEERS' TRANSIT WITH SOLAR ATTACHMENT.

The engraving on page 28 represents our Engineers' Transit with five-inch needle and attachments of vertical arc of three inches radius, divided on silver and reading to thirty seconds, level on telescope, clamp and tangent to telescope axis, and Solar apparatus with declination arc reading to thirty seconds.

The horizontal limb is divided on sterling silver, and reads to single minutes.

The compass-circle is also made movable, with pinion and clamp, for setting off the variation of the needle.

This variation arc is applied to Engineers' Transits of our make, at an extra cost of \$4, if requested when ordering the instrument.

Where the variation arc is desired with the addition of the new Solar Attachment to any Engineers' Transit sent to us for the purpose, a charge of \$15 will be made.

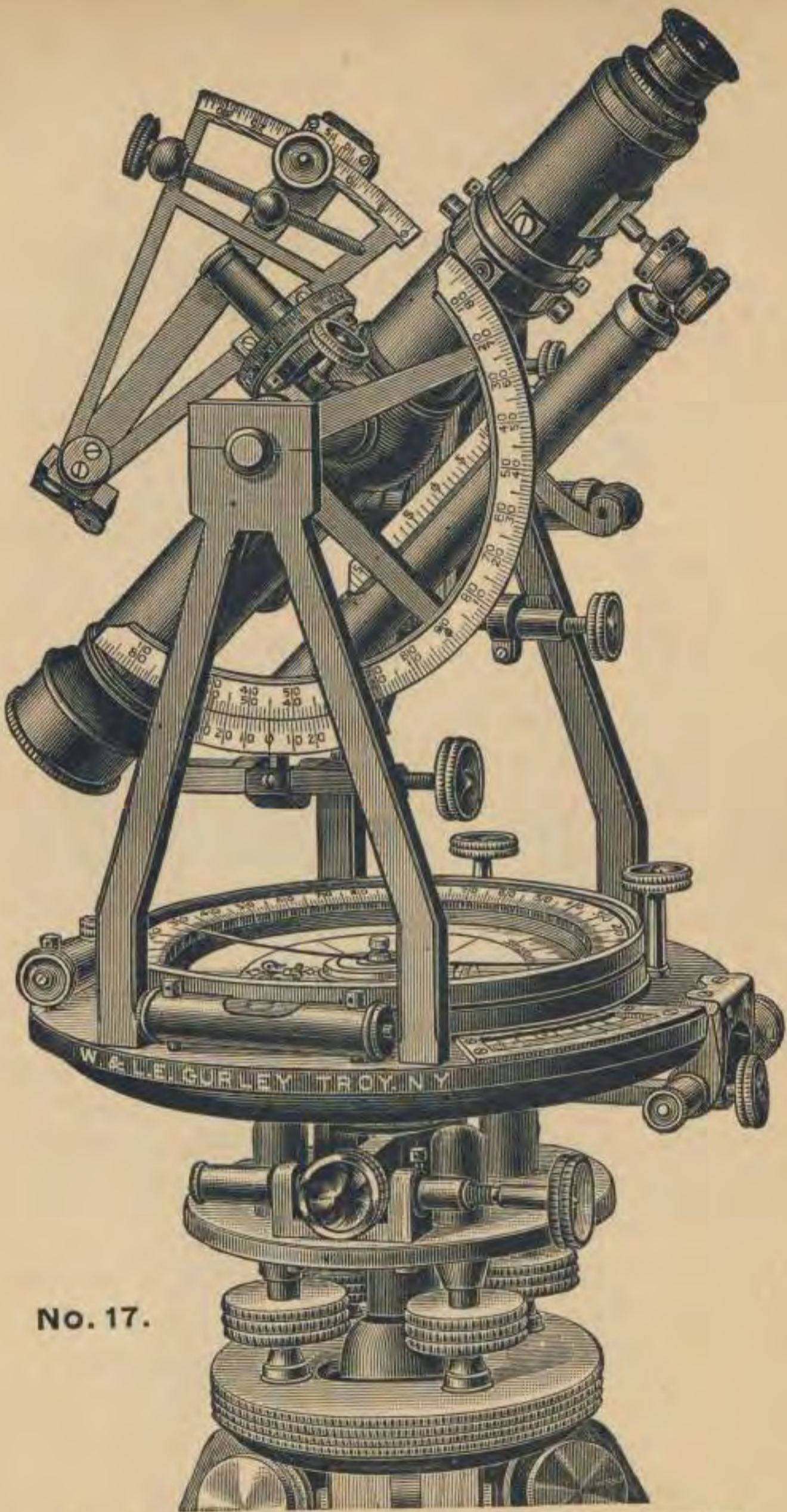

No. 17.

ENGINEERS' TRANSIT, WITH SOLAR ATTACHMENT
Price as shown, \$250.00.

LIGHT MOUNTAIN TRANSIT.

THIS instrument, shown on page 30, is a modification of the Engineers' Transit, designed for mountain and mine surveys, but applicable as well to all other work of the Engineer. It is exceedingly light and portable, its needle is four inches long, and its telescope is eight inches long with a power of twenty diameters.

The Sockets are like those shown on page 14, and, with the leveling-head, remain attached to the instrument; the compass-circle is movable about its center, so as to set off the variation of the needle.

SOCKETS.

As in our other Transits, the limb is graduated on sterling silver, reading usually to single minutes; but if desired it can be graduated to read to twenty or thirty seconds.

There are cylindrical caps above the leveling-screws to exclude dust, as in our other instruments.

The cut shows the celluloid reflectors, which are placed over the two opposite verniers of the limb, and are of special value in the surveys of mines, to throw light upon the divisions below.

Like the Engineers' Transit, the Mountain Transit is sometimes used with a plain telescope; **ATTACHMENTS FOR TRANSITS.** but oftener with one or more extras, as level, clamp and tangent and vertical arc, as shown.

Frequently, however, the Mountain Transit is furnished as shown on page 31, with vertical arc, level, clamp and tangent, and the Solar Attachment.

The Light Mountain Transit is almost always used upon our improved extension tripod (see page 175), the legs

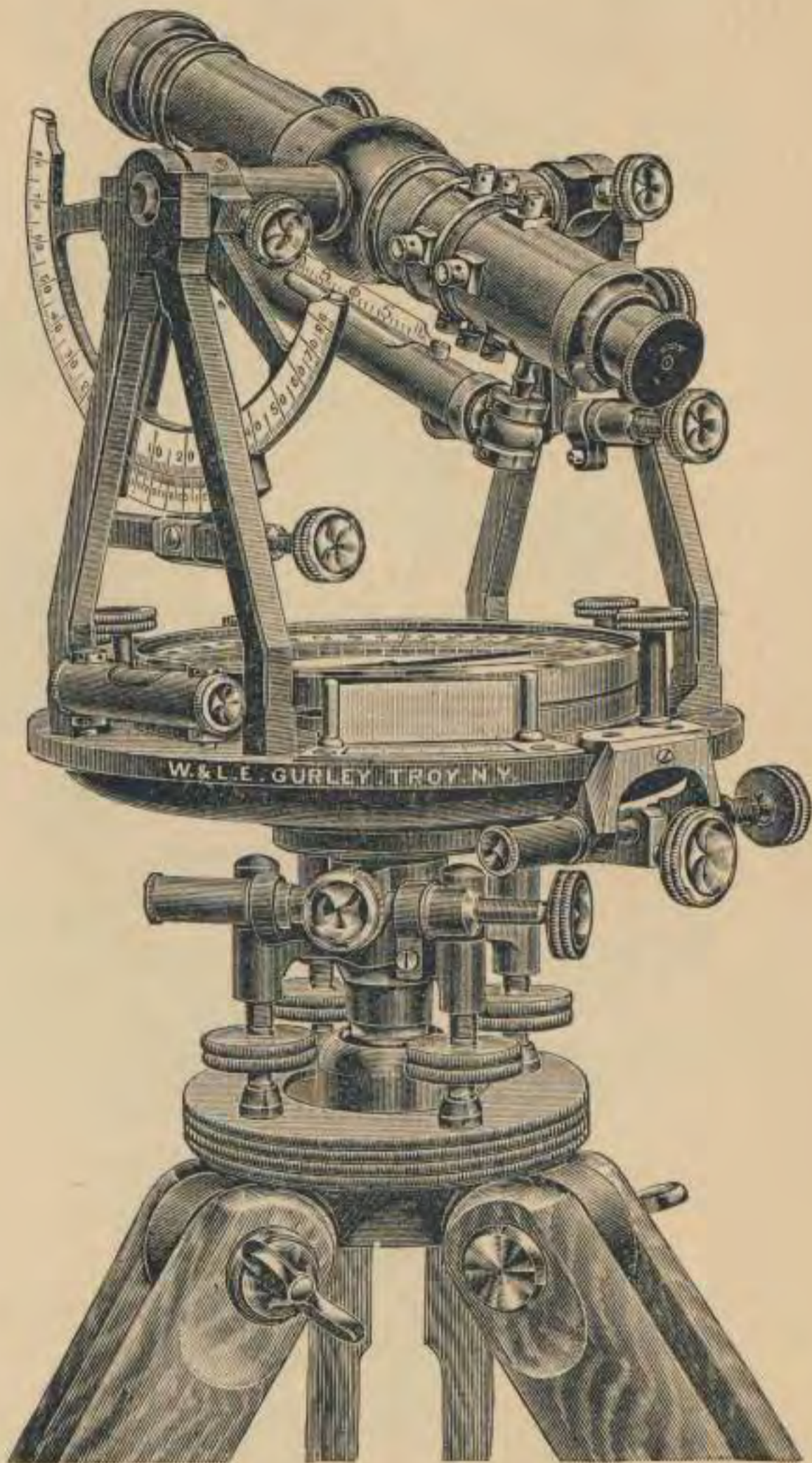
**No. 28.**

Light Mountain Transit with vertical arc, level on telescope and clamp and tangent to telescope axis, and extension tripod. Price, \$186.00.

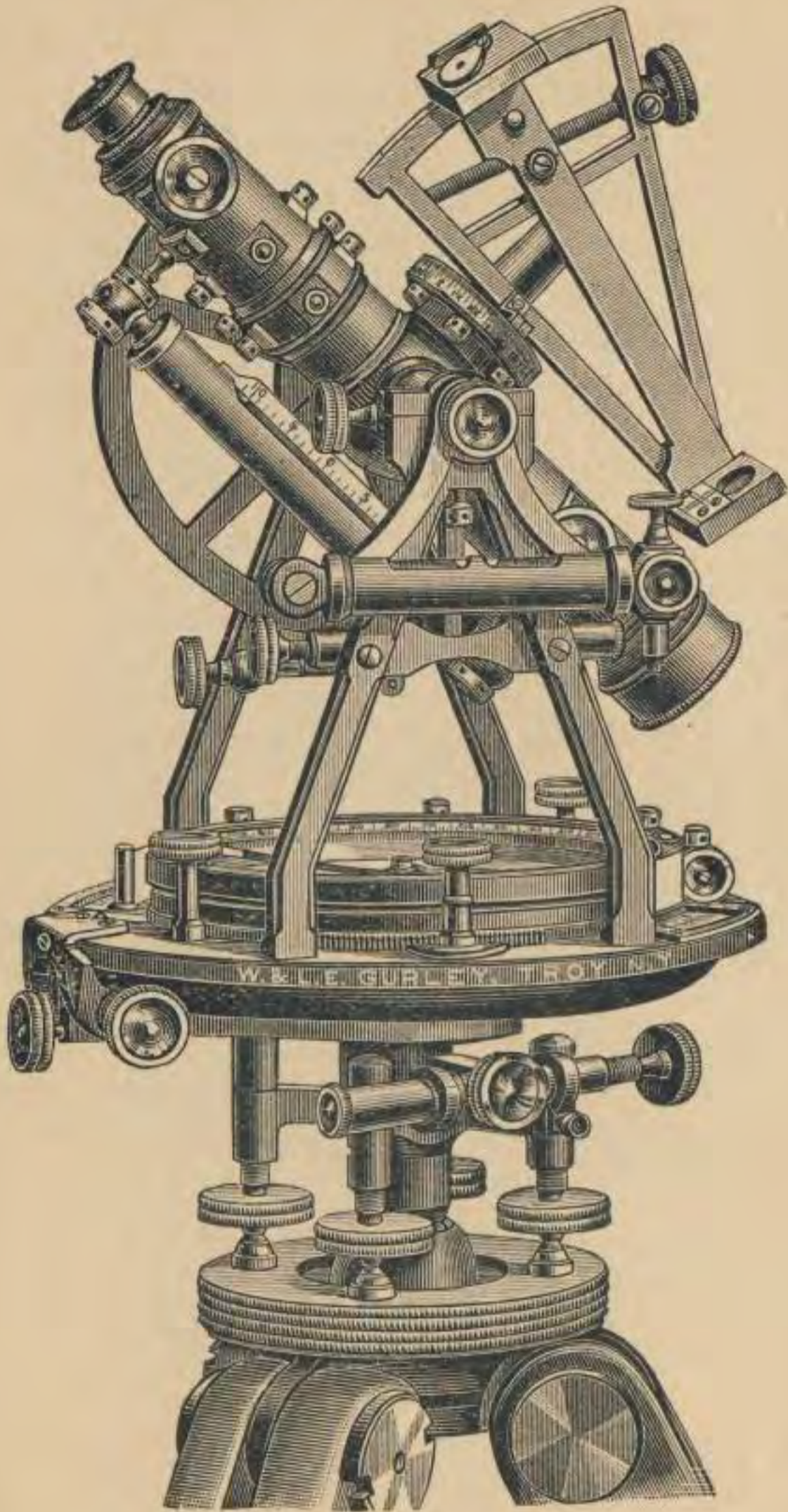

No. 30.

Light Mountain Transit, with solar attachment, vertical arc reading to 1 minute, level on telescope, and clamp and tangent to telescope axis, and extension tripod.
Price, \$245.00.

of which can be lengthened or shortened at will. It is thus adapted for use in mountain surveys, where one or more legs must be shortened ; or for mines, where in many places a short tripod is indispensable.

If desired, the sliding pieces can be easily turned end for end, the points being thus put out of the way and the tripod more easily transported. The tripod when closed is only three feet long, and is carried by a shawl strap, which we furnish with it.

The Light Mountain Transit, introduced by us in 1876 to meet a demand for a light instrument of the finest quality, has met with a very large sale, and has been universally approved.

While it is a Transit of first quality, adapted to all kinds of work which may be required, it is especially fitted for mining or mountain surveying where great portability is desired.

Besides the light mahogany box, in which the instrument is packed as usual, there is also supplied a light sole-leather case, furnished with shoulder-straps.

LEATHER CASE.

ment is packed as usual, there is also supplied a light sole-leather case, furnished

The weight of this instrument with plain telescope and without tripod is ten pounds ; with Solar Attachment, arc, level and clamp, as shown in the cut, twelve pounds. The extension tripod weighs about eight and one-half pounds.

WEIGHT.

THE SURVEYORS' TRANSIT.

THE Surveyors' Transit *with two verniers to limb* has essentially the same construction as the Engineers' Transit, but its compass-circle is movable about its center, like that of the Mountain Transit, in order that the variation of the needle may be set off in the surveys of old lines, or in running lines by the true meridian.

The arrangement of the sockets and leveling-head, however, permits the Surveyors' Transit to be detached from the leveling-head and replaced upon its spindle, when desired, without in any way disturbing its adjustments.

The sectional view, page 35, shows the interior construction of the sockets of the Transit, the manner in which it is detached from its spindle, and the means by which it can be taken apart if desired.

In the figure, the limb, B, is attached to the main socket, C, which is itself carefully fitted to the conical spindle, H, and held in place by the spring-catch, S.

The upper plate, A, carrying the compass-circle, standards, etc., is fastened to the flanges of the socket, K, which is fitted to the upper conical surface of the main socket, C; the weight of all the parts being supported on the small bearings of the end of the socket, as shown, so as to turn with the least possible friction.

A small conical center, in which a strong screw is inserted from below, is brought down firmly upon the upper end of the main socket, C, thus holding the two

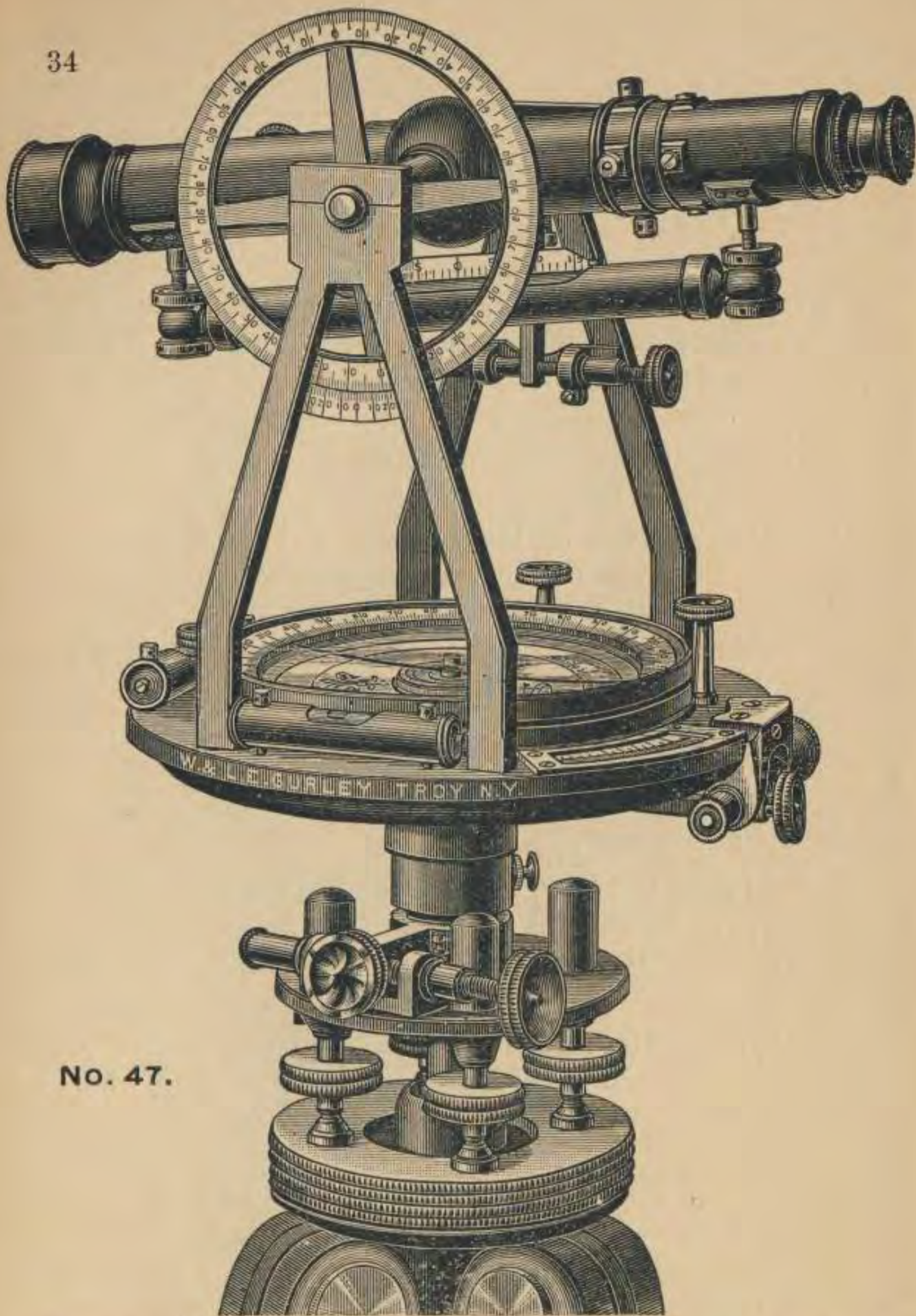

No. 47.

Surveyors' Transit, 5-inch needle, with $4\frac{1}{2}$ -inch vertical circle and vernier to 1 minute level on telescope, clamp and tangent to telescope axis, and tripod.
Price, \$160.00.

plates of the instrument securely together, and at the same time allowing them to move freely around each other in use.

A small disk above the conical center contains the steel center-pin upon which rests the needle, as shown; the disk is fastened to the upper plate by two small screws.

The clamp to limb, with clamp-screw, is also shown at D F, attached to the main socket below.

The main socket with all its parts is of the best bell-metal, and is most carefully and thoroughly made, the long bearing of the sockets insuring their firm and easy movement, while at the same time they are entirely out of reach of dust, or other source of wear.

When desired, the whole upper part of the instrument may be taken off from the spindle by pulling out the head

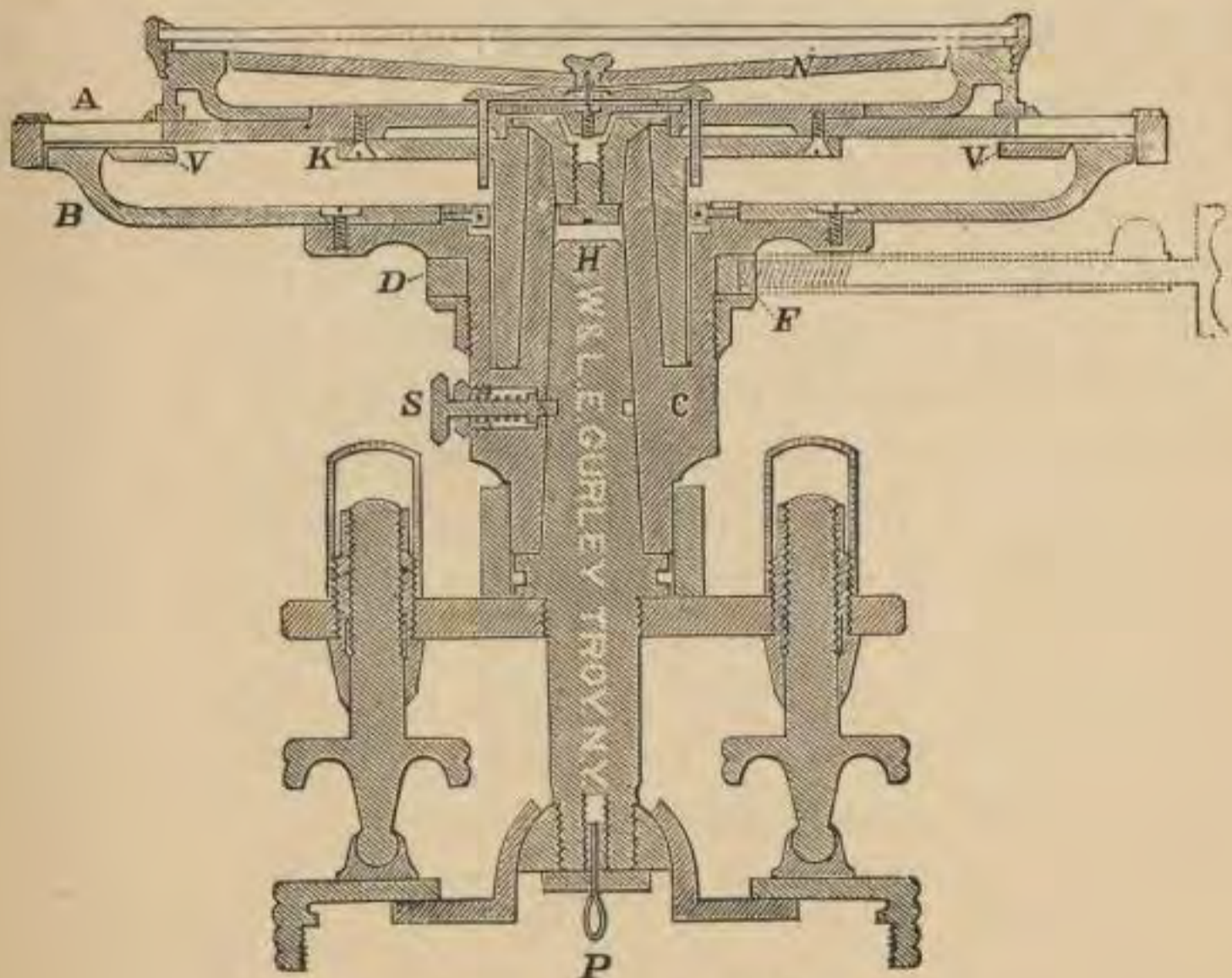

THE SOCKETS AND CIRCULAR PLATES.

of the spring-catch at S, and when replaced will be secured by the self-acting spring of the catch.

The figure also shows the covers of the leveling-screws, the shifting center of the lower leveling-plate, and the screw and loop for the attachment of the plummet.

TO TAKE APART THE SURVEYORS' TRANSIT.

When it is necessary to separate the plates of the Transit, proceed as follows (see page 35):

(1) Remove the clamp-screw of the variation arc and take off the head of the pinion, both outside the compass-circle. (2) Unscrew the bezel-ring holding the glass cover of the compass, remove the needle and button beneath it, and take out the two small screws so as to remove the disk. (3) Take the instrument from its spindle, and with a large screw-driver take out the screw from the under side of the conical center. (4) Drive out the center from below by a round piece of wood, holding the instrument so that the center will not bruise the circle. (5) Set the instrument again upon its spindle, unscrew the milled head cap from the thimble containing the opposing spring of the tangent movement to limb, take out the three screws which fasten that movement to the upper plate, and the plates can then be separated. To put the Transit together again, proceed exactly the reverse of the operation thus described.

SIZES AND WEIGHTS. The sizes and weights of the Surveyors' Transits with plain telescope, and having two verniers to limb are :

4-in. needle, with leveling-head, but no tripod, about	13 $\frac{3}{4}$ lbs.
5-in. needle, " " " " " "	16 $\frac{1}{2}$ lbs.
5 $\frac{1}{2}$ -in. needle, " " " " " "	17 $\frac{1}{2}$ lbs.

The Surveyors' Transit *with one vernier to limb* is a modification of the instrument just described, in which there is but one double vernier to limb and a different arrangement of the sockets, as shown in the sectional cut on page 39.

The instrument is more compact and somewhat lighter than that with two verniers, and is furnished at less cost. Its graduations, telescope and attachments are all equal to those of the best Transits; and after an experience of more than twenty-five years the instrument has proved itself in every way satisfactory for all classes of work.

This instrument may be taken apart by first removing the pinion head and clamp-screw near the compass-circle, then unscrewing the bezel-ring, taking out the needle and button underneath, and next removing the disk in which the center-pin is fixed, by taking out two small screws which confine it. The four screws which hold the washer to the under plate must then be removed, the milled head cap of the tangent opposing spring be unscrewed, and the three screws which secure the tangent support to the upper plate removed; and then the plates can be separated. The several parts are replaced in the reverse order.

The adjustments and use of this instrument are like those of the others already described, and its attachments to the telescope the same, if desired.

It is represented in the cut with a level on telescope and clamp and tangent to telescope axis. (See page 38.)

The sectional cut, on page 39, shows the arrangement of the sockets of this instrument. The spin-
THE dle, C, is fitted to the socket of the leveling-
SOCKETS. head, as shown, and connected therewith by a screw and washer underneath, as in the figure.

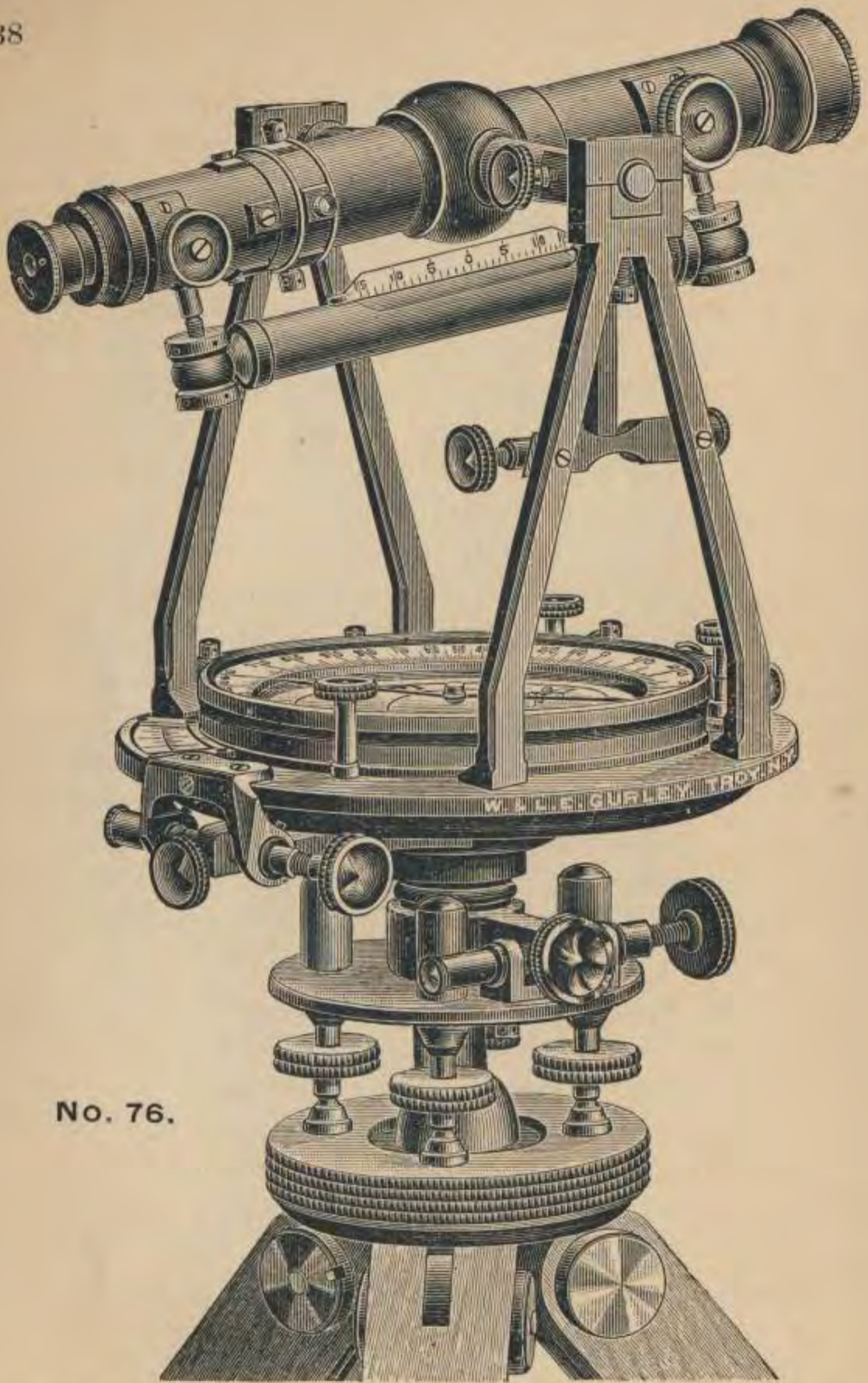

No. 76.

Surveyors' Transit, 5-inch needle, with level on telescope, clamp and tangent to telescope axis, and tripod.

Price, \$133.00.

The socket, K, is formed in the metal of the upper plate, a strong washer with four screws, only two of which are seen in the cut, keeping the two plates together, but at the same time allowing them to turn freely around each other.

The clamp to limb, with clamp-screw, is shown in dotted lines at D F, under the plates.

The vernier with the opening above is shown on the left at A. The arrangement of the center-pin, needle, etc., is like that of the Transit with two verniers, but the instrument remains attached to the leveling-head like the Engineers' Transit.

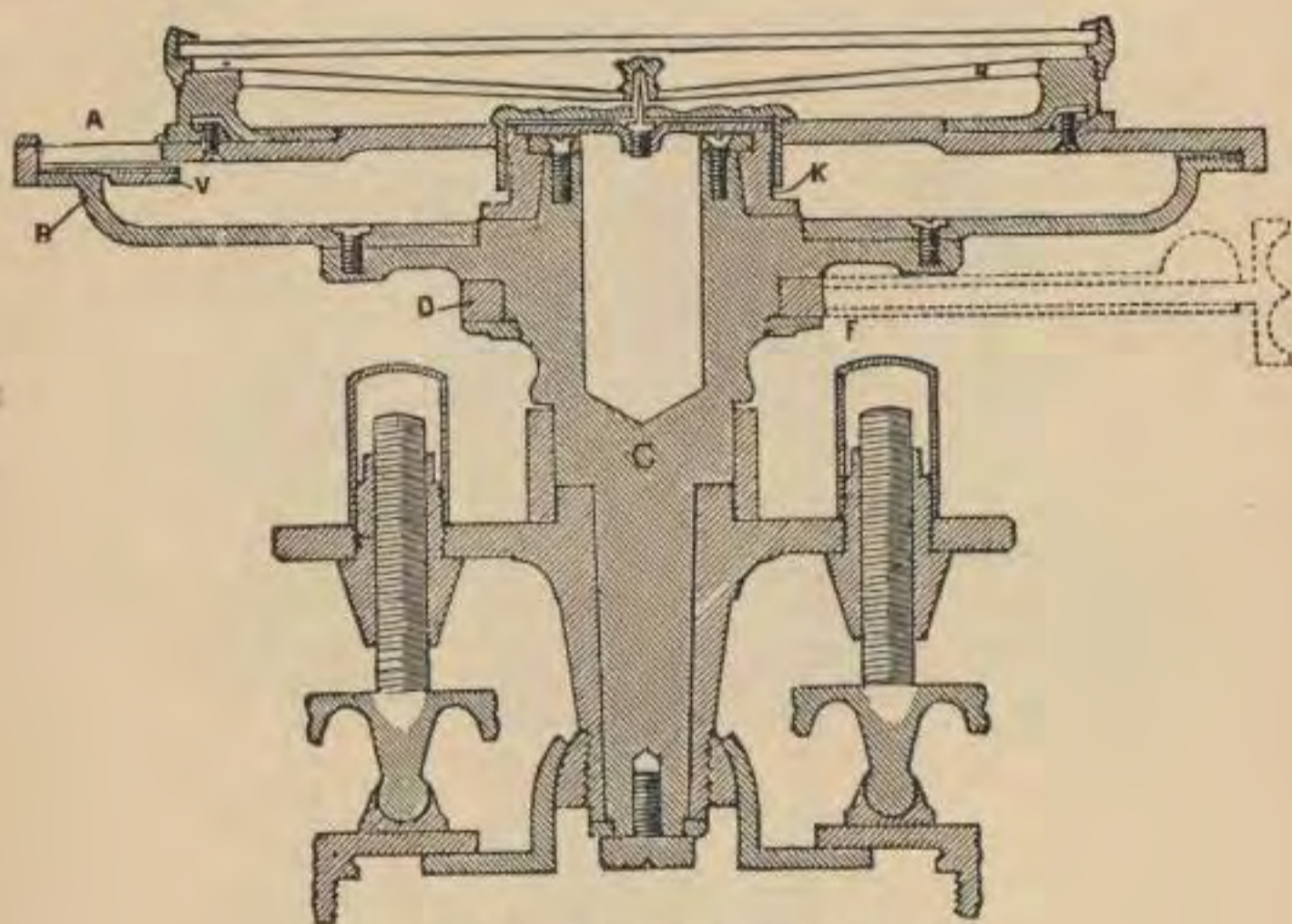

THE SOCKETS AND CIRCULAR PLATES.

SIZES AND WEIGHTS. The sizes and weights of the Surveyors' Transits with plain telescope, and having one vernier to limb are :

4-in needle, with leveling-head, but no tripod,	about	13 lbs.
5-in needle, " " " " " "	" "	16 lbs.
5½-in. needle, " " " " " "	" "	17 lbs.

SURVEYORS' TRANSIT WITH SOLAR ATTACHMENT.

The engraving on page 41 represents our Surveyors' Transit with five-inch needle, to which is adapted the Solar Attachment, with vertical arc, level, etc. ; both the vertical arc and the arc of the declination arm being graduated on silver and reading by vernier to thirty seconds.

The instrument is furnished with two verniers to limb or with one vernier to limb, as may be desired ; both patterns have shifting center to the tripod head.

PRICES.

No.		PRICE.
60.	Surveyors' Transit, two verniers to limb, 5-inch needle, with Solar Attachment, vertical arc, level on telescope, clamp and tangent to telescope axis, and tripod.....	\$226.00
90.	Surveyors' Transit, one vernier to limb, 5-inch needle, with Solar Attachment, vertical arc, level on telescope, clamp and tangent to telescope axis, and tripod.....	211.00

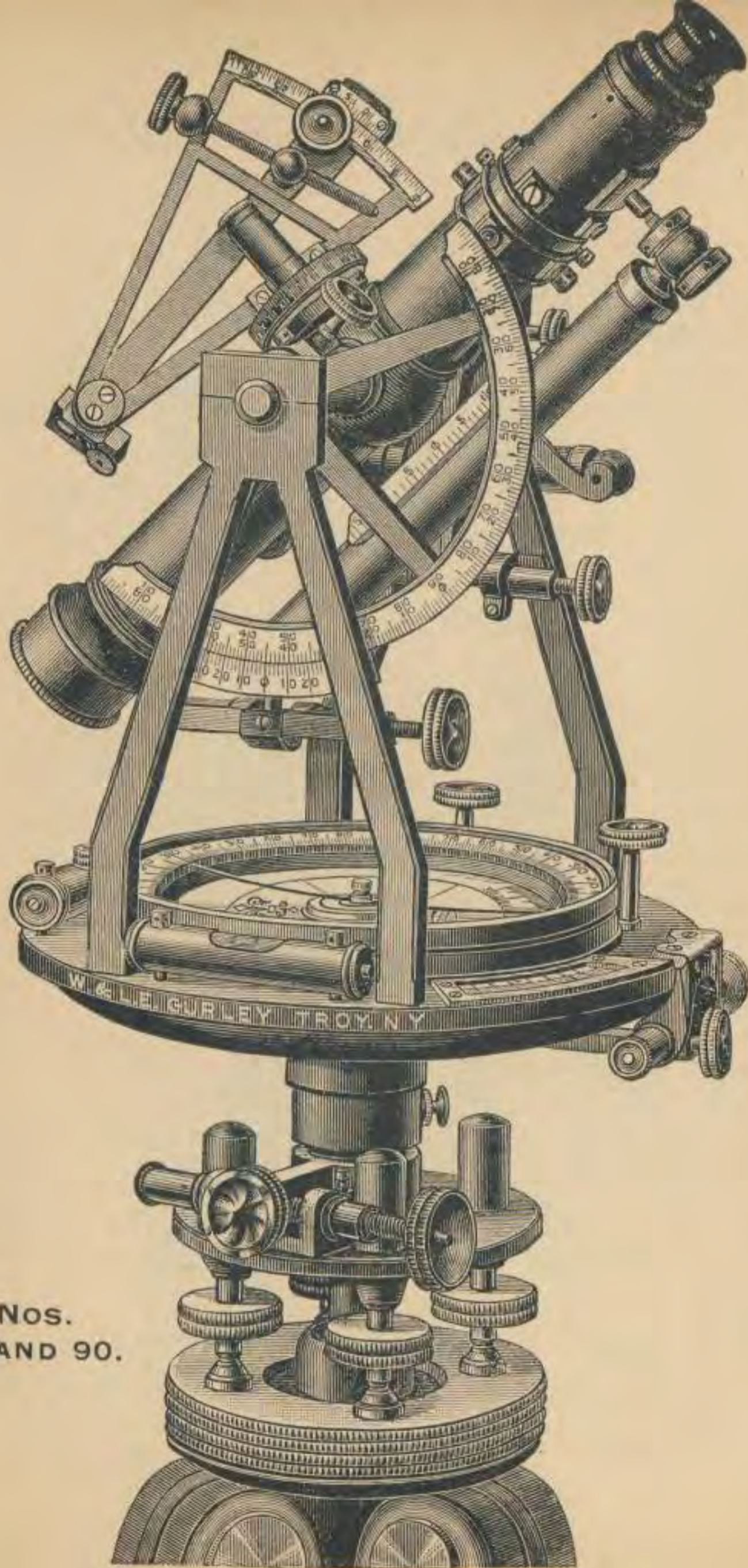

NOS.
60 AND 90.

THE RECONNOISSANCE TRANSIT.

IN RESPONSE to a demand for a very light Transit for rapid work, where extreme accuracy is not required, we have introduced the Reconnaissance Transit, shown on page 43.

It has a needle three and one-half inches in length, a limb five inches in diameter, graduated on sterling silver, reading by one double vernier to single minutes, and is provided with a spring tangent movement like the larger instruments.

The limb is figured from 0 to 180 unless otherwise ordered.

The telescope has a power of from eighteen to twenty diameters, and is furnished with stadia wires for measuring distances; it has also a long level, vertical circle reading to five minutes, and clamp and tangent to axis.

The compass-circle is arranged to set off the variation of the needle, the movement being made by a pinion.

The instrument has also, as shown, a leveling-head with shifting center, and with spring clamp and tangent, and it is set upon our light extension tripod, the legs of which close up to about three feet in length.

This instrument is finished with the same care as our larger and more expensive Transits, and we recommend it as a thoroughly well made and reliable instrument for a large variety of work. The quality of the instrument, together with its portability, have already made it very popular.

The weight of this Transit without the tripod is about seven and three-quarter pounds, complete with tripod about fifteen pounds.

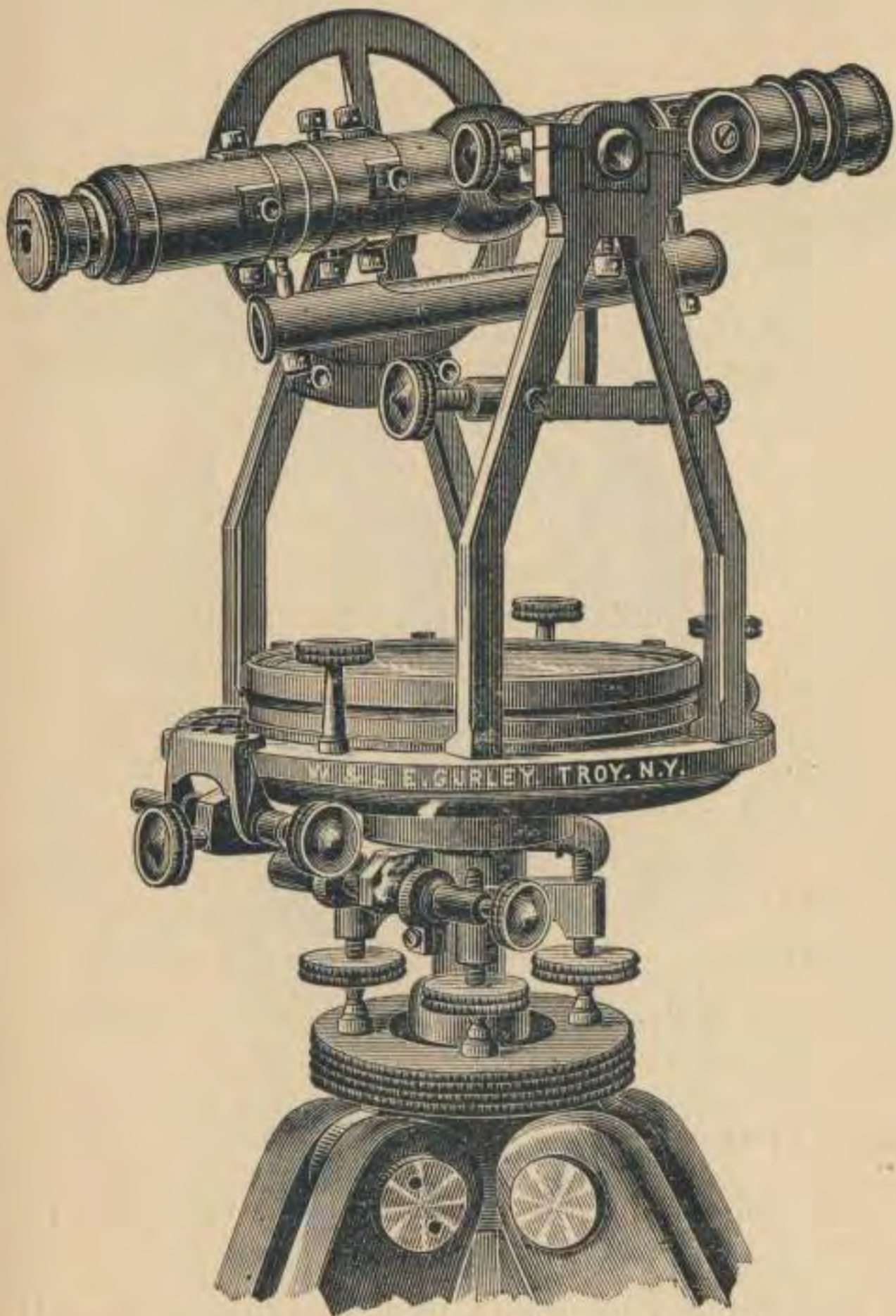

No.	No. 100.	Price.
100.	Reconnaissance Transit, one vernier to limb, $3\frac{1}{2}$ -inch needle, with $3\frac{1}{2}$ -inch vertical circle and vernier reading to five minutes, level on telescope, clamp and tangent to telescope axis, and leveling tripod with extension legs.....	\$115.00
102.	Reconnaissance Transit, same as No. 100, but with $4\frac{1}{2}$ -inch vertical circle and vernier reading to one minute.....	122.00

THE BUILDERS' TRANSIT.

THE Builders' Transit, see page 45, is an instrument devised for use in the construction of buildings where it is necessary not only to furnish levels, but to determine points in a vertical plane above or below the level line, or on either side and in line with the center of the instrument, more conveniently than can be done with the Architects' Level. The instrument has a telescope with long graduated level, clamp and tangent to axis, a graduated limb reading by an index to one degree, clamp and tangent to both limb and leveling-head, a plain tripod and trivet-plate.

In use the instrument is set up either upon the tripod or trivet, and the plates are accurately leveled by the two levels shown.

If it is desired to run a level line, the bubble of the telescope level is brought into the middle by the clamp and tangent of the axis, in which position the
LEVEL LINE. horizontal wire of the telescope will determine a level line, as in the telescope of the ordinary Level, and any angle desired may be read off upon the limb.

When necessary to obtain points in a vertical plane,
VERTICAL LINE. either above or below a given point, the plates should be clamped and the clamp of the telescope axis released, when the telescope may be directed either above or below to the point desired.

To determine two points in a straight line with the instrument and on opposite sides of its
STRAIGHT LINE. center, direct the telescope to one of the points, then clamp the plates, and the other point may be obtained by reversing the telescope upon its axis.

The weight of the Builders' Transit is about seven pounds; and with the tripod complete about thirteen pounds.

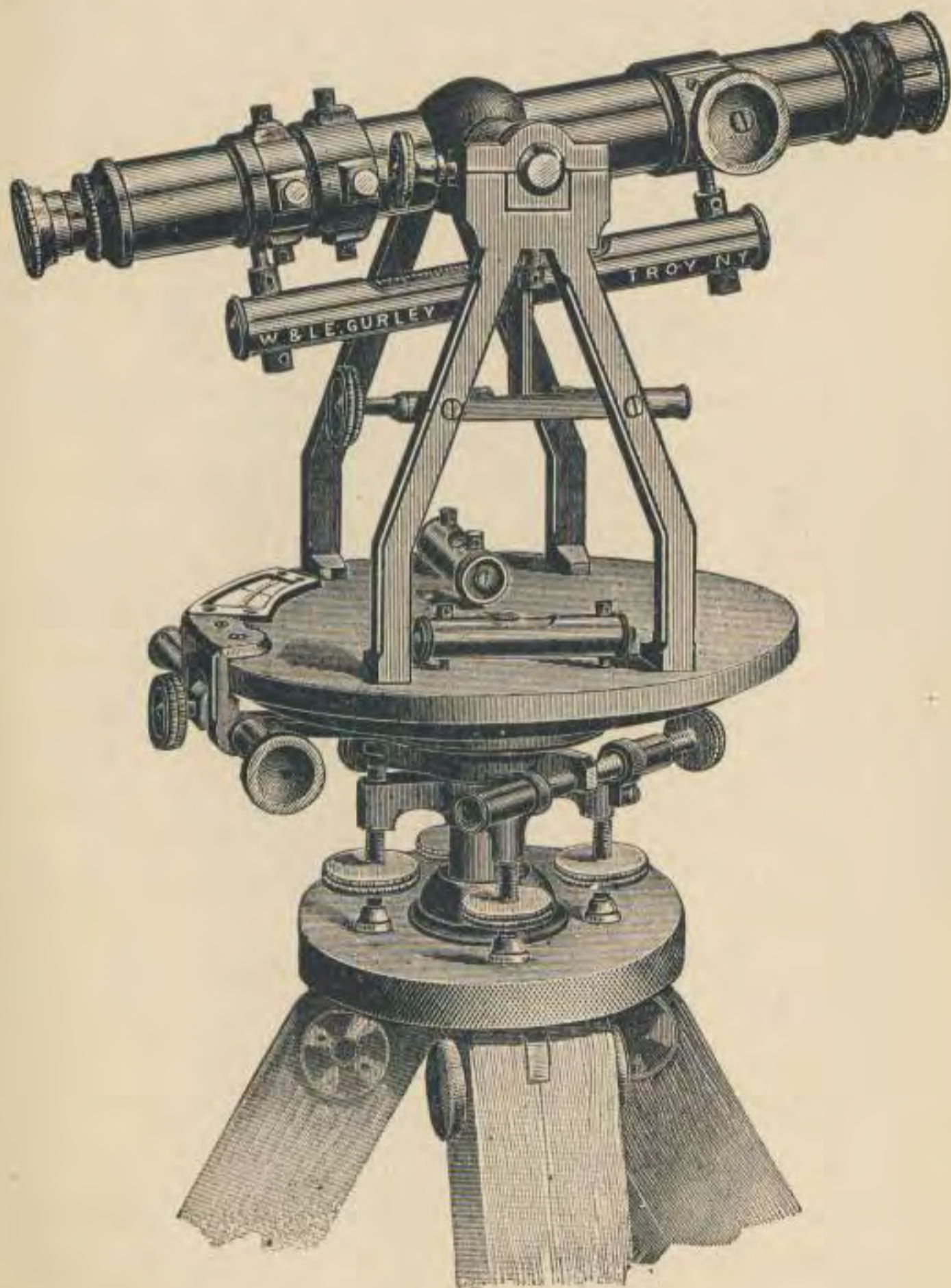

No. 105.

Builders' Transit, with level on telescope, clamp and tangent to telescope axis, limb and spindle, and with leveling-screws and tripod, as shown.

Price, \$80.00.

THE VERNIER TRANSIT-COMPASS.

THIS instrument, shown on page 47, is essentially a Vernier Compass with a telescope in place of the ordinary sight-vanes, thus giving the Surveyor the means of taking long sights, either on a level or on hilly ground, with ease and accuracy.

The telescope can also be supplied with attachments, as shown, and levels and angles of elevation and depression taken, as with the more expensive instruments.

The telescope is eleven inches long and of fine quality.

The compass-circle is moved about its center by a pinion placed underneath the circular plate, and the variation of the needle is set off to single minutes upon a divided arc attached to the plate, as shown in the cut. There is also a clamp-screw by which the circle is made fast.

The figure represents the instrument with six-inch needle; in the smaller size the vernier of the compass-circle is within the box and under the glass, as in the Surveyors' Transit.

The needle-lifting screw is also underneath the plate, but is not shown in the cut.

The clamp-screw, by which the instrument is fixed to the spindle, and the spring-catch which secures it, are both shown on opposite sides of the socket.

The levels are both above the plate, and are made adjustable by capstan-head nuts at either end.

This instrument is commonly used on a ball-spindle placed in a compass tripod, as shown on page 47, but it is sometimes fitted to a leveling-head like that of the Surveyors' Transit shown on page 34.

SIZES AND WEIGHTS. We make two sizes of this instrument, having respectively five and six-inch needles, the average weights of which are as follows :

5-inch needle, plain telescope, and without tripod, 9 lbs.
 6-inch needle, " " " " " " 11 $\frac{3}{4}$ lbs.

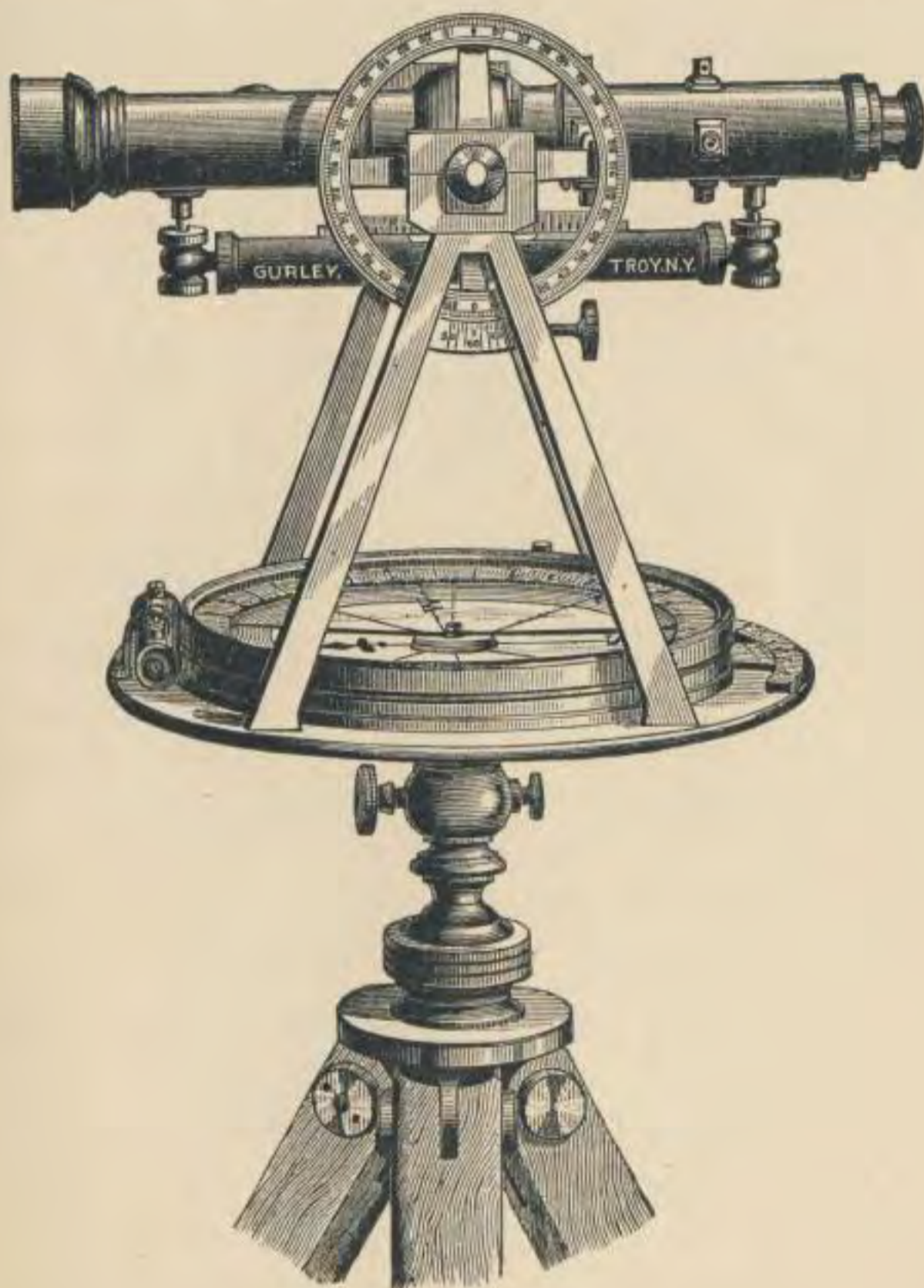

No. 117.

Vernier Transit, 6-inch needle, with 3 $\frac{1}{2}$ -inch vertical circle and vernier reading to 5 minutes, level on telescope, clamp and tangent to telescope axis, and tripod.
 Price, \$101.00.

ATTACHMENTS FOR TRANSITS.

IN THE use of the Transit it is generally found advisable to add one or more attachments to the telescope. All our Transits and their attachments are now made to standard sizes, so that one or more of these useful appliances can be fitted to the instrument at any time without additional expense other than the cost of the attachment itself.

When any of these attachments are desired, either for our instruments or those of other makers, it is best to send the instrument to us; in some cases they can be applied by a skilful mechanic nearer the customer, but this is generally more expensive and less satisfactory.

The principal attachments for the Transit are :

VERTICAL CIRCLE, (see pages 49 and 50).

VERTICAL ARC, (see page 51).

LEVEL ON TELESCOPE, (see page 52).

CLAMP AND TANGENT to Telescope Axis, (see pages 52 and 54).

SIGHTS ON TELESCOPE, (see page 54).

SIGHTS ON STANDARDS for Right Angle Observation, (see page 54).

ATTACHED MAGNIFIERS to Horizontal Limb, (see page 54).

GRADIENTER, combined with Clamp and Tangent, (see page 55).

DETACHABLE TELESCOPES for Vertical Sighting, (see page 57).

REFLECTOR for Illuminating the Cross-Wires, (see page 58).

DIAGONAL PRISM for Eyepiece of Telescope, (see page 58).

PLUMMET-LAMP, (see page 59).

QUICK-LEVELING ATTACHMENT, (see page 60).

SOLAR ATTACHMENT to Telescope, (see pages 61-71).

THE VERTICAL CIRCLE.

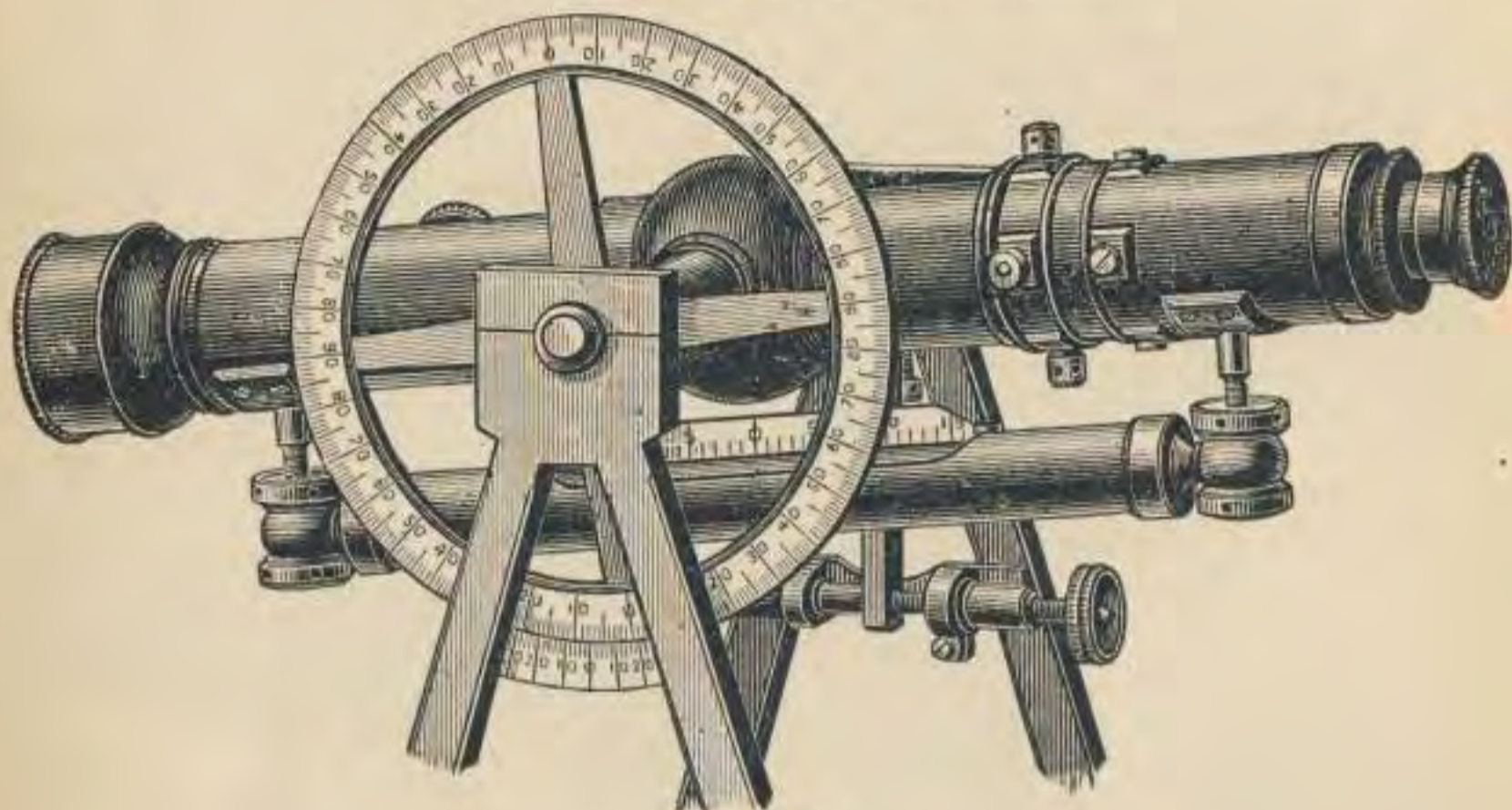

No. 136.

The Vertical Circle has its divisions on sterling silver and is figured from 0 to 90; two sizes are most commonly used, the three and one-half-inch circle reading by vernier to five minutes, as shown in Fig. 117, and the four and one-half-inch circle reading by vernier to single minutes, as shown in Fig. 136.

We also make these circles five inches in diameter when desired, reading to one minute.

To adjust the Vertical Circle: Having the instrument firmly set up and carefully leveled, bring into line the zeros of the circle and vernier, and with the telescope find some well-defined point, from one hundred to five hundred feet distant, which is cut by the horizontal wire. Turn the instrument half-way around, reverse the telescope, and fixing the wire upon the same point as before, observe if the zeros are again in line. If not, loosen the capstan-head screws which fasten the

ADJUSTMENT.

vernier, and move the zero of the vernier over half the error; bring the zeros again into coincidence, and proceed exactly as before, until the error is entirely corrected, when the adjustment will be complete. In almost all cases the error is slight, and may be most readily removed by putting the zeros in line and then moving the horizontal wire by the vertical capstan-head screws over half the interval.

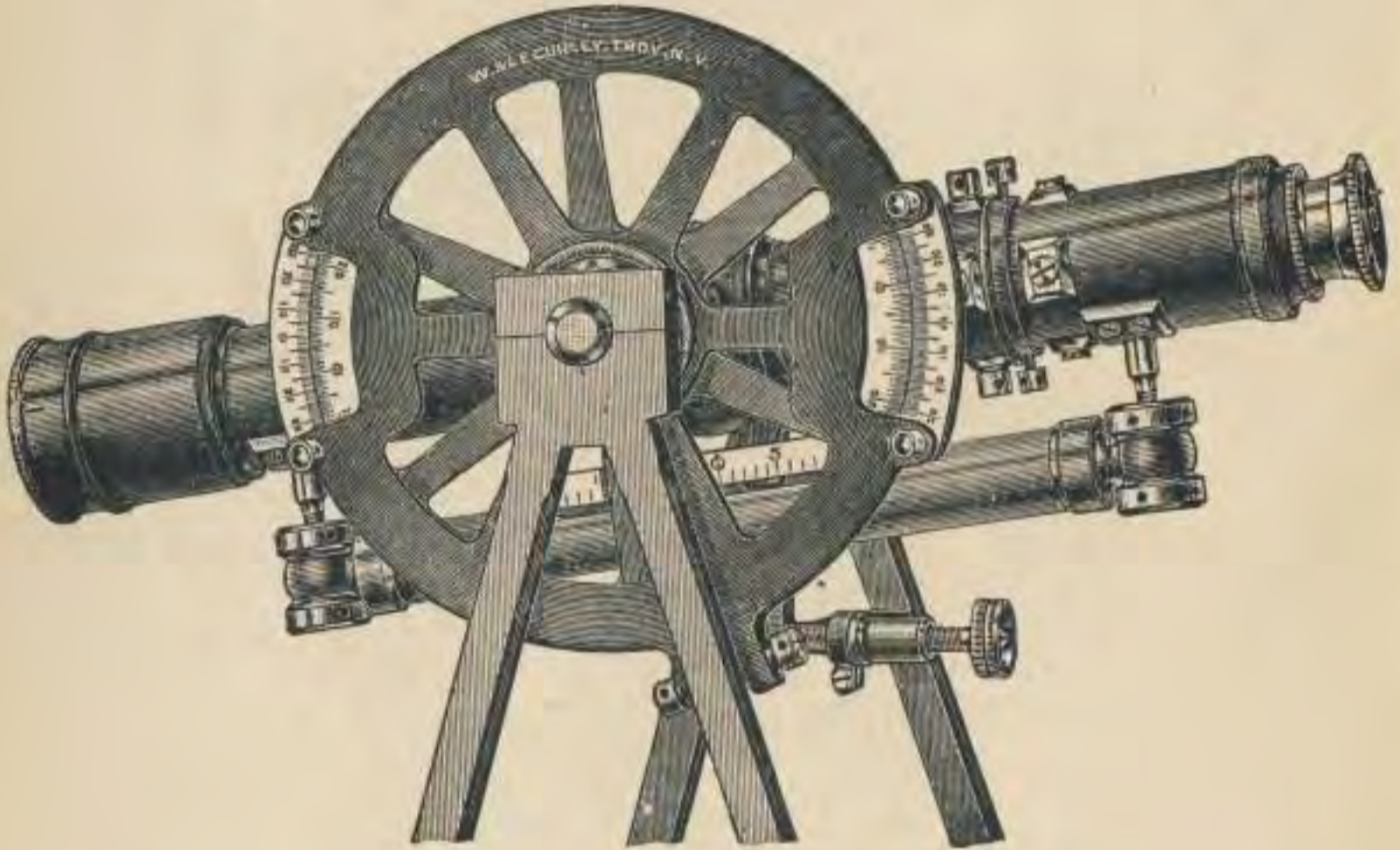

No. 138.

We also make a modification of the five-inch circle, shown in Fig. 138, enclosed in outside shield, fastened to which are two opposite verniers reading to single minutes, the arm projecting from the lower side being actuated by a capstan-head screw, as shown in the cut, to bring the zeros of the verniers into exact adjustment.

PRICES.

No.					
135.	3½-inch	Vertical Circle.....			\$ 8.00
136.	4½-inch	“ “			12.00
137.	5 -inch	“ “			15.00
138.	5 -inch	“ “ with two opposite double verniers..			35.00

ATTACHMENTS FOR TRANSITS.

THE VERTICAL ARC.

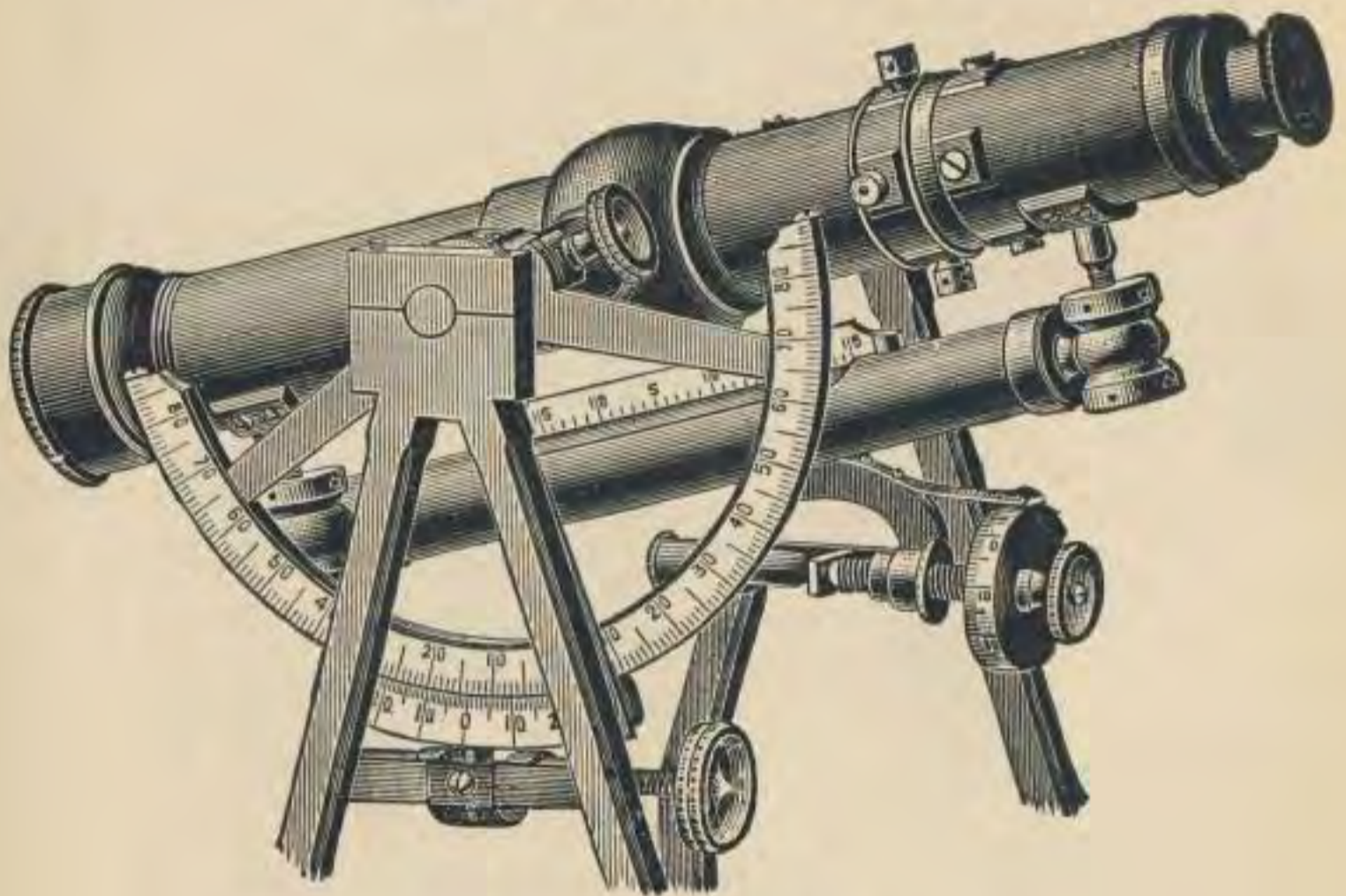

NOS. 139 AND 140.

The Vertical Arc is made in two sizes, two and one-half and three inches radius, graduated on sterling silver and read by a vernier swung from the axis and movable by a tangent screw.

The arc is movable around its bearing on the axis, can be readily clamped by the clamp-screw and set at 0 with the vernier in any position of the telescope, and any degree of elevation can be read off directly on the arc.

The arc of two and one-half inches radius is generally used on the Light Mountain Transit, and reads by its vernier to single minutes, while the arc of three inches radius is commonly used on the larger Transits, and is read by the vernier to thirty seconds. The Vertical Arc can be readily added to any Transit of our manufacture.

Price of the Vertical Arc, either size..... \$18.00

THE LEVEL ON TELESCOPE, AND CLAMP AND TANGENT TO TELESCOPE AXIS.

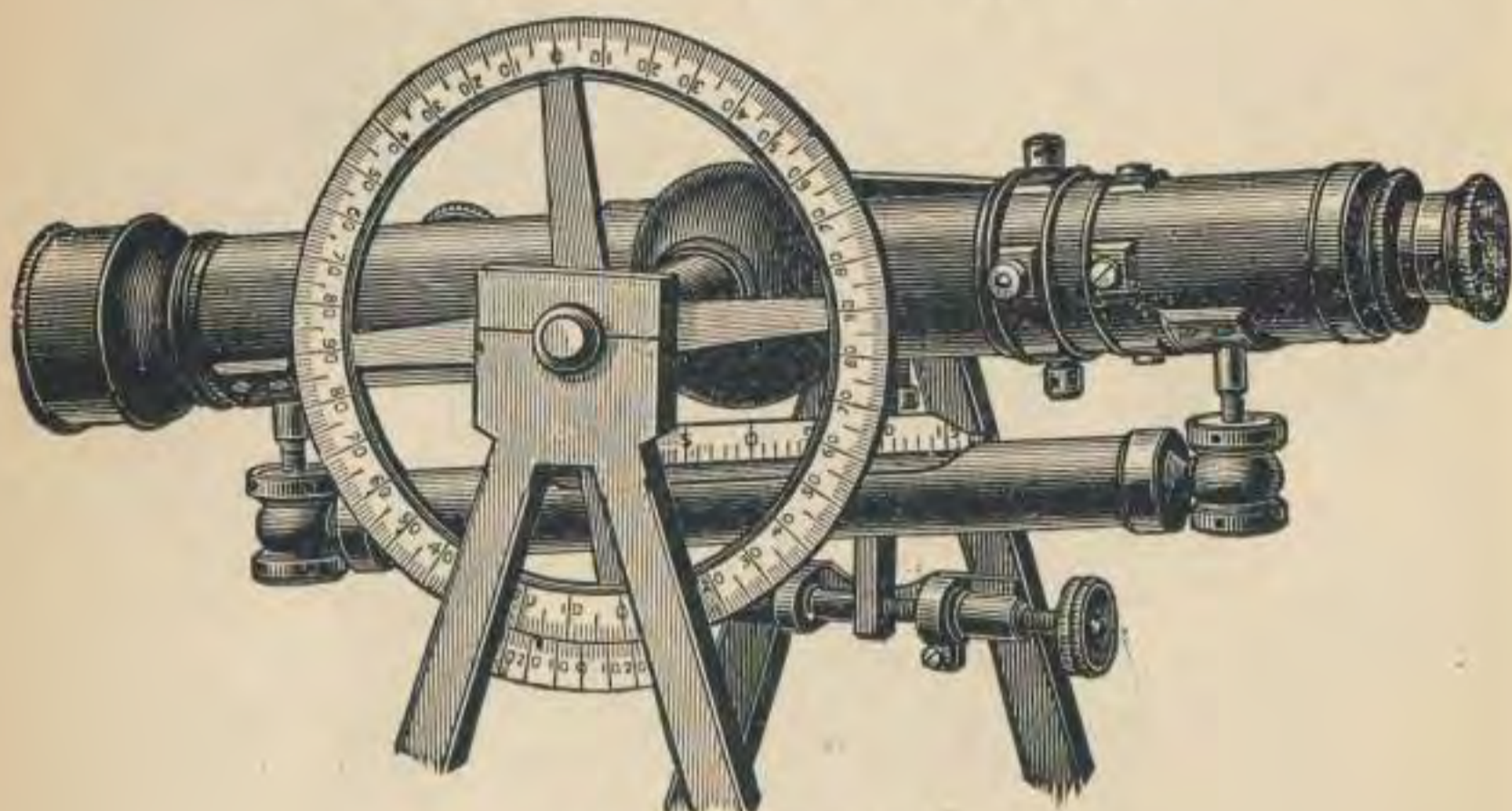

NOS. 145 AND 148.

The Level on Telescope, No. 145, consists of a brass tube about six and one-half inches long, each end of which is held between two capstan nuts connected with a screw or stem attached to the under side of the telescope tube.

The vial enclosed in the tube is a little over five inches long and half an inch in diameter, is ground on its interior surface so as to insure an even and sensitive bubble, the length of which is measured by the divided scale above; the scale is divided into tenths of an inch, and is figured from 0 at the middle to 5, 10, 15, 20 on either side, and thus determines when the bubble is brought into the middle of its run.

Price of Level on Telescope \$12.00

To adjust the Level on Telescope: When the vernier of the vertical circle is adjusted as per **ADJUSTMENT.** page 49, and is at zero, the line of collimation is level and the bubble may be brought into the

middle of its run by the capstan-head nuts. Another method: First level the instrument carefully, and with the clamp and tangent movement to the axis make the telescope horizontal, as near as may be, by the eye; then, having the line of collimation previously adjusted, drive a stake at a convenient distance, say from one hundred to three hundred feet, and note the height cut by the horizontal wire upon a staff set at the top of the stake.

Fix another stake in the opposite direction and at the same distance from the instrument, and without disturbing the telescope turn the instrument upon its spindle, set the staff upon the stake, and drive the stake into the ground until the same height is indicated as in the first observation.

The top of the two stakes will then be in the same horizontal line, however much the telescope may be out of level.

Now remove the instrument from fifty to one hundred feet to one side of either of the stakes and in line with both; again level the instrument, clamp the telescope as nearly horizontal as may be, and note the heights indicated upon the staff placed first upon the nearest and then upon the most distant stake. If both agree, the telescope is level; if they do not agree, then with the tangent screw move the wire over nearly the whole error, as shown at the distant stake, and repeat the operation just described. Proceed thus until the horizontal wire will indicate the same height at both stakes, when the telescope will be truly horizontal. Taking care not to disturb the position of the telescope, bring the bubble into the middle by the little leveling-nuts at the end of the tube, when the adjustment will be complete.

THE CLAMP AND TANGENT.

The Clamp and Tangent, No. 148, consists of an arm at one end encircling the telescope axis, and at the other end connected with the tangent screw; the clamp is fastened at will to the axis by a clamp-screw inserted at one side of the ring, and then by turning the tangent screw the telescope is raised or lowered as desired.

The clamp and tangent must always accompany the vertical circle and level on telescope, whenever either is added to a Transit. Price, \$6.00.

SIGHTS ON TELESCOPE AND ON STANDARDS.

For convenience of observation we occasionally place a pair of small sights on the telescopes of our Transits. These sights have folding joints, so that they may lie close to the telescope when not in use. Sights are also placed on the standards at an angle of ninety degrees with the telescope, for use in offsetting.

Price of either style, per pair.....\$8.00

Attached Magnifiers are frequently used over the verniers of the horizontal or vertical arc, and are held by a universal jointed arm which allows the lens to be placed at will over any point of the vernier. Price, each, \$5.00.

MAGNIFIERS.

GRADIENTER.

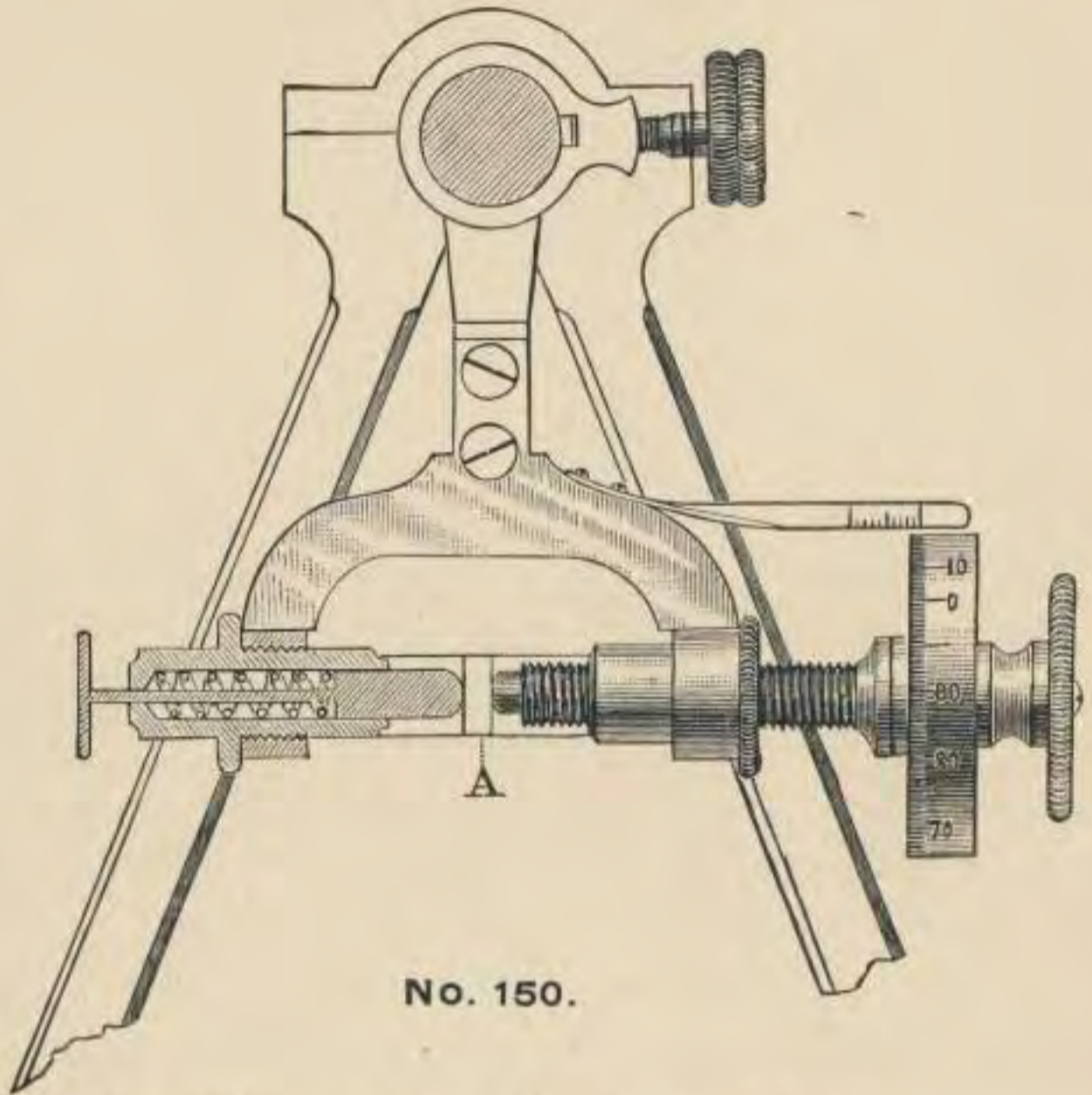

GRADIENTER ATTACHMENT. Price, \$18.00.

This attachment, as shown, is often used with the Transit for determining distances, fixing grades, and similar work.

It consists mainly of a screw attached to the expanded arm of the ordinary clamp of the telescope axis; the screw is accurately cut, and passing through a nut in one side of the arm, presses against a little stud, A, fixed to the inside surface of the right-hand standard. In the side of the arm opposite the screw is an enclosed spiral spring which presses against the side of the stud, thus securing a positive movement of the gradienter-screw.

Near the other end of the screw, and turning with it, is a wheel, or micrometer, the rim of which is covered with sterling silver, and divided into one hundred equal parts.

A small silver scale, attached to the arm and just above the micrometer wheel, is divided into spaces, each of which is just equal to one revolution of the screw; so that by comparing the edge of the wheel with the divisions of the scale, the number of complete revolutions of the screw can be easily counted.

When the clamp is made fast to the axis by the clamp-screw, and the gradienter-screw is turned, it will move the **MEASURING DISTANCES.** telescope vertically, like the tangent screw ordinarily used. And as the value of the screw thread is such that a complete revolution of the screw will move the horizontal cross-wire of the telescope over a space of one foot on a vertical rod at a distance of one hundred feet, it is clear that when the screw is turned through fifty spaces on the graduated head, the wire will pass over fifty hundredths, or one-half a foot on the rod, and so on in the same proportion. In this way the gradienter can be used in the measurement of distances.

To avoid any possibility of error, it is advisable that observations should not be taken by a reversal of the screw.

Grades can also be established with great facility, as follows: Level the instrument; bring the telescope level to the middle by the clamp and gradienter-screw; move the graduated head until its zero is brought to the edge of the scale; then turn off as many spaces on the head as there are hundredths of feet to the hundred in the grade to be established.

GRADES.

DETACHABLE TELESCOPES FOR VERTICAL SIGHTING.

A common arrangement for sighting up or down a vertical shaft is shown in No. 160, in which an extra telescope is fitted by a flange and disk connecting it with the axis, so as to make it precisely parallel to the main telescope; a counterpoise, as shown, is fitted to the other end, and both can be detached at pleasure, and placed in the Transit box when not in use.

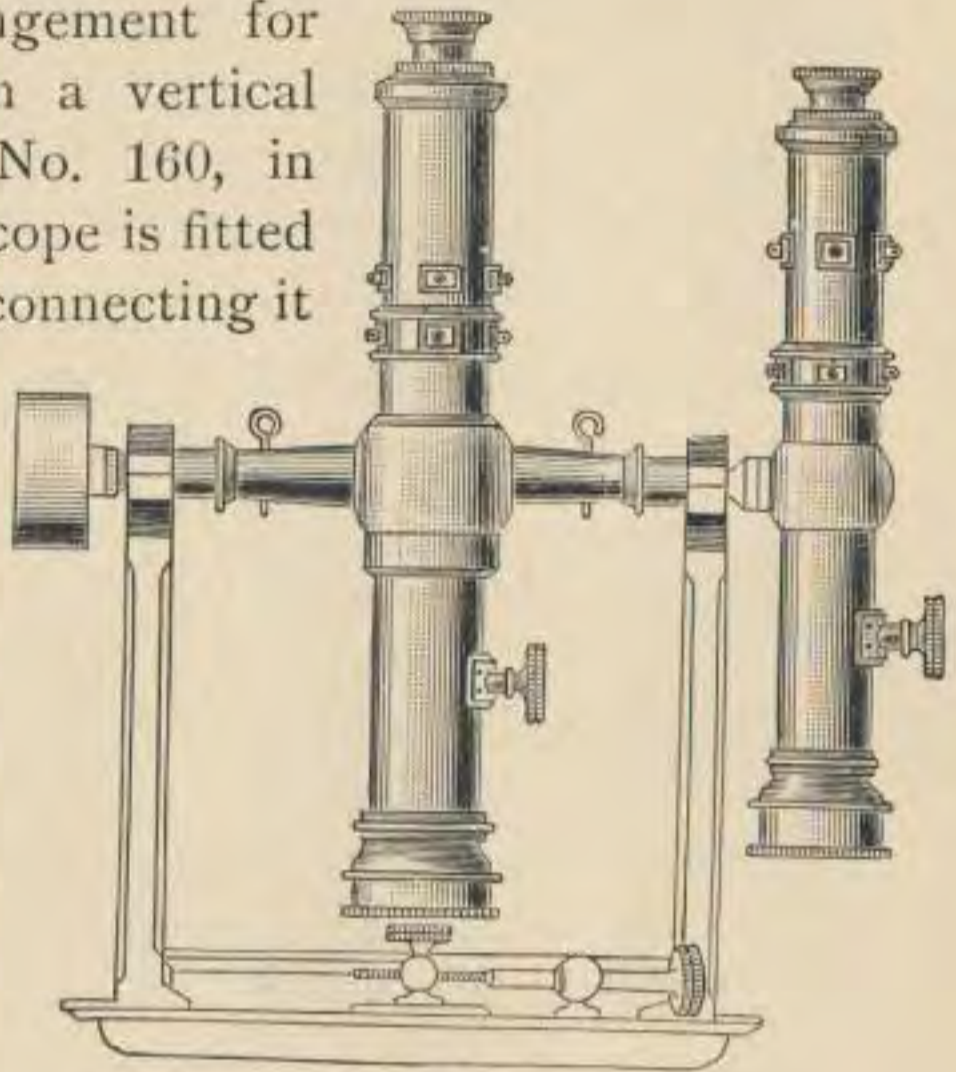

No. 160.

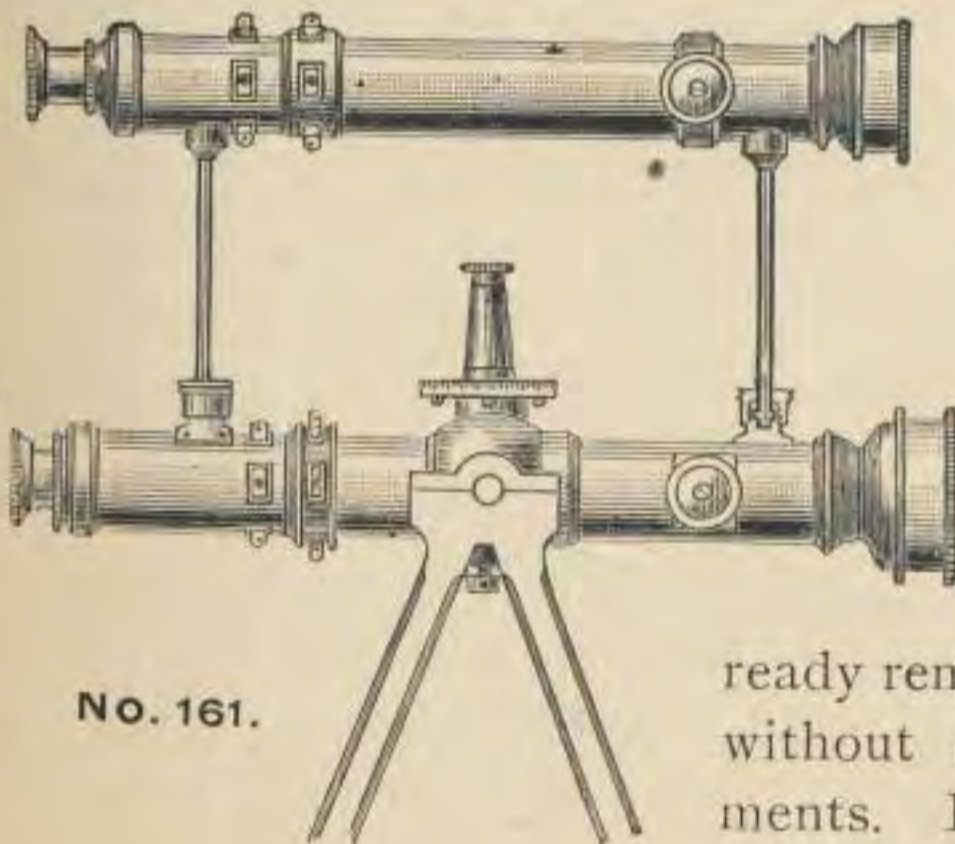

No. 161.

In No. 161, the extra telescope is connected with the main telescope by coupling-nuts, which fasten it securely directly over the center of the instrument and allow its

ready removal and replacement without disturbing its adjustments. It will be understood that in both arrangements the

extra telescope is adjusted to the main telescope of the Transit so that the lines of collimation of both are parallel and in the same plane, horizontal in No. 160 and vertical in No. 161; and in both the extra telescope swings over the outside of the Transit plates. The diagonal prism is often used with the extra telescope for greater convenience in sighting.

Price of either Telescope, No. 160 or 161.....\$25.00.



No. 165.
REFLECTOR.
PRICE, \$4.00.

The Reflector, No. 165, is an elliptical piece of silver, inclined at an angle of forty-five degrees with its ring, which is fitted to the object-glass end of the telescope. The hole in the reflector allows the use of the telescope, while a light held near the inner surface illuminates the cross-wires.

The Diagonal Prism, No. 168, is used when greater vertical angles are to be taken than are possible with the ordinary telescope. It consists of a prism attached to the cap of the eyepiece, by which the object is presented to the eye when placed at right angles with the telescope. When the telescope is directed to the sun the little slide or darkener containing colored glass is moved over the opening.

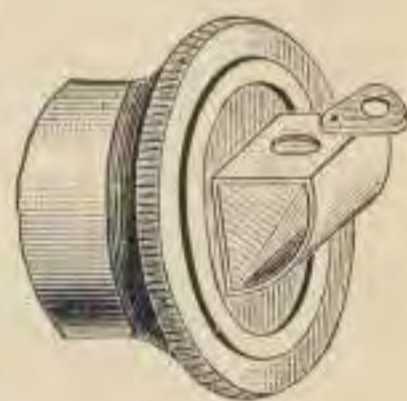

No. 168.
DIAGONAL PRISM.
PRICE, \$8.00.

The circular plate with which the prism is connected is made to turn in the cap, so that, when it is substituted for the ordinary cap of the eyepiece, the opening of the prism can be easily adjusted to the position of the eye. Observations can be taken with the prism up to an angle of sixty degrees elevation.

The Plummet-Lamp, No. 170, is a large plummet, of which the upper part is hollow to contain oil; it has also a tube for a wick, and an extinguisher.

It is hung in gimbals by a chain with hook, and so always assumes a vertical position, and when suspended from the shifting center of a leveling-head it can be easily adjusted over a given point.

Two of these lamps are often packed in a simple wooden case, furnished with a strap to sling over the shoulders. The weight of each lamp is about one and one-quarter pounds, and the price of each as shown is \$10.00.



No. 170

PLUMMET-LAMP.

QUICK-LEVELING ATTACHMENT.
(PATENTED.)

We have for several years made a quick-leveling attachment, the arrangement of which will be readily understood by inspection of the cut, No. 173, which shows the attachment screwed to a tripod.

In use, screw the instrument on the quick-leveling attachment previously fastened to the tripod; if not nearly level, unscrew the leveling-head a very little, — barely loosening the screw is sufficient. The instrument will then

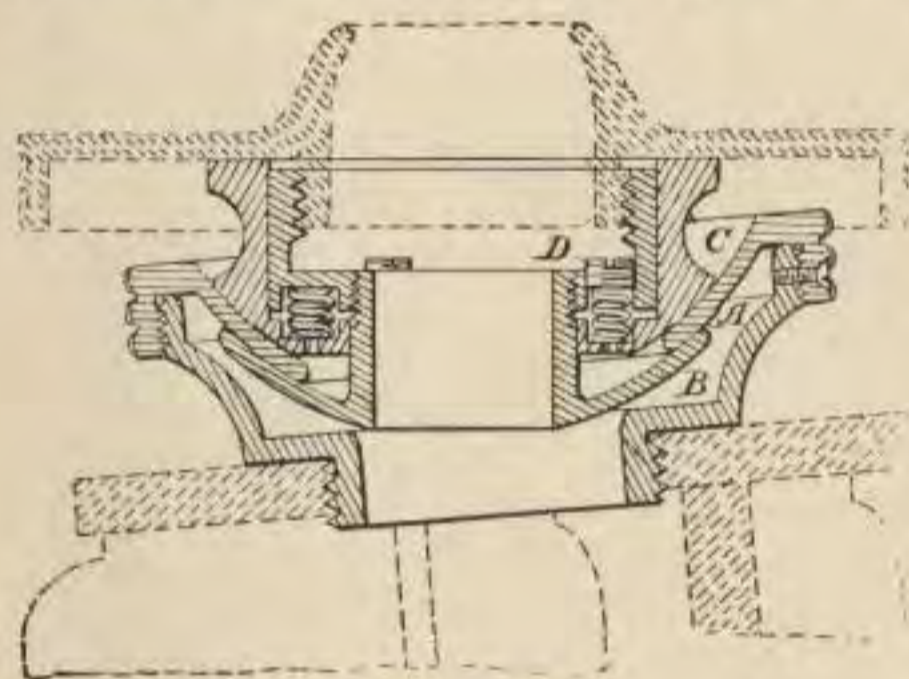

NO. 173.

any direction required to bring the plates approximately level, and will be held in this position by the friction of the surfaces. Now screw the head fast again, firmly clamping the whole instrument to the tripod. The final adjustment of the lev-

els is then completed by the use of the leveling-screws. The friction of the spherical surfaces may be increased or diminished at will, by turning the screws, D, which compress the spiral springs.

When ordered for any instrument already in use, the lower plate of the leveling-head, as shown in outline of the figure, or the head of the tripod should be sent to us by mail or express, prepaid, with a remittance of \$7.00 to pay for the attachment and return charges.

Price of the attachment when furnished with a new instrument, \$5.00; when adapted to an instrument already in use, \$6.00.

SOLAR ATTACHMENT.

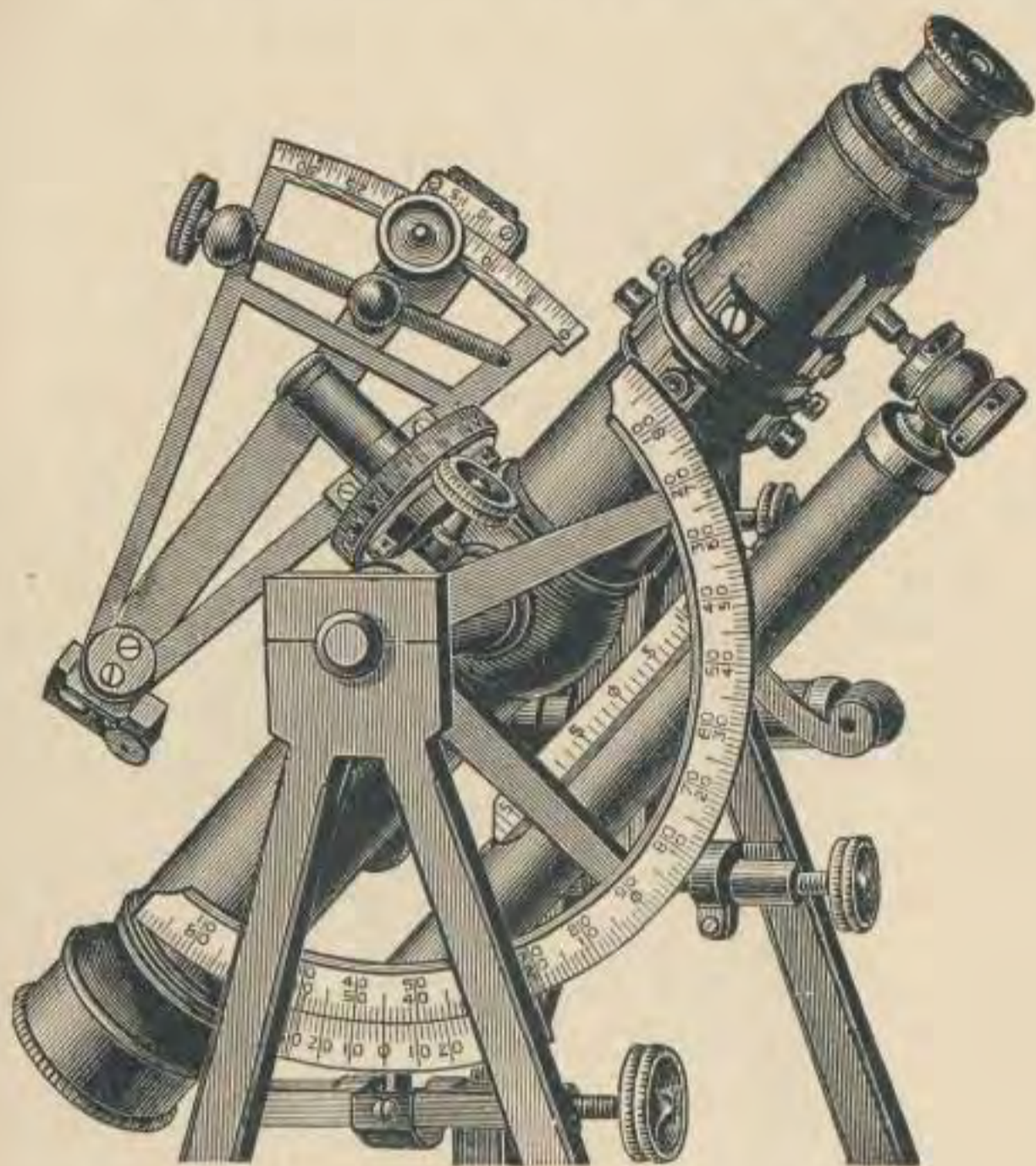

No. 190.

THE Solar Attachment is essentially the solar apparatus of Burt placed upon the cross-bar of the ordinary Transit, the polar axis being directed above instead of below, as in the Solar Compass. A little disk one and one-half inches in diameter, having a short round pivot projecting above its upper surface, is first securely screwed to the telescope axis. Upon this pivot rests the enlarged base of the polar axis, which is also firmly connected with the disk

by four capstan-head screws passing from the under side of the disk into the base already named. These screws serve to adjust the polar axis, as will be explained hereafter.

The Hour-Circle surrounding the base of the polar axis is easily movable about it, and can be fastened at any point desired by two flat head screws above. It is divided to five minutes of time, is figured from I to XII, and is read by a small index fixed to the declination arc and moving with it. A hollow cone, or socket, fitting closely to the polar axis and made to move snugly upon it, or clamped at any point desired by a milled head screw on top, furnishes by its arms below a firm support for the declination arc, which is securely fastened to it.

The Declination Arc has a radius of about five inches, and is divided to quarter degrees. On Mountain Transits it reads by its vernier to single minutes of arc, and on the larger Transits to half minutes of arc, the divisions of both vernier and limb being in the same plane. The declination arc has the usual lenses and silver plate on the two opposite blocks, also a clamp and tangent movement, as shown in the cut. The arc of the declination limb is turned on its axis and one or the other solar lens used, as the sun is north or south of the equator; the cut shows its position when the sun is north.

The Latitude is set off by means of a large vertical limb. The arc is figured from the center each way in two rows, from 0 to 80° and from 90° to 10°, the first series being intended for reading vertical angles and the latter series for setting off the latitude. The vernier of the vertical limb is made movable by the tangent screw attached, so that its zero and that of the

limb are readily made to coincide when, in adjusting the limb to the level of the telescope, the arc is clamped to the axis.

The usual tangent movement to the telescope axis serves to bring the vertical limb to the proper elevation, as hereafter described. A level on the under side of the telescope, with ground vial and scale, is indispensable in the use of the Solar Attachment. The arcs, verniers and hour-circle are all graduated on sterling silver. Price of the Solar Attachment, \$60.

EXPLANATION OF THE SOLAR ATTACHMENT.

In the engraving on page 64 we have a graphic illustration of the solar apparatus, the circles shown being intended to represent those supposed to be drawn upon the concave surface of the heavens.

When the telescope is set horizontal by its spirit-level, the hour-circle will be in the plane of the horizon, the polar axis will point to the zenith, and the zeros of the vertical arc and its vernier will coincide. Now, if we incline the telescope, directed north as shown in the cut, the polar axis will descend from the direction of the zenith. The angle through which it moves, being laid off on the vertical arc, will be the co-latitude of the place where the instrument is supposed to be used, the latitude itself being found by subtracting this number from ninety degrees.

When, however, the sun passes above or below the equator, his declination, or angular distance from it, as given in the Ephemeris, can be set off upon the arc, and his image brought into position as before.

In order to do this, however, it is necessary not only that the latitude and declination be correctly set off upon

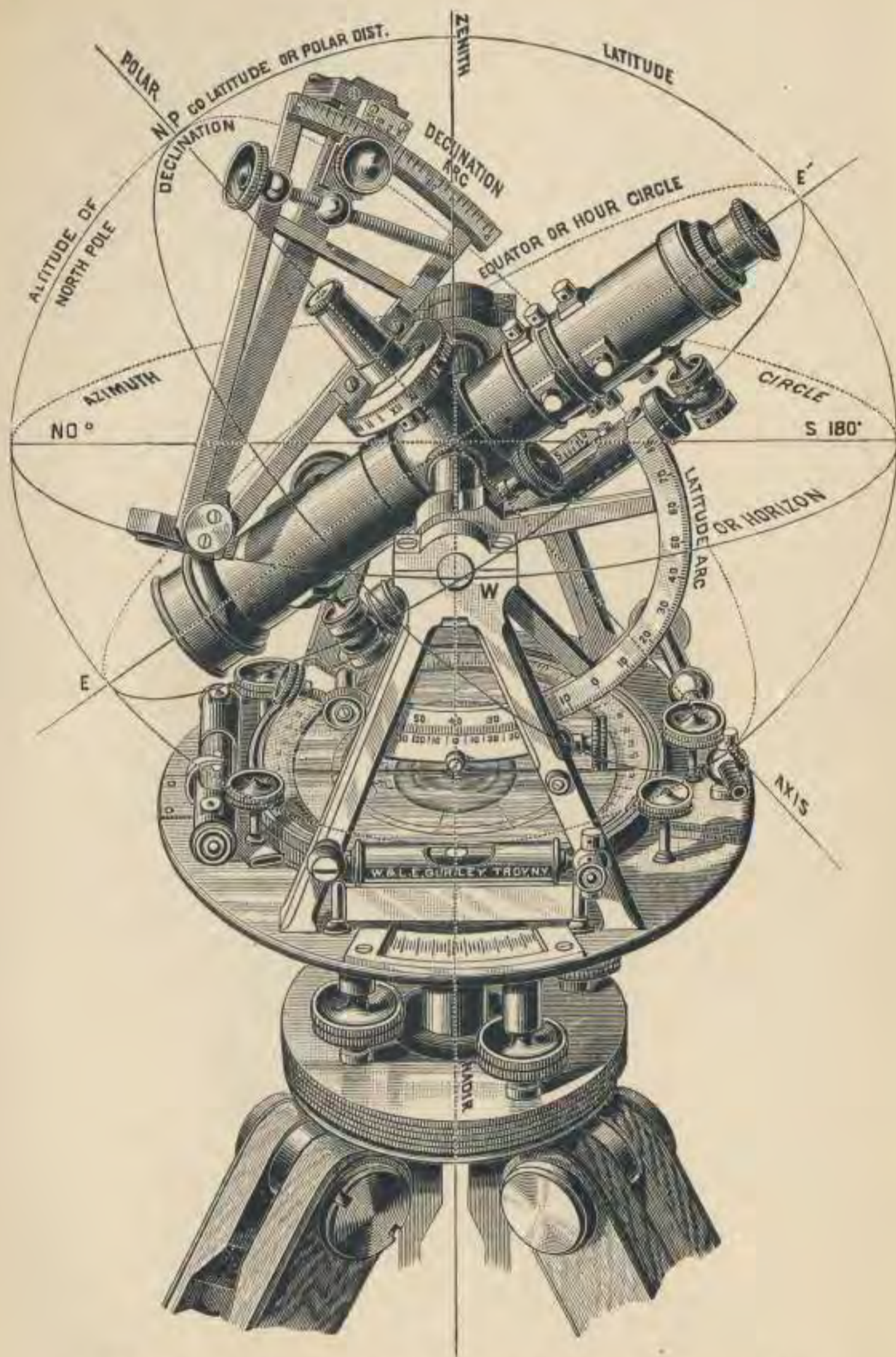

GRAPHIC ILLUSTRATION OF THE SOLAR APPARATUS

their respective arcs, but also that the instrument be moved in azimuth until the polar axis points to the pole of the heavens, or, in other words, is placed in the plane of the meridian; and thus the position of the sun's image will indicate not only the latitude of the place, the declination of the sun for the given hour and the apparent time, but it will also determine the meridian, or true north and south line passing through the place where the observation is made.



The interval between two equatorial lines, $c c$, as well as between the hour lines, $b b$, is just sufficient to include the circular image of the sun, as formed by

the solar lens on the opposite end of the revolving arm.

Allowance for Declination : - Let us now suppose the observation made when the sun has passed the equinoctial point, and when

DECLINATION. his position is affected by declination.

By referring to the Ephemeris, and setting off on the arc his declination for the given day and hour, we are still able to determine his position with the same certainty as if he remained on the equator.

When the sun's declination is south, that is, from the 22nd of September to the 20th of March in each year, the arc is turned downward, or *toward* the plates of the Transit, while during the remainder of the year the arc is turned *from* the plates.

When the Solar Attachment is accurately adjusted and its plates made perfectly horizontal, the latitude of the place and the declination of the sun for the given day and hour being also set off on their respective arcs, and the instrument set approximately north by the magnetic needle, *the image of the sun cannot be brought between the equatorial lines until the polar axis is placed in the plane of the meridian*

of the place, or in a position parallel with the axis of the earth. The slightest deviation from this position will cause the image to pass above or below the lines, and thus discover the error.

From the position of the sun in the solar system we thus obtain a direction absolutely unchangeable, from which to run lines and measure horizontal angles.

This simple principle is not only the basis of the construction of solar instruments, but it is the only cause of their superiority over instruments having the ordinary magnetic needle. For in an instrument having a magnetic needle, the accuracy of the horizontal angles indicated, and therefore of all the observations made, depends upon the delicacy of the needle and the constancy with which it assumes a certain direction, called the magnetic meridian.

The principal causes of error in the needle, briefly stated, are the dulling of the pivot and the resulting injury to the jeweled-center, the loss of polarity in the
ERROR jeweled-center, the loss of polarity in the
IN NEEDLE. needle, the influence of local attraction, and the effect of the sun's rays producing the diurnal variation. From all these imperfections the solar instrument is free.

The latitude of the place and the declination of the sun being set off upon the respective arcs, we are able not only to run the true meridian, or a due east and west course, but also to set off horizontal angles with minuteness and accuracy from a direction which never changes and which is unaffected by attraction of any kind.

ADVANTAGES OF THE SOLAR ATTACHMENT.

From what has been already said, the intelligent Surveyor will readily understand that the more perfect horizon obtained by the use of the telescope level, and the use of a

telescope in place of sights, render the new attachment more accurate than the ordinary Solar Compass.

The attachment can also be added to the telescope of any good Transit at a comparatively small cost, thus enabling the Surveyor to establish the true meridian, to determine the correct latitude, and to obtain true time very nearly.

Its adaptation to the purposes of illustration and instruction in practical astronomy in colleges and schools will occur to every teacher ; and it furnishes for the Government Surveyor a long-sought and much-needed instrument in many respects superior to the Solar Compass formerly used.

In experiments made by us, an error of one-quarter of a minute in the direction of the true meridian, or in latitude, could be easily detected by observing the sun's image by a magnifier ; and we feel confident that any one who uses the Solar Attachment will be surprised and delighted with its work. When not in use it should be removed from the telescope and packed in the instrument case, and the thin sheath put on the polar axis and kept in its place by the screw and washer of the socket.

The weight of the Solar Attachment is but little more than ten ounces, and is so distributed as not to disturb the counterpoise of the instrument, thus obviating the objection which has hitherto prevented the successful use of the telescope with the solar apparatus.

It is evident that all Transits to which the Solar Attachment is to be applied should have a horizontal limb and verniers, and should be furnished with a level on telescope, clamp and tangent to telescope axis, and vertical arc and vernier. They should also have a movable compass-circle to set off the variation of the needle, and be leveled by leveling-screws and parallel plates.

It will be understood that Transits of any kind which are to be fitted with the Solar Attachment must be in perfect order, especially in respect to the sockets, before correct work can be done.

TO RUN LINES WITH THE SOLAR ATTACHMENT.

Having set off the latitude of the place on the vertical arc, and the declination for the given day and hour as computed from the tables in the Solar Ephemeris, the instrument being also carefully leveled by the telescope bubble, set the horizontal limb at zero and clamp the plates, loosen the lower screw so that the Transit moves easily upon its lower socket, set the instrument approximately north and south, with the object-glass end of the telescope towards the north, turn the proper solar lens to the sun, and, with one hand on the plates and the other on the revolving arm, move them from side to side until the sun's image is brought between the equatorial lines on the silver plate.

The lower clamp of the instrument should now be fastened, and any further lateral movement be made by the tangent screw of the leveling-head. The necessary allowance being made for refraction, the telescope will be in the true meridian, and being unclamped may be used like the sights of the ordinary Solar Compass, but with far greater accuracy and satisfaction in establishing meridian lines. When the upper or vernier plate is unclamped from the limb, an angle read by the verniers is an angle from the meridian; and thus parallels of latitude or any other angles from the true meridian may be established as with the Solar Compass.

The bearing of the needle, when the telescope is on the meridian, will also give the variation of the needle at the point of observation.

If the instrument, as in our Surveyors' Transits, has a movable compass-circle, the variation of the needle can be set off to single minutes, the needle kept at zero, or "with the sun," and thus lines be run by the needle alone when the sun is obscured.

TO USE THE SOLAR.

Before this instrument can be used at any given place, it is necessary to set off upon its arcs both the declination of the sun as affected by its refraction for the given day and hour, and the latitude of the place where the observation is made.

The declination of the sun given in the Ephemeris, or **SETTING OFF** Nautical Almanac, from year to year, is **DECLINATION**. calculated for apparent noon at Greenwich, England.

To determine it for any other hour at a place in the United States, reference must be had, not only to the difference of time arising from the difference of longitude, but also to the change of declination during that time.

The longitude of the place, and therefore its difference in time, if not given directly in the tables of the Ephemeris, can be ascertained very nearly by reference to that of other places given which are situated on, or very nearly on, the same meridian.

It is the practice of Surveyors in states east of the Mississippi to allow a difference of six hours for the difference in longitude, calling the declination given in the Ephemeris for 12 M. that of 6 A. M. at the place of observation.

Beyond the meridian of Santa Fé, the allowance would be about seven hours; and in California, Oregon and Washington about eight hours.

Having thus the difference of time, we very readily obtain the declination for a certain hour in the morning, which would be earlier or later as the longitude was greater or less, and the same as that of apparent noon at Greenwich on the given day. Thus, suppose the observation made at a place five hours later than Greenwich, then the declination given in the Ephemeris for the given day at noon, affected by the refraction, would be the declination at the place of observation for 7 A. M. ; this gives us the starting-point.

To obtain the declination for the other hours of the day, take from the Ephemeris the declination for apparent noon of the given day, and, as the declination is increasing or decreasing, add to, or subtract from, the declination of the first hour the difference for one hour as given in the Ephemeris, which will give, when affected by the refraction, the declination for the succeeding hour; and proceed thus in making a table of declination for every hour of the day.

With a Transit having both horizontal and vertical limbs, direct observations of the sun may
DIRECT OBSERVATION. be taken; the image of the sun being observed through the darkener of the diagonal prism.

If desired, we will furnish, at a cost of \$5.00, a simple solar screen arranged to clamp to the eyepiece end of the
SOLAR SCREEN. telescope, and detachable at will. On this screen the image of the sun and cross-wires can readily be observed, a greater movement being given to the eyepiece of the telescope.

The formula used in reducing direct observations of the sun is $\text{sine}^2 \frac{1}{2} a = \frac{\text{sine } \frac{1}{2} (z + l - d) \cos. \frac{1}{2} (z + l + d)}{\text{sine } z \cos. l}$, in which $a =$
REDUCTION-FORMULA. sun's azimuth or bearing, $z =$ zenith distance or 90° altitude corrected for refraction, $d =$ declination of sun for time and place, $l =$ latitude of place.

EXAMPLE: At Troy, N. Y., March 31st, 1897, the sun's image was bisected by cross-wires and readings taken on both horizontal and vertical limbs. Three observations were taken obtaining an accurate average as follows: altitude $30^{\circ} 15'$, azimuth $145^{\circ} 30'$. Thus, $z = 90^{\circ} - (\text{altitude } 30^{\circ} 15' - \text{refraction } 1' 40'') = 59^{\circ} 46' 40''$; $l = 42^{\circ} 44'$; $d = 4^{\circ} 30' 30''$; $\frac{1}{2} (z + l - d) = 49^{\circ} 00'$; $\frac{1}{2} (z + l + d) = 53^{\circ} 35' 40''$. Solving these values we find $a = 114^{\circ} 29' 30''$. This added to azimuth $= 259^{\circ} 59' 30''$. Set the horizontal limb on this reading and the telescope will be in the meridian.

REFRACTION IN DECLINATION.

The Table of Refractions on pages 72-74 is calculated for latitudes between 15° and 60° at intervals of $2\frac{1}{2}^{\circ}$, that being as near as is required.

The declination ranges from 0° to 20° both north and south, the $+$ declinations being north and the $-$ south, and is given for every 5° , that being sufficiently near for all practical purposes. The hour angle in the first column indicates the distance of the sun from the meridian in hours, the refraction given for 0 hours being that which affects the observed declination of the sun when on the meridian, commonly known as meridional refraction; the refraction for the hour just before or after noon is so nearly that of the meridian that it may be called and allowed as the same.

When the table is used, it must be borne in mind that when the declination is north, or $+$ in the table, the refraction is to be added; when the declination is south, or $-$, the refraction must be subtracted. It will be noticed that the refraction in south, or $-$, declination increases very rapidly as the sun nears the horizon, showing that observations should not be taken with the sun when south of the equator, less than one hour from the horizon.

A TABLE OF MEAN REFRACTIONS IN
DECLINATION.

To apply on the declination arc of Solar Attachment of either Compasses or Transits.

Computed by EDWARD W. ARMS, C. E., for W. & L. E. GURLEY, Troy, N. Y.

HOUR ANGLE.	DECLINATIONS.									
	FOR LATITUDE 15°.									
	+20°	+15°	+10°	+5°	0°	-5°	-10°	-15°	-20°	
0 h.	-05''	0''	+05''	10''	15''	21''	27''	33''	40''	
2	-03	+02	07	12	18	23	29	36	43	
3	+01	05	11	16	22	28	34	41	49	
4	08	12	19	24	30	37	44	53	1'04	
5	29	34	41	49	59	1'10	1'24	1'43	2 08	
FOR LATITUDE 17° 30'.										
0 h.	-02''	+02''	08''	13''	18''	24''	30''	36''	44''	
2	0	05	10	15	21	27	33	40	48	
3	+02	10	15	21	27	33	40	48	57	
4	13	18	23	29	35	43	51	1'01	1'13	
5	34	41	49	58	1'10	1'23	1'41	2 06	2 42	
FOR LATITUDE 20°.										
0 h.	0''	05''	10''	15''	21''	27''	33''	40''	48''	
2	03	07	13	18	24	30	36	44	52	
3	06	13	18	24	30	36	44	52	1'02	
4	17	22	28	35	42	50	1'00	1'11	1 26	
5	39	47	57	1'07	1'20	1'37	2 00	2 32	3 25	
FOR LATITUDE 22° 30'.										
0 h.	02''	08''	13''	18''	24''	30''	36''	44''	52''	
2	06	11	15	21	27	33	40	48	57	
3	11	15	21	27	33	40	48	57	1'08	
4	20	26	32	39	46	56	1'07	1'19	1 37	
5	45	53	1'03	1'16	1'31	1'52	2 21	3 07	4 28	
FOR LATITUDE 25°.										
0 h.	05''	10''	15''	21''	27''	33''	40''	48''	57''	
2	08	14	19	25	31	38	46	54	1'05	
3	12	18	24	30	37	44	53	1'04	1 18	
4	23	29	35	45	53	1'03	1'16	1 31	1 52	
5	49	59	1'10	1'24	1'52	2 07	2 44	3 46	5 43	

HOUR ANGLE.	DECLINATIONS.								
	FOR LATITUDE 27° 30'.								
	+20°	+15°	+10°	+5°	0°	-5°	-10°	-15°	-20°
0 h.	08''	13''	18''	24''	30''	36''	44''	52''	1'02''
2	11	16	22	28	34	41	49	1'00	1 10
3	17	22	28	35	42	50	1'00	1 11	1 26
4	28	35	42	50	1'03	1'11	1 26	1 43	2 09
5	54	1'05	1'18	1'34	1 54	2 24	3 11	4 38	8 15
FOR LATITUDE 30°.									
0 h.	10''	15''	21''	27''	33''	40''	49''	57''	1'08''
2	14	19	25	31	38	46	54	1'05	1 18
3	20	26	32	39	47	55	1'06	1 19	1 36
4	32	39	46	52	1'06	1'19	1 35	1 57	2 29
5	1'00	1'10	1'24	1'52	2 07	2 44	3 46	5 43	13 06
FOR LATITUDE 32° 30'.									
0 h.	13''	18''	24''	30''	36''	44''	52''	1'02''	1'14''
2	17	22	28	35	42	50	1'00	1 11	1 26
3	23	29	35	43	51	1'01	1 13	1 28	1 47
4	35	43	51	1'01	1'13	1 27	1 46	2 13	2 54
5	1'03	1'15	1'31	1 53	2 20	3 05	4 25	7 36	
FOR LATITUDE 35°.									
0 h.	15''	21''	27''	33''	40''	48''	57''	1'08''	1'21''
2	20	25	32	38	46	55	1'05	1 18	1 35
3	26	33	39	47	56	1'07	1 21	1 38	2 00
4	39	47	56	1'07	1'20	1 36	1 59	2 32	3 25
5	1'07	1'20	1'38	2 00	2 34	3 29	5 14	10 16	
FOR LATITUDE 37° 30'.									
0 h.	18''	24''	30''	36''	44''	52''	1'02''	1'14''	1'29''
2	22	28	35	42	50	1'00	1 12	1 26	1 45
3	29	36	43	52	1'02	1 14	1 29	1 49	2 16
4	43	51	1'01	1'13	1 27	1 49	2 14	2 54	4 05
5	1'11	1'26	1 54	2 10	2 49	3 55	6 15	14 58	
FOR LATITUDE 40°.									
0 h.	21''	27''	33''	40''	48''	57''	1'08''	1'21''	1'39''
2	25	32	39	46	52	1'06	1 19	1 35	1 57
3	33	40	48	57	1'08	1 21	1 38	2 02	2 36
4	47	55	1'06	1'19	1 36	1 58	2 30	3 21	4 59
5	1'15	1'31	1 51	2 20	3 05	4 25	7 34	25 18	
FOR LATITUDE 42° 30'.									
0 h.	24''	30''	36''	44''	52''	1'02''	1'14''	1'29''	1'49''
2	28	35	39	50	1'00	1 12	1 26	1 45	2 11
3	36	43	52	1'02	1 13	1 29	1 49	2 17	2 59
4	50	1'00	1'11	1 26	1 44	2 10	2 49	3 55	6 16
5	1'16	1 36	1 58	2 30	3 22	5 00	9 24		

HOUR ANGLE	DECLINATIONS.								
	FOR LATITUDE 45°.								
	+20°	+15°	+10°	+5°	0°	-5°	-10°	-15°	-20°
0 h.	27''	33''	40''	48''	57''	1'08''	1'21''	1'39''	2'02''
2	32	39	46	52	1'06	1 19	1 35	1 57	2 29
3	40	47	56	1'07	1 21	1 38	2 00	2 34	3 29
4	54	1'04	1'16	1 33	1 54	2 24	3 11	4 38	8 15
5	1'23	1 41	2 05	2 41	3 40	5 40	12 02		
FOR LATITUDE 47° 30'.									
0 h.	30''	36''	44''	52''	1'02''	1'14''	1'29''	1'49''	2'18''
2	35	42	50	1'00	1 12	1 26	1 45	2 01	2 51
3	43	51	1'01	1 13	1 28	1 47	2 15	2 56	4 08
4	56	1'09	1 23	1 40	2 05	2 40	3 39	5 37	11 18
5	1'27	1 46	2 12	2 52	4 01	6 30	16 19		
FOR LATITUDE 50°.									
0 h.	33''	40''	48''	57''	1'08''	1'21''	1'39''	2'02''	2'36''
2	38	46	55	1'06	1 18	1 35	1 57	2 28	3 19
3	47	56	1'06	1 19	1 36	2 29	2 31	3 23	5 02
4	1'02	1'14	1 29	1 48	2 16	2 58	4 18	6 59	19 47
5	1 30	1 51	2 19	3 04	4 22	7 28	24 10		
FOR LATITUDE 52° 30'.									
0 h.	36''	44''	52''	1'02''	1'14''	1'29''	1'49''	2'18''	3'05''
2	43	50	59	1 11	1 26	1 42	2 23	2 49	3 55
3	50	1'00	1'11	1 26	1 45	2 11	2 51	2 58	6 22
4	1'05	1 18	1 35	2 10	2 28	3 19	4 53	8 42	
5	1 34	1 56	2 27	3 16	4 47	8 52			
FOR LATITUDE 55°.									
0 h.	40''	48''	57''	1'08''	1'21''	1'39''	2'02''	2'36''	3'33''
2	46	55	1'05	1 18	1 34	1 56	2 30	3 15	4 47
3	55	1'06	1 19	1 35	1 58	2 30	3 21	4 58	9 19
4	1'10	1 23	1 42	2 06	2 43	3 44	5 49	12 41	
5	1 37	2 01	2 34	3 28	5 15	10 18			
FOR LATITUDE 57° 30'.									
0 h.	44''	52''	1'02''	1'14''	1'29''	1'49''	2'18''	3'05''	4'37''
2	50	59	1 11	1 25	1 43	2 09	2 47	3 51	6 04
3	58	1'10	1 24	1 42	2 07	2 43	3 45	5 50	12 47
4	1'11	1 25	1 43	2 10	2 50	3 55	6 14	14 49	
5	1 41	2 06	2 42	3 42	5 46	12 26			
FOR LATITUDE 60°.									
0 h.	48''	57''	1'08''	1'21''	1'39''	2'02''	2'36''	3'33''	5'23''
2	54	1'04	1 17	1 33	1 54	2 24	3 12	4 38	8 15
3	1'03	1 15	1 30	1 51	2 20	3 04	4 24	7 31	24 44
4	1 18	1 34	1 56	2 28	3 18	4 50	8 53		
5	1 45	2 11	2 50	3 57	6 21	15 32			

TO COMPUTE THE DECLINATION.

Suppose it was required to obtain the declination for the different hours of April 16, 1895, at Troy, N. Y.

The longitude in time is four hours, fifty-four minutes and forty seconds, or practically five hours; so that the declination given in the Ephemeris for apparent noon of that day at Greenwich would be that of 7 A. M. at Troy.

Declination at Greenwich at noon of April 16, 1895.

N. $10^{\circ} 7' 56''.5$

N. $10^{\circ} 7' 56''.5$ + refr. 5 hrs. $1' 58'' = 10^{\circ} 9' 54'' =$ dec. 7 A. M. Troy
add hr. dif. $53''.2$

$10^{\circ} 8' 49''.7$ + " 4 " $1' 11'' = 10^{\circ} 10' 00'' =$ " 8 "
 $53''.2$

$10^{\circ} 9' 42''.9$ + " 3 " $52'' = 10^{\circ} 10' 34'' =$ " 9 "
 $53''.2$

$10^{\circ} 10' 36''.1$ + " 2 " $39'' = 10^{\circ} 11' 15'' =$ " 10 "
 $53''.2$

$10^{\circ} 11' 29''.3$ + " 1 " $36'' = 10^{\circ} 12' 05'' =$ " 11 "
 $53''.2$

$10^{\circ} 12' 22''.5$ + " 0 " $36'' = 10^{\circ} 12' 58'' =$ " 12 M.
 $53''.2$

$10^{\circ} 13' 15''.7$ + " 1 " $36'' = 10^{\circ} 13' 51'' =$ " 1 P. M.
 $53''.2$

$10^{\circ} 14' 08''.9$ + " 2 " $39'' = 10^{\circ} 14' 47'' =$ " 2 "
 $53''.2$

$10^{\circ} 15' 02''.1$ + " 3 " $52'' = 10^{\circ} 15' 54'' =$ " 3 "
 $53''.2$

$10^{\circ} 15' 55''.3$ + " 4 " $1' 11'' = 10^{\circ} 17' 06'' =$ " 4 "
 $53''.2$

$10^{\circ} 16' 48''.5$ + " 5 " $1' 58'' = 10^{\circ} 18' 46'' =$ " 5 "
 $53''.2$

Again, suppose it was desired to obtain the corrected declination for the different hours of October 16, 1895, at Troy, N. Y.

The difference in time being nearly five hours, and the declination at Greenwich, noon, $8^{\circ} 53' 53''.6$, that declination affected by the refraction would give the true declination for 7 A. M. at Troy; the latitude being nearly $42^{\circ} 30'$. The declination being now south, the refraction is to be subtracted, but the hourly difference is to be added because the declination is increasing, as in the first example; thus:

S. $8^{\circ} 53' 53''.6$ — refr. 5 hrs. $9' 24'' = 8^{\circ} 44' 30'' =$ dec. 7 A. M. Troy,
add hr. dif. $55''.3$

$8^{\circ} 54' 48''.9$ — “ 4 “ $2' 49'' = 8^{\circ} 52' 00'' =$ “ 8 “
 $55''.3$

$8^{\circ} 55' 44''.2$ — “ 3 “ $1' 49'' = 8^{\circ} 53' 55'' =$ “ 9 “
 $55''.3$

$8^{\circ} 56' 39''.5$ — “ 2 “ $1' 26'' = 8^{\circ} 55' 13'' =$ “ 10 “
 $55''.3$

$8^{\circ} 57' 34''.8$ — “ 1 “ $1' 14'' = 8^{\circ} 56' 21'' =$ “ 11 “
 $55''.3$

$8^{\circ} 58' 30''.1$ — “ 0 “ $1' 14'' = 8^{\circ} 57' 16'' =$ “ 12 M.
 $55''.3$

$8^{\circ} 59' 25''.4$ — “ 1 “ $1' 14'' = 8^{\circ} 58' 11'' =$ “ 1 P. M.
 $55''.3$

$9^{\circ} 00' 20''.7$ — “ 2 “ $1' 26'' = 8^{\circ} 58' 55'' =$ “ 2 “
 $55''.3$

$9^{\circ} 01' 16''.0$ — “ 3 “ $1' 49'' = 8^{\circ} 58' 27'' =$ “ 3 “
 $55''.3$

$9^{\circ} 02' 11''.3$ — “ 4 “ $2' 49'' = 8^{\circ} 59' 22'' =$ “ 4 “
 $55''.3$

$9^{\circ} 03' 06''.6$ — “ 5 “ $9' 24'' = 8^{\circ} 53' 43'' =$ “ 5 “

We believe it will be found that the use of the table as illustrated above will not only relieve the Surveyor of the

perplexity hitherto attending the subject of refractions, but will also enable him to secure more accurate results than were possible by the methods usually given.

The calculation of the declination for the different hours of the day should, of course, be made and noted before the Surveyor begins his work, that he may lay off the change from hour to hour, from a table prepared as above described.

TO FIND THE LATITUDE.

First, level the instrument very carefully, using, as before, the level of the telescope until the bubble will remain in the middle during a complete revolution of the instrument, the tangent movement of the telescope being used in connection with the leveling-screws of the parallel plates, and the axis of the telescope being firmly clamped.

Next, clamp the vertical arc, so that its zero and the zero of its vernier coincide as near as may be, and then bring them into exact line by the tangent screw of the vernier.

Then, having the declination of the sun for 12 o'clock of the given day as affected by the meridional refraction carefully set off upon the declination arc, note also the equation of time; and fifteen or twenty minutes before noon, the telescope being directed to the north and the object-glass end lowered until, by moving the instrument upon its spindle and the declination arc from side to side, the sun's image is brought nearly into position between the equatorial lines. Now bring the declination arc directly in line with the telescope, clamp the axis, and with the tangent screw of the telescope axis bring the image precisely between the lines and keep it there with the tangent screw, raising it as long

as it runs below the lower equatorial line, or, in other words, as long as the sun continues to rise in the heavens.

When the sun reaches the meridian the image will remain stationary in altitude for an instant, and will then begin to rise on the plate.

The moment the image ceases to run below is, of course, apparent noon, when the index of the hour arc should indicate XII., and the latitude be determined by the reading of the vertical arc.

The angle through which the polar axis has moved in the operation just described is measured from the zenith instead of the horizon as in the Solar Compass, so that the angle read on the vertical limb is the complement of the latitude.

ADVANTAGES OF THE SOLAR.

The latitude itself is readily found by subtracting this angle from 90° ; thus at Troy the reading of the limb being found as above directed to be $47^\circ 16'$, the latitude will be $90^\circ - 47^\circ 16' = 42^\circ 44'$. The latitude may also be read direct by referring to the inner row of figures on the arc, beginning with 90 in the middle and reading to 10 on either side.

TIME FOR USING THE SOLAR.

The Solar, like the ordinary instrument, can be used at all seasons of the year, the most favorable time being, of course, in the summer, when the declination is north and the days are long and more generally fair. It is best not to take the sun at morning and evening when it is within half an hour of the horizon, nor at noon, as we have before stated, for about the same interval before and after it passes the meridian.

ADVANTAGES OF THE SOLAR IN SURVEYING.

While the Solar is indispensable in the surveys of public lands, it also possesses important advantages over the magnetic needle Compass when used in the ordinary surveys of farms, and similar work. For not only can lines be run and angles be measured without regard to the diurnal variation or the effect of local attraction, but the bearings being taken from the true meridian will remain unchanged for all time.

In favorable weather surveys can be made more rapidly with it than with the ordinary needle-instrument; there being no time consumed in waiting for the needle to settle, or in avoiding the errors of local attraction.

When the sun is obscured the lines may be run by the needle alone, it being always kept with the sun, or at 0 on its arc, thus indicating the direction of the true meridian. The sun, however, must ever be regarded as the most reliable guide, and should, if possible, be taken at every station.

PATENT LATITUDE-LEVEL.

This attachment, shown in the cut on page 31, is used for recovering the latitude on a Solar Transit without referring to the vertical arc; and generally for setting the telescope at any desired angle in running grades and similar work.

It consists of a level connected by a short conical socket with the end of the telescope axis to which it is clamped by a milled head screw, and made adjustable by a tangent screw and spring on the enlarged end of the tube

When the clamp-screw is released the level turns vertically upon the axis, and can thus be set at any angle with the telescope, the final adjustment being made by the tangent screw.

The latitude being set off upon the vertical arc as usual, the level is clamped and brought into the middle as above described.

The telescope may then be released and used in running lines, until it is desired to recover the latitude again; this is easily and accurately done by the level alone without referring to the vertical arc.

Its use in running any desired grade is readily understood.

We make no additional charge for this attachment when furnished with a new solar instrument; when added to our old Solar Transits the cost will be \$6.00.

R. M. JONES' PATENT LATITUDE ARC.

In this attachment the usual vertical arc is omitted, and replaced by a double latitude arc attached to the under side of the telescope, as shown on page 81. The smaller arc having its center directly under the cross-bar of the telescope, has an arm with vernier reading the arc to single minutes, and carries also a level-tube open at both top and bottom, with a divided scale over each opening, in order to read the level accurately.

In obtaining latitudes with this attachment, the declination being set off as usual, the level-bubble should be brought into the middle of its scale when the sun is on the meridian.

The reading of the smaller arc then gives the latitude of the place, and in all further observations of the latitude

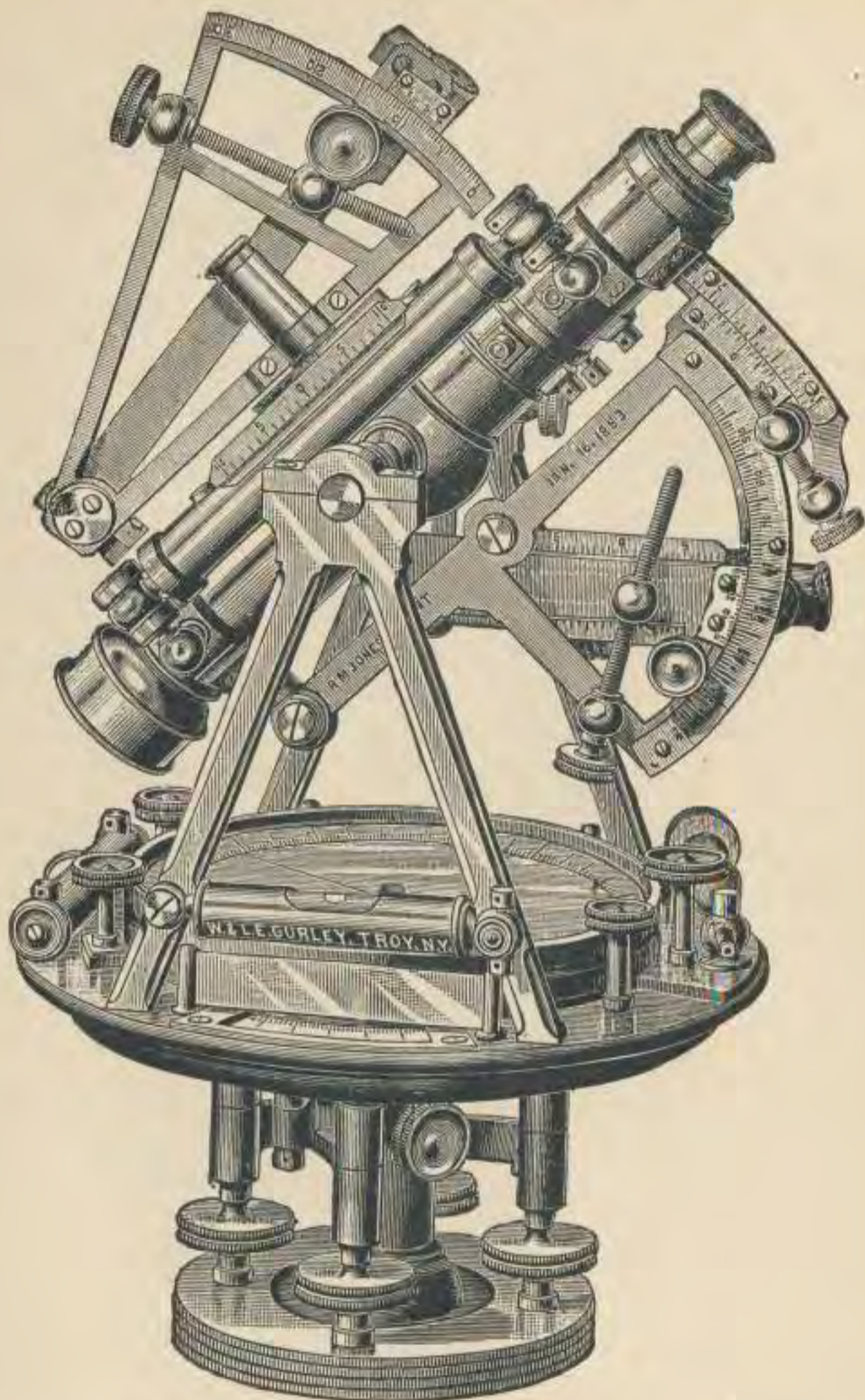

No. 31.

Light Mountain Solar Transit, with Jones' Patent Latitude Arc, and reversible level-bubble.

Price as shown, including extension tripod, \$300.00.

NOTE.— The standards, vernier openings and tangent movements are now made as shown on page 31.

reference is made to the level rather than to the divisions, the level being easily brought into the middle of the scale. This enables the Surveyor to recover the latitude more rapidly than with the ordinary vertical arc.

Minute changes, as long lines are run either north or south, may be computed and set off on the larger arc, which reads by its vernier to ten seconds of a degree.

The solar apparatus can also be used when the telescope is revolved and the apparatus brought below it, the latitude being now ascertained by reference to the other side of the level with its divided scale.

But one test of the adjustment of this attachment is required:—that both arcs should read zero when the telescope is made horizontal by its long level, and the smaller level of the arc below is also brought to the middle of its scale.

If not correct, they may be adjusted by loosening the screws by which each arc is confined, and moving the arcs until the zeros of both are in coincidence with the zeros of their verniers, care being taken to set the screws firmly again.

PRICES.

JONES' Patent Latitude Arc, with reversible level-bubble.....	\$ 73.00
When furnished with a new Transit of our make in place of the ordinary vertical arc, the JONES' Patent Latitude Arc, with reversible level-bubble, increases the cost of the instrument.....	55.00
Thus: The Light Mountain Transit, with Patent Solar Attachment and JONES' Patent Latitude Arc, costs.....	300.00

TO ADJUST THE SOLAR ATTACHMENT.

The declination arm is first detached by removing the **SOLAR LENSES** clamp and tangent screws and the center **AND LINES.** with its small screws, by which the arm is attached to the arc.

The adjuster, which is a short bar furnished with every instrument, is then substituted for the declination arm, the center screwed into its place at one end, and the clamp-screw into the other, being inserted through the hole left by the removal of the tangent screw, thus securing the adjuster firmly to the arc.

The declination arm is then placed on the adjuster, one end is turned to the sun, and brought into such a position that the image of the sun is brought precisely between the equatorial lines on the opposite plate.

Carefully turn the arm over, until it rests upon the adjuster by the opposite faces of the rectangular blocks, and again observe the sun's image. If it remains between the lines as before, the arm is in adjustment. If not, loosen the three small screws which hold it to the arm, and move the silver plate under their heads until one-half the error in the position of the sun's image is removed.

Bring the image again between the lines, and repeat the operation as above on both ends of the arm, until the image will remain between the lines of the plate in both positions of the arm, when it will be in proper adjustment, and the arm may be replaced in its former position on the attachment. This adjustment is very rarely needed in our instruments, the lenses being cemented in their cells and the plates securely fastened.

To adjust the Vernier of the Declination Arc: Set
DECLINATION the vernier at zero, and then raise or
ARC. lower the telescope until the sun's image
 appears exactly between the equatorial lines.

Having the telescope axis clamped, carefully revolve the arm until the image appears on the other plate. If precisely between the lines, the adjustment is complete;

if not, move the declination arm by its tangent screw until the image will come precisely between the lines on the two opposite plates; clamp the arm and remove the index error by loosening two screws that fasten the vernier; place the zeros of the vernier and limb in exact coincidence, tighten the screws, and the adjustment is complete.

To adjust the Polar Axis: First, level the instrument carefully by the long level of the telescope, using in the operation the tangent movement of the telescope axis in connection with the leveling-screws of the parallel plates, until the bubble will appear in the middle during a complete revolution of the instrument upon its axis.

Place the solar apparatus upon the axis and see that it moves easily around it; bring the declination arm in the



No. 196.

STRIDING OR ADJUSTING-LEVEL.

same vertical plane with the telescope, place the Adjusting-Level, No. 196, upon the top of the rectangular blocks, and bring the bubble of the level into the middle by the tangent screw of the declination arc.

Then turn the arc half-way around, bringing it again parallel with the telescope, and note the position of the level. If in the middle, the polar axis is vertical in that direction; if not in the middle, correct one-half of the error by the capstan-head adjusting-screws under the base of the

polar axis, moving each screw of the pair the same amount, but in an opposite direction. Bring the level to the middle again by the tangent screw of the declination arc, and repeat the operation as before, until the bubble will remain in the middle when the adjusting-level is reversed.

Pursue the same course in adjusting the arc in the second position, or over the telescope axis, and when completed the level will remain in the middle during an entire revolution of the arc, showing that the polar axis is at right angles with the level under the telescope, or truly vertical.

Care should be taken that the level under the telescope is kept in the middle, and the capstan-screws brought to a firm bearing.

The Adjusting-Level in the operation just described is supposed to be itself in adjustment; but if not, it can be easily corrected by the screw shown at one end, when reversed upon a plane surface, exactly as a mason's level is adjusted.

As this is by far the most delicate and important adjustment of the Solar Attachment, it should be made with the greatest care, the bubble kept perfectly in the middle and frequently inspected in the course of the adjustment.

To adjust the Hour-Arc: Whenever the instrument is set in the meridian, as will be hereafter described, the index of the hour-arc should read apparent time.

HOUR-ARC. If not, loosen the two flat head screws on the top of the hour-circle, and with the hand turn the circle around until it does, fasten the screws again, and the adjustment will be complete.

To obtain *mean time*, the correction of the equation for the given day, as found in the Nautical Almanac, should always be applied.

ASTRONOMICAL TERMS.

WE DEFINE, in the few pages following, the terms employed in the use and adjustment of the solar apparatus, as being of service to one not familiar with solar instruments.

SUN. The Sun is the center of the solar system, remaining constantly fixed in its position, although, for the sake of convenience, often spoken of as in motion around the earth.

EARTH. The Earth makes a complete revolution around the sun in three hundred and sixty-five days, five hours, forty-eight minutes and forty-six seconds.

It also rotates about an imaginary line passing through its center, and termed its axis, once in twenty-four hours, turning from west to east.

The Poles are the extremities of the axis; that in our own hemisphere, known as the north pole, if produced indefinitely toward the concave surface of the heavens, would reach a point situated near the polar star, and called the north pole of the heavens.

EQUATOR. The Equator is an imaginary line passing around the earth, equi-distant from the poles, and in a plane at right angles with the axis.

If the plane of the equator be produced to the heavens, it forms what is termed the equator of the heavens.

The Orbit of the earth is the path in which it moves in making its yearly revolution. If the plane of this orbit were produced to the heavens, it would form the ecliptic, or the sun's apparent path in the heavens.

The earth's axis is inclined to its orbit at an angle of about $23^{\circ} 27'$, making an angle between the earth's orbit and its equator, or between the celestial equator and the ecliptic, of the same amount.

EQUINOXES. The Equinoxes are the two points in which the ecliptic and the celestial equator intersect one another.

The Declination of the Sun is its angular distance north or south of the celestial equator; when the sun is at the equinoxes, that is, about the 21st of March and the 21st of September of each year, his declination is 0, or he is said to be on the equator; from these points his declination increases from day to day, and from hour to hour, until on the 21st of June and the 21st of December he is $23^{\circ} 27'$ distant from the equator.

It is the declination which causes the sun to appear so much higher in summer than in winter, his altitude in the heavens being in fact $46^{\circ} 54'$ more on the 21st of June than it is on the 21st of December.

The Horizon of a place is the surface which is defined by a plane supposed to pass through the place at right angles with a vertical line, and to bound our vision at the surface of the earth. The horizon, or a horizontal surface, is determined by the surface of any liquid when at rest, or by the spirit-levels of an instrument.

ZENITH. The Zenith of any place is the point directly overhead, in a line at right angles with the horizon.

MERIDIAN. The Meridian Circle of any place is a great circle passing through the zenith of a place and the poles of the earth.

The meridian, or true north and south line of any place, is the line determined by the intersection of the plane of the meridian circle with the plane of the horizon.

MERIDIAN ALTITUDE. The Meridian Altitude of the sun is its angular elevation above the horizon, when passing the meridian of a place.

LATITUDE. The Latitude of a place is its distance north or south of the equator, measured on a meridian. At the equator the latitude is 0° , at the poles 90° .

LONGITUDE. The Longitude of a place is its distance in degrees or in time, east or west of a given place taken as the starting-point or first meridian; it is measured on the equator or on any parallel of latitude.

In the Nautical Almanac, which is commonly used with a solar instrument, the longitude of the principal places in the United States is reckoned from Greenwich, England, and expressed both in degrees and hours.

ZENITH DISTANCE. The Zenith Distance of any heavenly body is its angular distance north or south of the zenith of a place, measured when the body is on the meridian.

Suppose a person to be on the equator at the time of an equinox; the sun, when on the meridian, would be in the zenith of the place, and the poles of the earth would lie in the plane of his horizon.

Disregarding, for the present, the declination of the sun, let us suppose that the person travels toward the north pole. As he passes to the north, the sun will descend from the zenith, and the pole will rise from the horizon in the same proportion, until when he arrives at the north pole of the earth the sun will have declined to the horizon, and the pole of the heavens will have reached the zenith.

The altitude of the pole at any place, or the distance of the sun from the zenith, would, in the case supposed, give the observer the latitude of that place.

If we now take into account the sun's declination, it will increase or diminish its meridian altitude, according as it passes north or south of the equator; but the declination of the sun at any time being known, its zenith distance, and therefore the latitude of the place, can be readily ascertained by an observation made when it is on the meridian. It is by this method that we obtain the latitude of any place by the Solar Compass.

A solar day is the interval of time between the departure of the sun from the meridian of a place, and its succeeding return to the same position. The **TIME.** length of the solar day, by reason of the inclination of the earth's axis, is constantly changing.

In order to have a uniform measure of time, we have **MEAN SOLAR DAY.** recourse to what is termed a *mean solar day*, the length of which is equal to the mean or average of all the solar days in a year.

The time thus given is called *mean time*, **MEAN TIME.** and is that to which clocks and watches are adjusted for local time.

EQUATION OF TIME. The sun is sometimes faster and sometimes slower than the clock, the difference being called the *equation of time*.

The moment when the sun is on the meridian of any place is called *apparent noon*, and this being ascertained, **APPARENT NOON.** we can, by adding the equation of time for the given day to, or subtracting from, apparent noon, according as the sun is slow or fast, obtain the time of *mean noon*, by which to set the watch or chronometer.

As the earth makes a complete rotation upon its axis once a day, every point on its surface must pass over three hundred and sixty degrees in twenty-four hours, or fifteen degrees in one hour, and so on in the same ratio. And as the rotation is from west to east, the sun would come to the meridian of every place fifteen degrees west of Greenwich just one hour later than the time given in the Ephemeris for apparent noon at that place.

To an observer situated at Troy, N. Y., the longitude of which is, in time, four hours, fifty-four minutes, forty seconds, the sun would come to the meridian nearly five hours later than at Greenwich, and thus when it was 12 M. at that place, it would be but about 7 A. M. in Troy.

By reason of the increasing density of the atmosphere from its upper regions to the earth's surface, the rays of light from the sun are bent out of their course, so as to make his altitude appear greater than is actually the case.

The amount of refraction varies according to the altitude of the body observed; being 0 when it is in the zenith, about one minute when midway from the zenith to the horizon, and almost thirty-four minutes when in the horizon.

There is a continual change of the place of the sun's image between the equatorial lines (which are the only transit lines to be regarded in surveying with the Solar), not only with the change of latitude, but also with the change of the sun's declination from hour to hour, marked by the motion of the revolving arm as it follows the sun in its daily revolution.

If the equatorial lines were always in the same vertical plane with the sun, as would be the case at the equator at

the time of the equinoxes, it is evident that refraction would have no effect upon the position of the image between these lines, and therefore would not be of any importance to the Surveyor.

But as we proceed farther north, and as the sun's declination to the south increases, the refraction also increases, and must now be taken into account.

Again, the angle which the equatorial lines make with the horizon is continually changing, as the arm is made to follow the motion of the sun during the course of a day.

Thus, in the morning and evening they are more or less inclined to the horizon, while at noon they are exactly parallel with it. And thus it follows that the excess of refraction at morning and evening is in some measure balanced by the fact that the position of the sun's image with reference to the equatorial lines is then less affected by it, on account of the greater inclination of the lines to the horizon.

The proper allowance to be made for refraction in setting off the declination is explained fully on pages 71-76

SURVEYORS' COMPASSES.

SOLAR COMPASS.

RAILROAD COMPASS.

VERNIER COMPASS.

PLAIN COMPASS.

ATTACHMENTS FOR COMPASSES.

COMPOUND BALL-SPINDLE.

LEVELING-ADOPTER.

LEVELING-HEAD.

TELESCOPIC SIGHT.

THE SOLAR COMPASS.

THIS instrument, so ingeniously contrived for readily determining a true meridian, or north and south line, was invented by WILLIAM A. BURT, of Michigan, and patented by him in 1836. It came into general use in the surveys of the U. S. public lands, the principal lines of which are required to be run with reference to the true meridian.

The invention long since became public property, and for nearly forty years the Solar Compass has been manufactured by us, with improvements of our own which have made it increasingly popular and efficient.

The arrangement of its sockets and plates is similar to that of the Surveyors' Transit as shown on page 34, except that the sight-vanes are attached to the under plate or limb, and this revolves around the upper or vernier plate on which the solar apparatus is placed.

The limb is graduated to half degrees, is figured in two rows as usual, and reads by the two opposite verniers to single minutes.

The graduations of the limb and all other arcs of the Solar Compass are made upon sterling silver.

THE SOLAR APPARATUS.

The solar apparatus is seen in the place of the needle, and in fact operates as its substitute in the field.

It consists mainly of three arcs of circles, by which can be set off the latitude of a place, the declination of the sun, and the hour of the day.

TO ADJUST THE SOLAR COMPASS.

The adjustments of this instrument with which the Surveyor will need to be familiar are simple and few in number, and will now be mentioned in order.

(1) To adjust the Levels: Proceed as directed in the account of the other instruments we have described, by bringing the bubbles into the middle of the tubes by the leveling-screws of the tripod, and then reversing the instrument upon its spindle and raising or lowering the ends of the tubes, until the bubbles will remain in the middle during a complete revolution of the instrument.

(2) To adjust the Equatorial Lines and Solar Lenses: Same as page 83.

(3) To adjust the Vernier of the Declination Arc: Same as page 83.

(4) To adjust the Solar Apparatus to the Compass-Sights: First level the instrument, and with the clamp and tangent screws set the main plate at ninety degrees by the verniers and horizontal limb. Then remove the clamp-screw, and raise the latitude arc until the polar axis is by estimation very nearly horizontal, and if necessary tighten the screws on the pivots of the arc, so as to retain it in this position.

Fix the vernier of the declination arc at zero, and direct the outside edges of the lens blocks to some distant and well-marked object, and observe the same through the compass sights. If the same object is seen by both observations, and the verniers read to ninety degrees on the limb, the adjustment is complete; if not, the correction must be made by moving the compass-sights or changing the position of the verniers.

It should be remarked that as the solar work is attached permanently to the sockets, and this adjustment made by

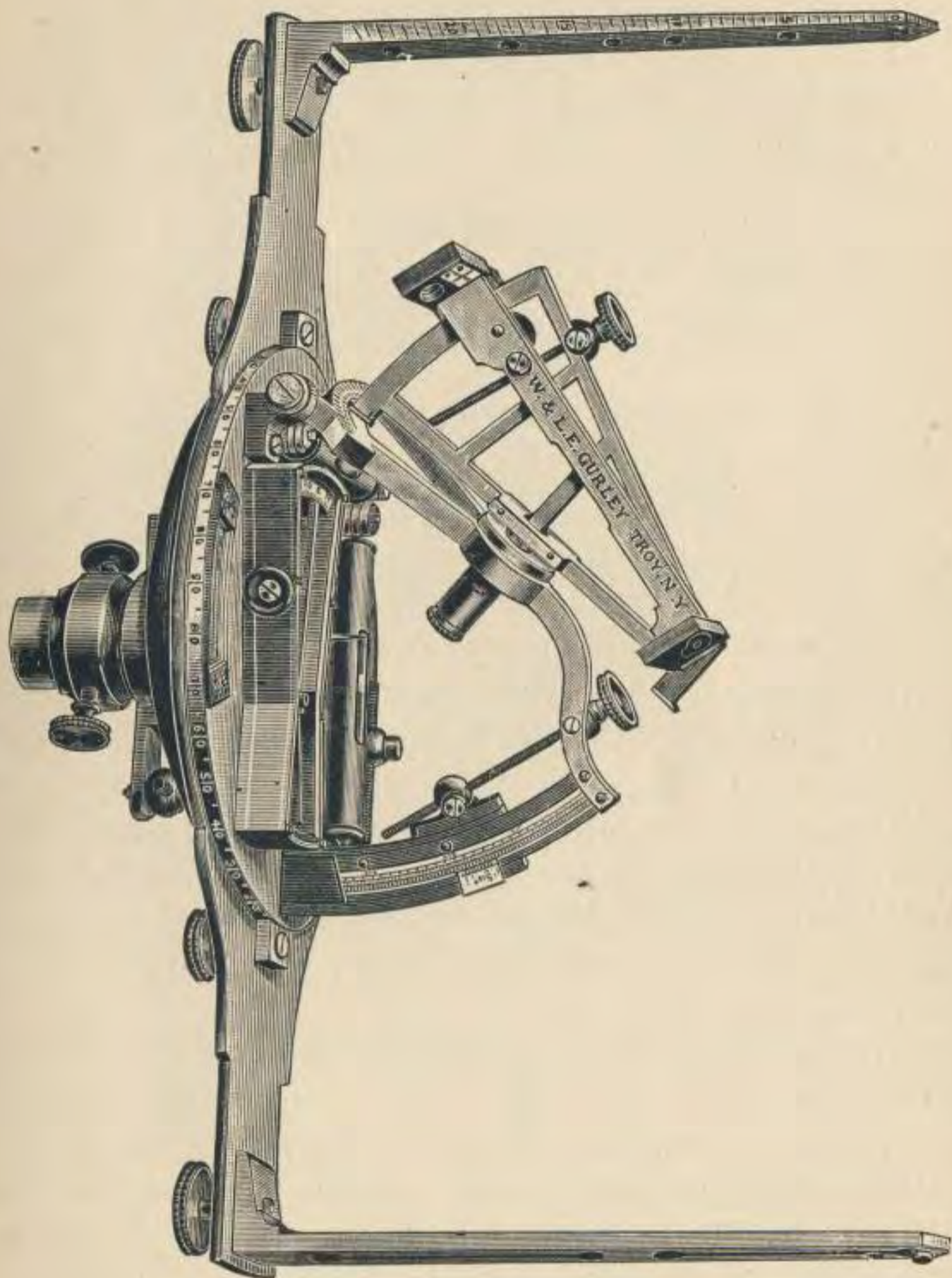

No. 210.

Price as shown, including leveling-screws and clamp and tangent to spindle, and with tripod, \$210.00.

the maker, it will need no further attention at the hands of the Surveyor except in case of serious accident.

The other adjustments are, of course, also made in the process of finishing the instrument, and are liable to very little derangement in the ordinary use of the Solar Compass.

This instrument should always be used on a **TRIPOD.** tripod, with screws for ready and accurate leveling, and a tangent screw for directing it to any desired point.

For this purpose a leveling-head with tangent screw, similar to those shown in the cut of the Surveyors' Transit, is furnished with every instrument.

TO RUN LINES WITH THE SOLAR COMPASS.

Having set off in the manner described the latitude and declination upon their respective arcs, the instrument being also in adjustment, the Surveyor is ready to run lines by the sun.

To do this, the instrument is set over the station and carefully leveled, the plates clamped at zero on the horizontal limb, and the sights directed north and south, the direction being approximately given, when unknown, by the needle.

The solar lens is then turned to the sun, and, with one hand on the instrument and the other on the revolving arm, both are moved from side to side, until **TRUE MERIDIAN.** the sun's image is made to appear on the silver plate. By carefully continuing this operation the image may be brought precisely between the equatorial lines. The line of sights will indicate the true meridian, and the observation may now be made and the flagman be put in position.

When a due east and west line is to be run, the verniers of the horizontal limb are set at ninety degrees, and the sun's image kept between the lines, as before.

The Solar Compass being so constructed that when the sun's image is in position the limb must be clamped at zero in order to run a true meridian line, it will be evident that the bearing of any line from the meridian may be read by the verniers of the limb precisely as in the ordinary magnetic needle Compass the bearing of lines is read from the ends of the needle.

In running lines the magnetic needle is always kept with the sun ; that is, the point of the needle is made to indicate zero on the arc of the compass-box, **USE OF THE NEEDLE.** by turning the tangent screw connected with its arm on the opposite side of the plate. By this means the lines can be run by the needle alone in case of the temporary disappearance of the sun ; but, of course, in such instances, the Surveyor must be sure that there is no local attraction. The variation of the needle, which is noted at every station, is read off in degrees and minutes on the arc, by the vernier on the arm of the needle-box.

In using the Compass, if the revolving arm be turned a little to one side of its proper position, a false or reflected image of the sun will appear on the silver plate in nearly the same place as that occupied by the true one. It is caused by the reflection of the true image from the surface of the arm, and is a fruitful source of error to the inexperienced Surveyor. It can, however, be readily distinguished from the real image by being much less bright, and not so clearly defined. **FALSE IMAGE.**

When the bearings of lines, such as the course of a stream or the boundaries of a forest, are not desired with

the certainty given by the verniers and the horizontal limb, a rough approximation of the angle which they make

APPROXIMATE BEARINGS. with the true meridian is obtained by the divisions on the outside of the circular plate. In this operation, a pencil or thin straight-edge of any kind is held perpendicularly against the circular edge of the plate, and moved around until it is in range with the eye, the brass center-pin, and the object observed. The bearing of the line is then read off at the point where the pencil is placed.

SUPERIORITY OF OUR SOLAR COMPASSES.

The Solar Compass as first made, though planned with great ingenuity in its general arrangement, was still extremely rude in its mechanical details and adjustments.

The points in which we claim the superiority of our Solar Compass over any other manufactured, and by means of which the defects just mentioned are entirely removed, are partially shown in the various cuts already given, and will now be stated in detail.

1. A motion of the horizontal plates entirely free from friction, combined with perfect rigidity.
2. A clamp and tangent movement to the divided limb, as shown under the plate.
3. A tangent movement with clamp to the declination arc.
4. A tangent movement with clamp to the latitude arc.
5. A tangent movement for the whole instrument about its socket.
6. Increased facility of adjustment, and therefore an important saving of time.

WEIGHT. The Solar Compass with leveling-head, but without tripod, weighs about fifteen pounds.

THE RAILROAD COMPASS.

THE ordinary Compass is used in surveys where great accuracy is not required, and where land is abundant and cheap. It is very difficult, however, to measure horizontal angles accurately and minutely by the needle alone; and in some localities, needle-instruments are considered so untrustworthy that Land Surveyors are forbidden to use an instrument unless it is capable of taking angles independently of the needle.

To meet the demand for more accurate work than can be done with the ordinary Compass, the Railroad Compass

PLATES AND LIMB. has been devised. This instrument is a Compass of the highest grade, with a graduated limb and verniers like those of the Transit. It has, as shown on page 100, the main plate, levels, sights and needle of the ordinary instrument, and in addition, underneath the main plate, a graduated circle or limb by which horizontal angles to single minutes can be taken independently of the needle.

The arrangement of the sockets is like that of the Surveyors' Transit with two verniers to limb,
SOCKETS. and the plates can be separated and replaced in the same manner.

The sockets upon which the plates of this instrument turn are long and well-fitted, and the movement of the vernier plate around the limb is almost entirely free from friction.

The verniers are attached to the under surface of the main plate at an angle of thirty degrees with
VERNIERS. the line of sights, the openings through which they are seen being covered with glass to protect the graduations from dust and moisture.

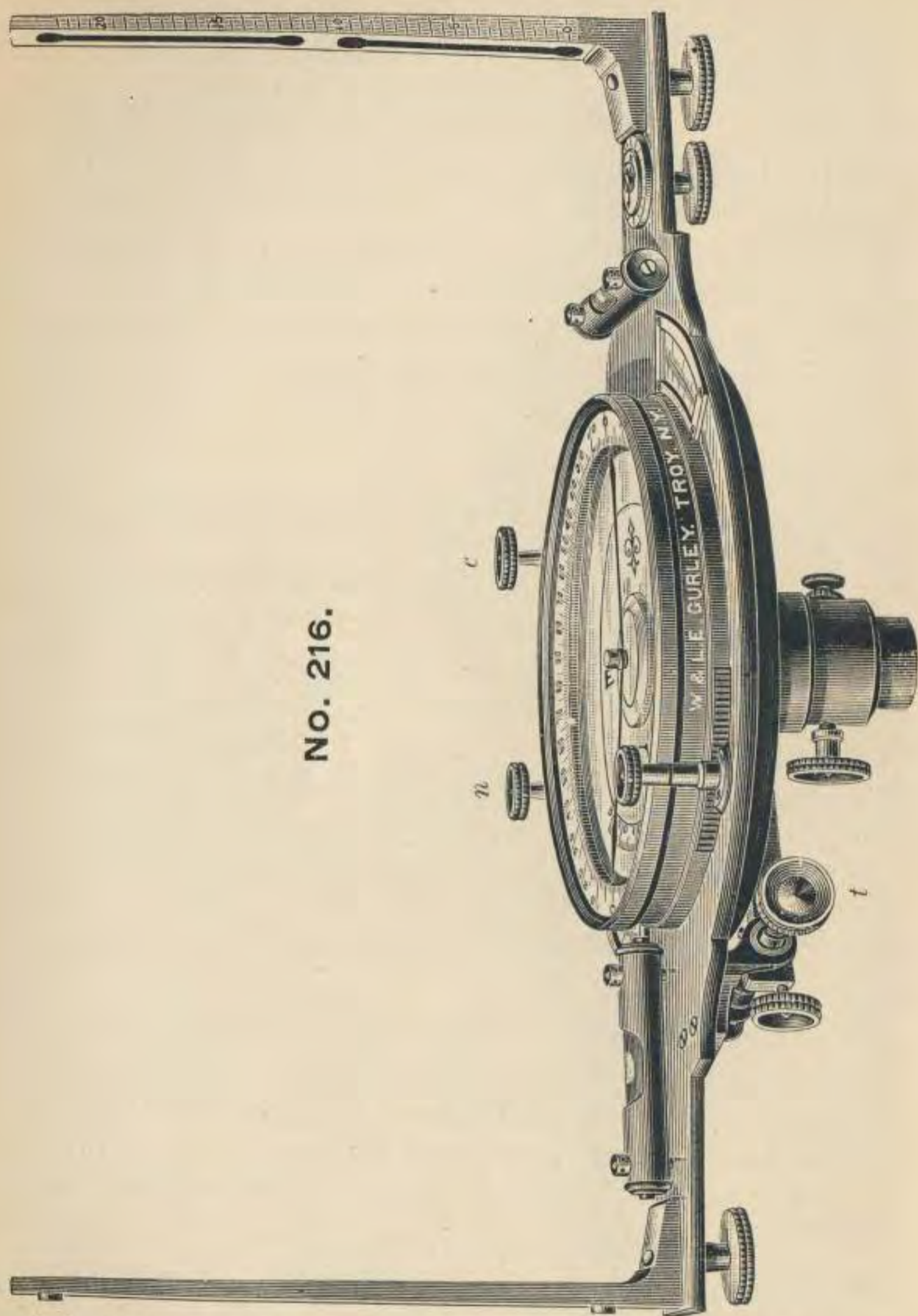

No. 216.

Railroad Compass, with two verniers to limb, $5\frac{1}{2}$ -inch needle and staff mountings.
Price, \$75.00.

The connection between the two plates is made by a clamp and tangent movement with opposing spring shown at *t*, by which they can be clamped together and released at will, or moved slowly around each other as may be desired in the use of the Compass.

The needle-lifting screw is shown at *n*, on the left of the plate. On the right of the Compass-circle is seen the head of a pinion working into a rack fixed to the edge of the compass-circle, thus enabling the Surveyor to move the compass-circle about its center in setting off the variation of the needle, as in the case of the Vernier Compass.

The variation is read to single minutes by a vernier and graduated arc, partially shown in the cut.

At *c* is shown a clamp-screw, by which the circle is securely fixed when moved to the proper position.

TO USE THE RAILROAD COMPASS.

It can be set upon the common ball-spindle, or still better, upon the tangent ball, placed either in a staff socket, a compass tripod, or the leveling-adopter and tripod as shown on page 118.

We have also adapted to many of these instruments the leveling tripod with a clamp and tangent movement, and this is preferable to any other support. (See page 119.)

To take Horizontal Angles: First level the plate and set the limb at zero, fix the sights upon one of the objects

HORIZONTAL selected, and clamping the whole instru-
ANGLES. ment to the spindle, unclamp the vernier plate and turn it with the hand until the sights are brought nearly upon the second object; then clamp to the limb, and with the tangent screw fix them precisely upon it.

The number of degrees and minutes read off by the vernier will give the angle between the two objects taken from the center of the instrument.

It will be understood that horizontal angles can be taken in any position of the verniers with reference to the zero point of the limb ; we have given that above as being the usual method, and liable to the fewest errors.

Where great accuracy is required, it is advisable, in this and other instruments which have two verniers, to obtain the readings of the limb from both, add the two together and halve their sum ; the result will be the mean of the two readings, and the true angle between the points observed.

Such a course is especially necessary when the readings of the verniers essentially disagree, as may sometime happen when the instrument has been injured by an accident.

In taking horizontal angles as just described, the magnetic bearings of the two objects are often noted, and thus **USE OF THE** two separate readings of the same angle, **NEEDLE.** one by the limb and the other by the needle, are obtained, to be used as checks upon each other to prevent mistakes.

To turn off the variation of the needle : Having leveled the instrument, set the limb at zero and place the **MAGNETIC** sights upon the old line, note the reading **VARIATION.** of the needle, and make it agree with that given in the field-notes of the former survey by turning the compass-circle about its center by the pinion-head.

Now clamp the compass-circle by the clamp-screw, and the number of degrees or minutes passed over by the vernier of the compass-circle will be the change of variation in the interval between the two surveys.

To survey with this instrument, the operator should turn the south end of the compass towards his person, **USING THE COMPASS.** and having brought the zeros of the limb and vernier plate in line, clamp them, and proceed as directed in our account of the Vernier Compass.

The Telescopic Sight, as hereafter described, is often used with the Railroad Compass with excellent results.

It will be understood that lines can be run and angles measured by the graduated limb and verniers, independently of the needle; and in places where local attraction is manifested this is very desirable.

The accuracy and minuteness of horizontal angles indicated by this instrument, together with its perfect adaptation to all the purposes for which the Vernier Compass can be used, have brought it into use in many localities where land is so valuable as to require more careful surveys than are practicable with a needle-instrument.

Size and Weight of the Railroad Compass with two Verniers: We make two sizes of this instrument, viz.: **SIZE AND WEIGHT.** with five and five and one-half-inch needles; the smaller size, including the brass head of the staff, weighs thirteen pounds, and the instrument with five and one-half-inch needle weighs about fourteen pounds.

RAILROAD COMPASS, ONE VERNIER TO LIMB.

This instrument is essentially like that already described, but of somewhat simpler construction in its sockets; and, though offered at a price materially lower than the other, it is in every way accurate and reliable.

Size and Weight of the Railroad Compass with one vernier: We make but one size of this instrument, with five and one-half-inch needle, which weighs about thirteen pounds.

THE VERNIER COMPASS.

THIS instrument, shown on page 106, has its compass-circle, to which is attached a vernier, movable about its center a short distance in either direction, enabling the Surveyor to set the zeros of the circle at any required angle with the line of sights. The number of degrees contained in this angle (or the variation of the needle), is read off by the vernier.

The Compass-Circle in this, as in all our instruments, is graduated to half degrees on its upper surface, the whole degree marks being also cut down on the inside circumference, and is figured from 0 to 90 on each side of the middle or line of zeros. The circle and face of the Compass are silvered. The movement of the circle is effected either by a tangent screw as shown in the cut, or by a concealed rack and pinion, the head of which projects from the under side of the main compass-plate. When the variation is set off as described, the circle is fastened in its position by a clamping nut underneath the main plate.

The Compass is usually fitted to a spindle made slightly conical, and having on its lower end a ball turned perfectly spherical, and confined in a socket by a pressure so light that the ball can be moved in any direction in leveling the Compass. The ball is placed either in the brass head of the staff, or, better, in the compass tripod seen in the cut of the Vernier Transit on page 47.

A leveling-adopter, shown on page 118, is also often used for more convenient leveling of the Compass.

The Staff Mountings consist of the brass head already mentioned, and a pointed steel shoe. The staff, to which the mountings should be securely fastened, is procured from any wheelwright, or selected by the Surveyor himself from a sapling of the forest.

STAFF MOUNTINGS.

The Spirit-Levels are placed at right angles with each other so as to level the plate in all directions, and are balanced upon a pivot under the middle of the tube, so as to be adjustable by a common screw-driver.

LEVELS.

The Sights, or sight-vanes, have fine slits cut through nearly their whole length, terminated at intervals by circular apertures, through which the object sighted upon is more readily found. Sometimes a fine horse-hair or wire is substituted for half the slit, and placed alternately with it on opposite sights.

SIGHTS.

The Telescopic Sight is often supplied with the Vernier Compass, and its adjustments and use are described on pages 120-126.

The right and left edges of the sights of our Compasses have respectively an eyepiece and a series of graduations, by which angles of elevation and depression, for a range of about twenty degrees each way, can be taken with considerable accuracy.

TANGENT SCALE.

This arrangement is very properly called a tangent scale, the graduated edges of the north sight being tangents to segments of circles having their centers at the eyepieces, and their points of contact with the tangent lines at the zero graduations of the scale.

The cut shows the eyepiece and graduations for angles of elevation; those for angles of depression, not shown in this cut, are seen in the cut of the Plain Compass.

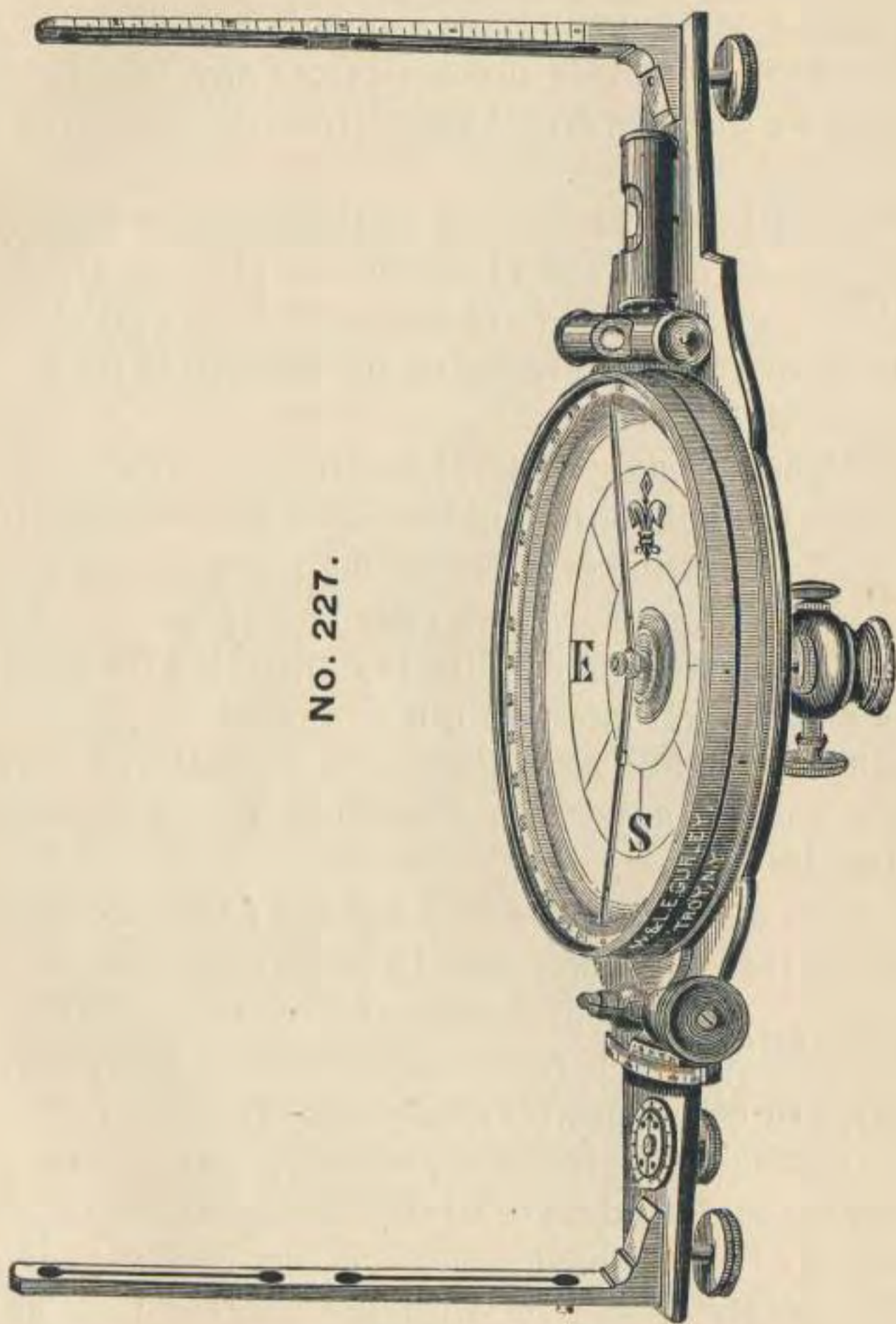

Vernier Compass, 6-inch needle, with staff mountings.
Price, \$40.00.

In the side of the hollow cylinder, or socket of the
CLAMP-SCREW. Compass, which fits to the ball-spindle,
 is a screw by which the instrument may
 be clamped to the spindle in any position.

Besides the clamp-screw, there is fitted to the sockets
SPRING-CATCH. of our Compasses a little spring-catch,
 which, as soon as the instrument is set
 upon its spindle, slips into a groove, and thus removes all
 danger of the instrument falling off the spindle while being
 carried.

There is underneath the main plate a needle-lifting screw
NEEDLE-LIFTER. which, by moving a concealed spring,
 raises the needle from the pivot and thus
 prevents the blunting of the point in transportation.

When the Compass is not in use, it is the practice of
 many Surveyors to let down the needle upon the point of
 the center-pin and let it assume its position in the magnetic
 meridian, so as to retain its polarity. We would advise
 that after the needle has settled it should be raised against
 the glass, in order not to dull the point of the center-pin.

A small dial-plate, having an index turned by a milled
OUTKEEPER. head underneath, is used with this and other
 Compasses to keep tally in chaining. The
 dial is figured from 0 to 16, the index being moved one
 notch for every chain run.

A brass cover is fitted over the glass of
BRASS COVER. the Compass, and serves to protect it from
 accident, as well as to prevent electric disturbance.

The superiority of the Vernier over the Plain Compass
USE OF THE VERNIER. consists in its adaptation to retracing the
 lines of an old survey, and to the surveys
 of the U. S. public lands, where the lines are based on a
 true meridian.

It is well known that the magnetic needle in almost all parts of the United States points more or less to the east **VARIATION OF** or west of a true meridian, or north and **THE NEEDLE.** south line. This deviation, which is called the *variation of the needle*, is not constant, but increases or decreases to a very sensible amount in a series of years.

Thus at Troy, N. Y., a line bearing in 1871, N. 31° W., would, in 1897, with the same needle, have a bearing of about N. $32^{\circ} 31'$ W., the needle having thus in that interval traveled nearly $1^{\circ} 31'$ to the west.

For this reason, in running over the lines of a farm from field-notes of some years' standing, the Surveyor is obliged to make an allowance, both perplexing and uncertain, in the bearing of every line. To avoid this difficulty the *vernier* was devised.

VERNIER. The Vernier is graduated on its edge into thirty equal parts, and figured in two series on each side of the middle line.

In the same plane with the vernier is an arc or limb, fixed to the main plate of the Compass, and graduated to half degrees.

Each graduation of the vernier is one minute shorter than a single graduation of the limb.

The surfaces of both vernier and limb are silvered.

In reading the vernier, if it is moved to the right, count the minutes from its zero point to the right and *vice versa*.

TO READ THE VERNIER. Proceed thus until a graduation on the vernier is found exactly in line with another on the limb, and the lower row of figures on the vernier will give the number of minutes passed over. When the vernier is moved more than fifteen minutes to either side, the number of additional minutes up to thirty,

or one-half degree of the limb, is given by the upper row of figures on the opposite side of the vernier.

To read beyond thirty, add the minutes given by the vernier to that number, and the sum will be the correct reading.

In all cases when the zero-point of the vernier passes a whole degree of the limb, this must be added to the minutes, in order to define the distance over which the vernier has been moved.

It will be seen that the Surveyor having the Vernier **TO SET OFF THE VARIATION.** Compass can, by moving the vernier to either side, and with it, of course, the compass-circle attached, set the Compass to any variation.

He therefore places his instrument on some well-defined line of the old survey, and turns the tangent screw until the needle of his Compass indicates the same bearing as that given in the field-notes of the original survey.

Then, clamping the vernier, he can run all the other lines from the old field-notes without further alteration.

The reading of the vernier on the limb in such a case would show the change of variation of the two different periods.

The variation of the needle at any place being known, a true meridian, or north and south line, may be run by moving the vernier to either side, as the variation is east or west, until the arc passed over on the limb is equal to the angle of variation, and then turning the Compass until the needle is made to cut the zeros on the graduated circle. The line of sights will then give the direction of the true meridian of the place.

Such a change in the position of the vernier is necessary in surveying the U. S. public lands, which surveys are always run from the true meridian.

The line of no declination, or variation, as it is called, or the line upon which the needle will indicate a true north and south direction, is situated in the United States nearly in an imaginary line drawn from Sault Ste. Marie, Michigan, to Charleston, South Carolina. A compass-needle, therefore, placed east of this line, has a variation to the west, and when placed west of the line the variation is to the east; and in both cases it increases as the needle is carried farther from the line of no variation.

Thus, in Minnesota, the variation is from eight to eleven degrees to the east, while in Maine it is from fifteen to nineteen degrees to the west. At Troy, in the present year, 1897, the variation is about $10^{\circ} 57'$ to the west, and is increasing in the same direction about three and one-half minutes annually.

The variation of the magnetic needle does not remain constant through an entire day; but it reaches its farthest point east about 8 o'clock, A. M., and its farthest point west about 2 o'clock, P. M. The cause of this daily variation of the needle is not understood, as observations show that it is greater in summer than in winter.

Conditions of temperature, magnetic storms and other causes at times affect the needle. Our own experiments show that different needles observed at the same time and under the same conditions differ in their direction, but show nearly the same daily change.

A less important use of the vernier is to give a reading of the needle to single minutes, which is obtained as follows:

First be sure, as in all observations, that the zero of the vernier exactly corresponds with that of the limb; then, noting the number of the whole degrees given by the needle, move back the compass-circle with the tangent screw until the nearest whole degree mark is made to coincide with the point of the needle, read the vernier as before described, and this reading added to the whole degrees will give the bearing to minutes.

TO READ TO MINUTES.

TO ADJUST THE COMPASS.

To adjust the Levels: First bring the level-bubbles into the middle by the pressure of the hand on different parts of the plate, and then turn the Compass half-way around; should the bubbles run to the end of the tubes, it would indicate that those ends were the highest; lower them by loosening the screws under the lowest ends and tightening those under the highest ends until, by estimation, the error is half removed; level the plate again, and repeat the first operation until the bubbles will remain in the middle during an entire revolution of the Compass.

THE LEVELS.

The sights may next be tested by observing through the slits a fine hair or thread, made exactly vertical by a plummet. Should the hair appear on the side of the slit, the sight must be adjusted by filing its under surface on the side which seems the highest.

SIGHT-VANES.

To adjust the Needle: Having the eye nearly in the same plane with the graduated rim of the compass-circle, with a small splinter of wood or a slender iron wire bring one end of the needle in

NEEDLE.

line with any prominent graduation of the circle, as the zero or the ninety degree mark, and notice if the other end corresponds with the degree on the opposite side; if it does the needle is said to "cut" opposite degrees; if not, bend the center-pin by applying a small brass wrench, furnished with our Compasses, about one-eighth of an inch below the point of the pin, until the ends of the needle are brought into line with the opposite degrees.

Then, holding the needle in the same position, turn the Compass half-way around, and note whether it now cuts opposite degrees; if not, correct half the error by bending the needle, and the remainder by bending the center-pin. The operation should be repeated until perfect reversion is secured in the first position.

This being obtained, it may be tried on another quarter of the circle; if any error is there manifested, the correction must be made in the center-pin only, the needle being already straightened by the previous operation.

When again made to cut, it should be tried on the other quarters of the circle, and corrections made in the same manner until the error is entirely removed, and the needle will reverse in every point of the graduated surface.

TO USE THE COMPASS.

In using the Compass, the Surveyor should keep the south end towards his person, and read the bearings from the north end of the needle. He will observe that the E and W letters on the face of the Compass are reversed from their natural position, in order that the direction of the line of sight may be correctly read.

The compass-circle being graduated to half degrees, a little practice will enable the Surveyor to read the bearings

to quarter degrees or even less, estimating with his eye the space bisected by the point of the needle ; and as this is as close as the traverse table is usually calculated, it is the general practice.

Sometimes a small vernier is placed upon the south end of the needle, and reads the circle to five minutes of a degree, the circle being in this case graduated to whole degrees.

This contrivance, however, is quite objectionable on account of the additional weight imposed upon the center-pin, and the difficulty of reading a vernier which is in constant vibration ; it is therefore but little used.

Having first leveled the Compass, bring the south end towards the person, and place the eye at the little button, **ANGLES OF ELEVATION.** or eyepiece, on the right side of the south sight, and with the hand fix a card on the front surface of the north sight, so that its top edge will be at right angles with the graduated edge and coincide with the zero mark. Then, sighting over the top of the card, note upon a flagstaff the height cut by the line of sight, move the staff up the elevation, and carry the card along the sight until the line of sight again cuts the same height on the staff ; read off the degrees and half degrees passed over by the card, and this will be the angle required.

ANGLES OF DEPRESSION. Proceed in the same manner, using the eyepiece and graduations on the opposite side of the sight, and reading from the top of the sight.

NEW AND OLD SURVEYS. When the Compass is to be used in making new surveys, the vernier should be set at zero and clamped by the nut beneath the plate.

In surveying old lines, the change of variation of the needle should be ascertained by setting the Compass on some well-defined line of the tract, and making the bearing

to agree with that of the old survey, by moving the circle as already described.

Then the circle can be clamped, and the old lines retraced from the bearings given by the original Surveyor.

When the variation of the needle is known, it can be set off by the vernier, and the Compass used to run a true meridian by the needle.

A little caution is necessary in handling the Compass, that the glass covering does not become charged with electricity excited by the friction of cloth, silk or the hand, so as to attract the needle to its under surface. When, however, the glass becomes so charged, the electricity may be removed by breathing upon it, or by touching different parts of its surface with the moistened finger. Ignorance of this apparently trifling matter has caused many errors and perplexities in the practice of the inexperienced Surveyor.

REPAIRS OF THE COMPASS.

To enable the Surveyor to make such repairs as are possible without having recourse to an instrument-maker, we here add a few simple directions.

NEEDLE. It may sometimes happen that the needle has lost its polarity and needs to be remagnetized; to do this, proceed as follows: Unscrew the bezel-ring that holds the glass face, remove the needle and pass with a gentle pressure each end of the needle from middle to extremity over the magnetic pole of an ordinary permanent magnet, describing before each pass a circle of about six inches radius, to which the surface of the pole is tangent, drawing the needle towards him, and taking care that the north and the south ends are applied to the *opposite* poles of the magnet.

Should the needle be returned in a path near the magnetic pole, the current induced by the contact of the needle and magnet, in the pass just described, would be reversed, and thus the magnetic virtue almost entirely neutralized at each operation.

When the needle has been passed about twenty-five times in succession in the manner just described, it may be considered as fully charged.

A fine brass wire is wound in two or three coils on the south end of the needle, and may be moved back or forth in order to counterpoise the varying weight of the north end.

The center-pin should occasionally be examined, and if much dulled should be taken out with the brass wrench or with a pair of pliers, and sharpened on a
CENTER-PIN. hard oilstone, the operator placing it in the end of a small stem of wood, or a pin-vise, and delicately twirling it with the fingers as he moves it back and forth at an angle of about thirty degrees with the surface of the stone.

When the point is thus made so fine and sharp as to be invisible to the eye, it should be smoothed by rubbing it on the surface of a soft and clean piece of leather.

To put in a new glass: Unscrew the bezel-ring which holds it, and with the point of a knife-blade spring out the little brass ring above the glass and
GLASS CIRCLE. remove the old glass and scrape out the putty. Then, if the new glass does not fit, smooth off its edges by holding it obliquely on the surface of a grindstone until it will enter the ring easily; then put in new putty, spring in the brass ring, and the operation will be complete.

To replace a level-vial: Take out the screws which hold it to the plate, pull off the brass ends of
LEVEL-VIAL. the tube, and with a knife-blade scrape out the plaster from the tube. Then with a stick made a little

smaller than the diameter of the tube, and with its end hollowed out so that it will bear only on the broad surface of the level-vial, push out the old vial and replace it with a new one, taking care that the crowning side, which has a file-mark on the end of the vial, is placed on the upper side.

When the vial does not fit the tube, it must be wedged up by putting little slips of paper under it, until it moves in snugly.

After the vial is in its place, put around its ends a little plaster of Paris mixed with water to the consistency of putty, taking care not to allow any to cover the little tip of the glass, then slip in the brass ends, and the operation will be complete.

A little beeswax, melted and dropped upon the ends of the vial, is equally as good as the plaster of Paris, and often more easily obtained.

An extra glass and level-vials are always furnished, free of charge, with every new Compass.

We make three sizes of the Vernier Compass, having needles respectively four, five and six inches long, the main plates being respectively twelve and one-half, fifteen and fifteen and one-half inches long. The sights of the smallest are also about an inch shorter than the others.

SIZES.

In the four and five-inch Vernier Compasses, the variation arc is within the compass-circle, like that of the Railroad Compass before described, and the variation is set off to minutes by a pinion-head underneath the plate, and this arc is clamped by a screw placed opposite the pinion.

The average weights of the different sizes, including the brass head of the staff, beginning with the smallest, are respectively six and one-quarter, eight and three-quarters and ten and one-half pounds.

WEIGHTS.

THE PLAIN COMPASS.

No. 232.



Price, with 6-inch needle and staff mountings, \$35.00.

THE Plain Compass shown in the cut has a six-inch needle, and is furnished with levels, sight-vanes, socket, etc.

The compass-box is in the same piece with the main plate, and the instrument is used chiefly in the surveys of new lines, or in the preparation of maps, where the variation of the needle is not required.

The adjustments and use of the Plain Compass are substantially the same as those of the Vernier Compass just described.

Three sizes of this instrument are in common use, having respectively four, five and six-inch needles, and differing also in the length of the main plate, which, in the four-inch Compass, is twelve and one-half

SIZES.

inches long, and in the larger sizes fifteen and fifteen and one-half inches.

The average weights of the different sizes, **WEIGHT.** with the brass mountings of the staff, are as follows :

Plain Compass with 4-inch needle.....	6	lbs.
“ “ “ 5-inch “	7 $\frac{3}{4}$	lbs.
“ “ “ 6-inch “ *	9 $\frac{1}{2}$	lbs.

We manufacture what is called a compound ball-spindle, which has a tangent movement, and **COMPOUND BALL-SPINDLE.** which gives all the perfection of more costly arrangements at a very moderate expense. The price is \$7.00.

As represented in the cut, No. 240, it has an interior spindle, around which an outside hollow cylinder is moved by turning the double-headed tangent screw, which has in

the middle a screw, working into teeth cut spirally around the cylinder. The Compass or other instrument revolves on the outside socket, exactly as if placed on a common ball-spindle ; but when a slower movement is desired, it can be clamped and then turned gradually around the interior spindle by the tangent screw, until the slot of the sight or the intersection of the wires is made to bisect the object with the utmost accuracy.

For more convenient leveling **LEVELING-ADOPTER.** of the Compass, as well as other instruments, we make the appliance

No. 240.

No. 241.

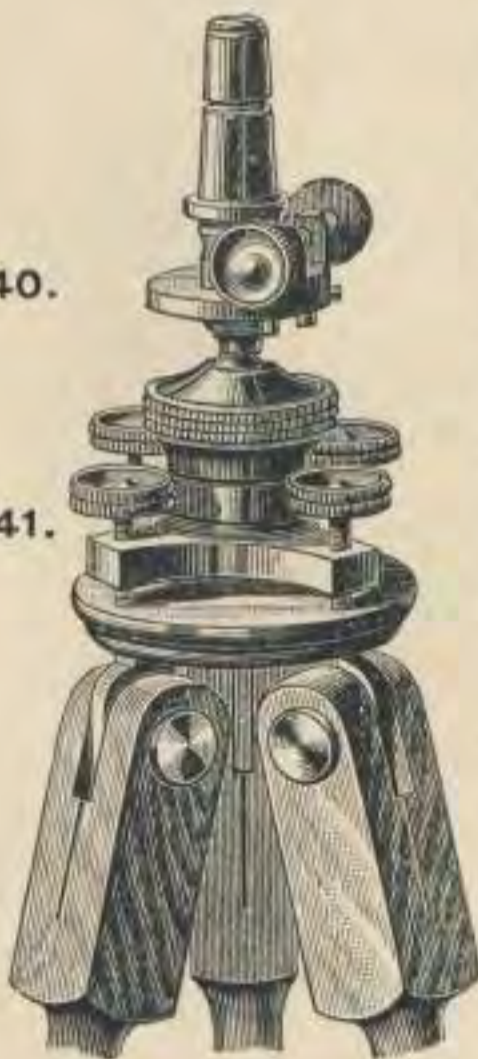

shown in No. 241, which is screwed to the top of the tripod like the ordinary leveling-head.

This can be used either with a simple ball-spindle, or with the compound ball with tangent screw, as shown in the cut.

The instrument is made approximately level upon the ball, and finally made truly horizontal by the leveling-screws.

The price of the leveling-adopter, without tripod or ball-spindle, is \$7.00; with tripod and compound tangent ball, as shown, \$19.00.

We also make for use with Surveyors' Compasses and Ver-
LEVELING- nier Transit-
HEAD. Compasses a leveling-head, consisting of parallel plates, four leveling-screws and clamp and tangent movement. (See Price-List, Nos. 176 and 242.)

This leveling-head furnishes a very stable support for the instrument, while affording the same conveniences for leveling and accurate adjustment in azimuth as the leveling-heads on the more expensive instruments.

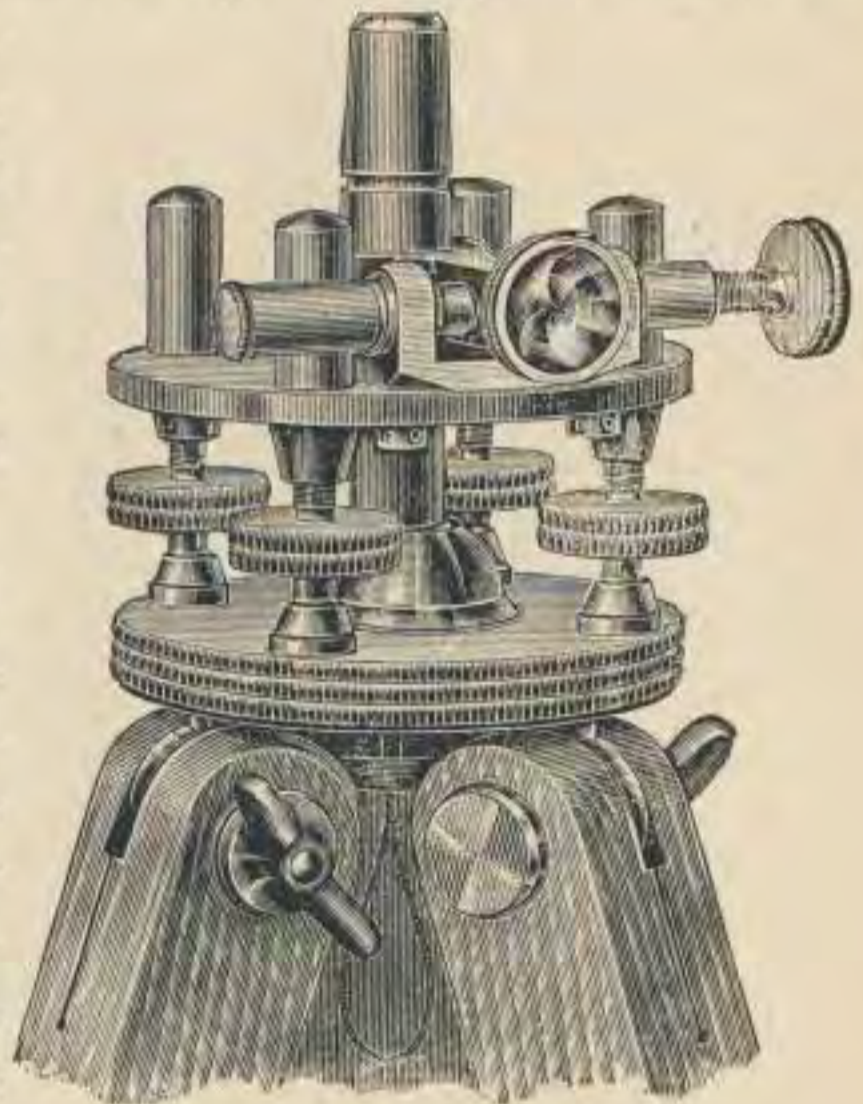

NOS. 176 AND 242.
LEVELING-HEAD.

The price complete with tripod, and fitted to the socket of the Compass or Vernier Transit, is \$18.00, or without the tripod, \$13.00.

THE TELESCOPIC SIGHT.

(PATENTED.)

We have for years applied to the sight-vanes of Compasses a telescope which can be put on and removed at will. This attachment has met with approval, hundreds being now in use in all parts of the country.

This telescope is furnished with the usual cross-wires, and is attached to a movable band which, as shown in the cut, can be slipped over the sight of a Compass, clamped at any point desired, and put in adjustment by any person who has a screw-driver and a steel adjusting-pin. To put this attachment in place, slip the band over the south sight of the Compass, having the telescope on the right-hand and the clamp-screw on the outer surface of the sight; and place the band as low as will allow the telescope to revolve in either direction without striking the Compass. This place should be marked by a line across the sight, or by a screw or pin on the inner surface of the sight, that the band may set at the same point in subsequent use.

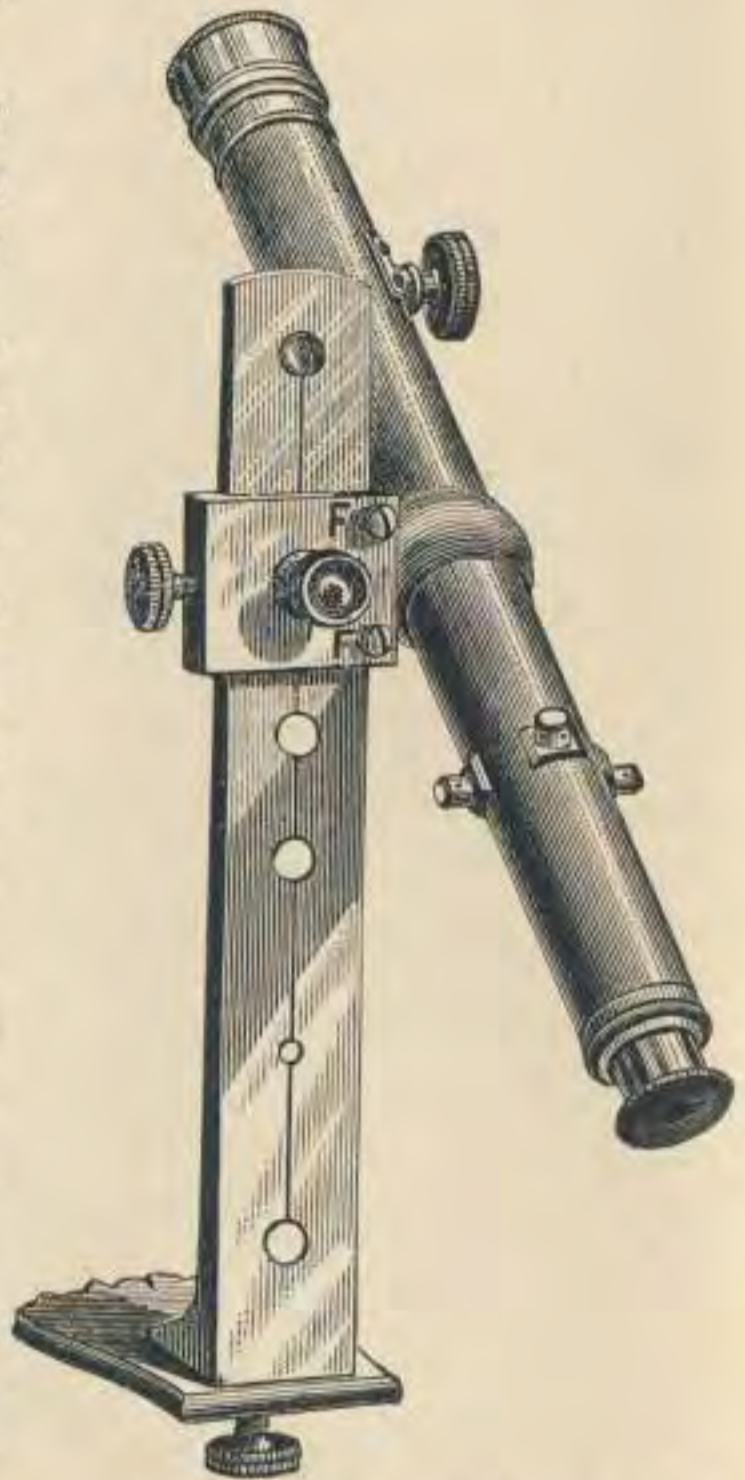

Price of Telescope No. 261 as shown, with movable band for attaching, \$17.00.

To fasten the band to the sight, first bring up the clamp-screw with a pressure just sufficient to hold the band to its place, then tighten the screw on the left until the band is against the right edge of the sight, and finally tighten the clamp-screw when the fastening will be complete.

To put the telescope in focus, turn the end of the eyepiece back or forth by the thumb and forefinger until by the spiral motion of the tube the cross-wires are brought into distinct view; the object-glass is then moved in either direction by the pinion on the side of the telescope until the object is clearly seen.

To make the adjustments, and indeed to do any correct work with a Compass, the spindle

ADJUSTMENTS. should be well-fitted and the level-bubbles should remain in the middle when the instrument is turned upon its spindle; the sights should also trace a vertical line when the Compass is level.

The means of effecting the adjustments will be understood by the engraving on page 120

and the outline cut here given, the former showing the rear, and the latter the front view of the band to which the telescope is attached.

To make the telescope axis horizontal, the Compass being in good order, first bring the levels into the middle;

TELESCOPE AXIS. place the band in position upon the sight, as before described; bring the telescope into focus and set the vertical cross-wire on the edge of a building, distant from fifty to sixty feet, and at a point near the

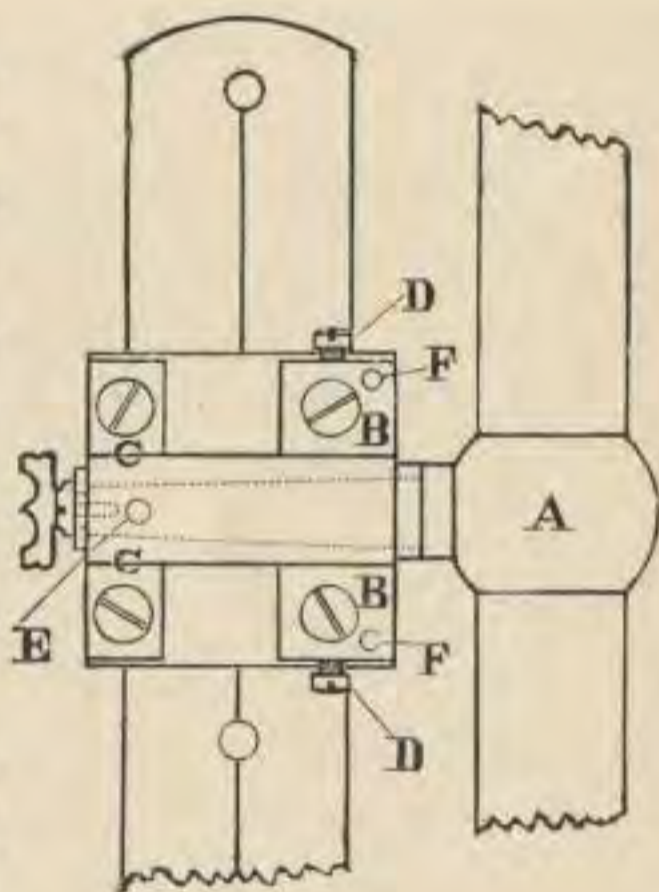

ground; clamp the Compass to the spindle, and raise the telescope to the top of the building. If the wire strikes to the right of the edge, it shows that the right end of the telescope axis is the lowest.

To raise it, loosen the screws, B B, C C, which confine the piece containing the spindle of the telescope, and by the screws, D D, the lower of which should be unscrewed and the upper one tightened, raise the telescope until the wire will follow the vertical line.

If the cross-wire strikes to the left when the telescope is raised, proceed exactly the reverse in making the correction, until the wire will follow the edge from one end to the other, when the adjustment will be complete. If the vertical cross-wire is not parallel with the edge, loosen the capstan-head screws, and turn the ring by the screw heads until the correction is made; and finally tighten the screws.

To make the second adjustment, that is, to bring the line of collimation into a position at right angles with the axis of the telescope so that the cross-wires will indicate two points in opposite directions in the same straight line, proceed as described on pages 19-21.

Find or place two objects, one on each side of the Compass, and from three hundred to four hundred feet distant from it, which the sight-vanes will intersect. Clamp to the spindle and sight through the telescope at either of the objects; if the vertical wire strikes to the right, loosen the screws, B B, and screw up those in front, marked F F, the ends only of which are shown in the figure, until the vertical wire bisects the object, looking again through the vanes to see that the same object is seen through both telescope and sights. If, however, the

cross-wire should strike to the left of the object, proceed in a manner exactly the reverse until the error is corrected.

This adjustment is always made by us before the attachment leaves our hands, and need not be disturbed except in case of accident or careless interference with the cross-wire screws; but it can be easily made by any Surveyor in a few moments and with very little practice.

When the adjustments are complete, the attachment can be put in place on the sight, and removed and replaced again in a moment, without danger of derangement in any of its parts.

The advantage of the telescope over the ordinary sight-vanes will be apparent to every one who has ever seen them compared, or who has given the matter a moment's reflection.

Much longer sights can be taken, either fore or back, and lines run up and down steep hillsides with the same facility as on level ground, and with more accuracy and with inexpressible relief to the eyes of the Surveyor, so often severely strained by the use of the sight-vanes of the ordinary Compass. Indeed it may be said that with this simple attachment every Compass can be transformed into a Transit-Compass at will, and thus all the advantages of the telescope brought within the reach of every Surveyor, at comparatively trifling cost.

The optical axis of the Telescopic Sight is at one side of the line of sight of the sight-vanes, but parallel with it. The difference between a sight taken
OPTICAL AXIS. with the sight-vanes and one taken with the telescope is, at a distance of two hundred feet, about two minutes; so small that it may be disregarded in any survey made with the magnetic needle. If *all* the lines are run with the Telescopic Sight, the angles measured will be accurate, as even this slight difference is entirely eliminated.

When desired the Telescopic Sight can be mounted upon an offset-standard, and so arranged that the line of sight is in line with the zeros of the compass-circle.

When in use this standard with the telescope attached to it is substituted for the south sight of the Compass.

The extra cost of this offset-standard is \$5.00.

When furnished with a new instrument the telescope is packed in the box with the Compass, or it can be safely forwarded by mail to any part of the country, securely packed in a suitable case in which it may be kept when not in use.

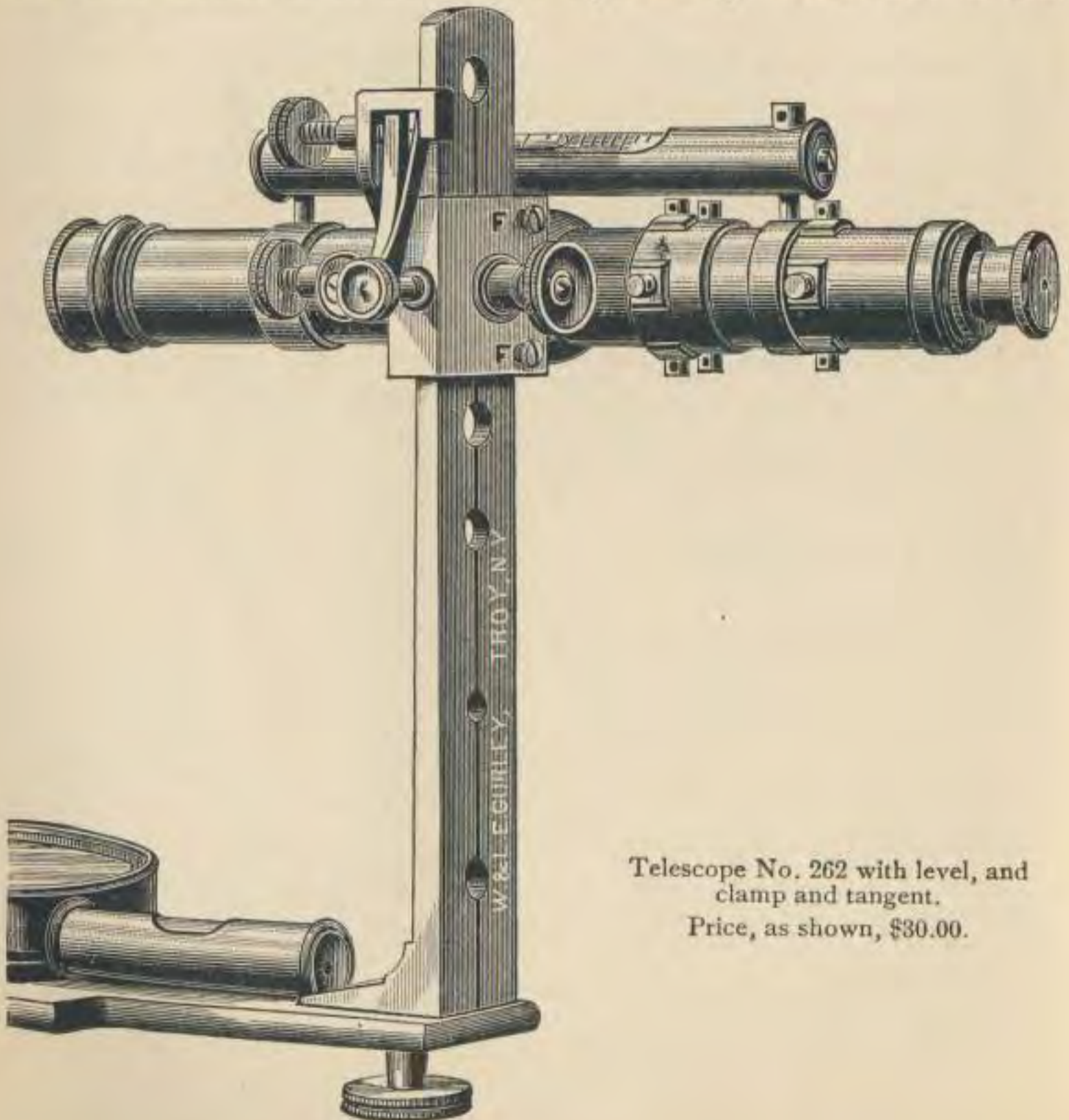

Telescope No. 262 with level, and clamp and tangent.

Price, as shown, \$30.00.

We make three styles of the **SIZES AND POWER.** Telescopic Sight, numbered 260, 261 and 262 in the price-list.

In No. 260, the telescope is about nine inches long, is fitted with plain cross-wires, and has a power of twelve diameters.

Nos. 261 and 262 have a power of eighteen to twenty diameters, and the telescopes are about nine inches long ; but the telescope of No. 262 has a greater diameter, allowing the insertion of stadia or micrometer wires, in addition to the ordinary cross-wires used in the other telescopes.

The extras of vertical circle three and one-half inches in diameter and reading to five minutes, level on telescope with graduated vial, and clamp and **EXTRA ATTACHMENTS.** tangent to axis, may be used with either of these Telescopic Sights. Whenever the level is used, it is of course necessary that the clamp and tangent to axis be added.

In the cut on page 124 the Telescope No. 262 is shown fitted with a level and clamp and tangent. For simple sighting the level and circle can of course be dispensed with, but in the use of the stadia wires the tangent movement is very desirable.

When measurements are to be recorded in chains and links, the stadia wires should be made to cover one foot at a distance of sixty-six feet ; if recorded in feet, the wires should cover one foot at a distance of one hundred feet.

The rod used with the stadia should be graduated to feet and decimals of a foot and provided with two targets one being fixed at some definite point while the other one can be moved as the Surveyor requires, the distance between the two targets being accurately read off by the vernier of the movable one ; or a self-reading rod, as

described on pages 184 and 186, may be used without target for short distances.

In using the stadia, the upper wire is brought by the tangent screw precisely upon the upper or stationary target, while the lower target is moved up or down until the lower wire exactly bisects its center line, when the rod is read and the distance recorded.

PRICES OF TELESCOPIC SIGHTS AND ATTACHMENTS.

No.		PRICE.	POST.
260.	Nine-inch Achromatic Telescope, power about twelve diameters.....	\$15.00	\$0.45
261.	Nine-inch Achromatic Telescope, larger diameter of object-glass and power about 20 diameters.....	17.00	.45
262.	Same Telescope as No. 261, but furnished with stadia wires for measuring distances.....	20.00	.50

We add to these Telescopic Sights the following extras, at prices annexed.

265.	Vertical Circle with vernier to five minutes.....	\$5.00	
266.	Level on Telescope	5.00	
267.	Clamp and Tangent to Telescope axis.....	5.00	
268.	Offset-Standard with Counterpoise, to bring the Telescope over the line of zeros.....	7.50	\$0.50

SMALLER FIELD-INSTRUMENTS.

POCKET SOLAR COMPASS.

POCKET RAILROAD COMPASS.

POCKET VERNIER COMPASS.

POCKET PLAIN COMPASS.

GEOLOGISTS' COMPASS.

CLINOMETER COMPASS.

MINERS' DIP-NEEDLE COMPASS.

DIAL COMPASS.

POCKET-COMPASSES.

WE MANUFACTURE a variety of small instruments so portable and yet so efficient that they are often used, in preference to the larger ones, for preliminary or reconnoissance work.

THE POCKET SOLAR COMPASS.



NO. 276.

Price as shown, with tripod, \$105.00

The Pocket Solar Compass has a needle three inches long and a limb four and one-half inches in diameter, graduated to half degrees and reading, by its one double vernier, to single minutes.

The arrangement of the plates is similar to that of the large Solar Compass, the lower plate carrying the sights **PLATES AND SIGHTS.** revolving around the upper or compass-plate, to which are attached the solar apparatus, levels, etc. There is a clamp and tangent movement to the horizontal limb and another to the whole instrument about its spindle, both made with an opposing spring.

The distance between the sights is nearly seven inches; the sights themselves are four and one-half inches high and have a slot and hair in half their height; they are hinged so as to fold down in packing.

The compass-circle is arranged with a pinion and is movable so as to set off the variation of the needle to five minutes; the needle has a lifting lever by which it is raised against the glass.

The solar apparatus is attached to the upper plate, and consists of the usual *hour*, *latitude* and *declination* arcs marked respectively A, C and B in the **SOLAR PARTS.** cut, and with an arm F F, to the last named, carrying the solar lenses and lines.

LATITUDE ARC. The latitude arc is graduated to half degrees, and reads by its vernier to five minutes of a degree.

DECLINATION ARC. The declination arc is graduated to quarter degrees, and reads by its vernier to single minutes of a degree.

The hour arc is graduated on its inner edge into hours and twelfths, or spaces of five minutes of time, the index of the declination arc above easily enabling one to read single

minutes of time. The hour-arc is made movable upon its supporting segment to either side, its outer edge being also

HOURLY-ARC. divided on the middle portion to spaces of five minutes of time, and read by a vernier upon the segment to single minutes. In this way the *equation of time* for any given day is set off at once, and the time given by the index of the hour-arc thus made to agree with mean time, or that given by the ordinary clock.

The solar lenses and lines are placed as in the larger instruments, the declination arc being also
SOLAR LENSES. reversible as the sun changes from north to south of the equator.

When packed in the case, the declination arc with its arm is detached from the hour-arc, and this itself, together with the latitude arc, folds close to the compass-box.

The Pocket Solar Compass is used either upon a ball-spindle with staff mountings, or as shown, upon a light tripod like the other Pocket-Compasses, and often with small leveling-head with clamp and tangent screws.

Sometimes a side telescope with counterpoise is used in addition to the sight-vanes.

The adjustments and use of the Pocket Solar Compass are substantially the same as those of the large Solar Compass already described, and its indications
ADJUSTMENTS. are so accurate that it will give the true meridian within an error of one minute, which, taken in connection with the deflection of the magnetic needle, will indicate with certainty the presence and direction of veins of magnetic iron ore.

We have the assurance of competent Surveyors that, while it is much more portable, it is also very nearly as accurate as the large Solar Compass. Its weight, without box or tripod, is four and three-quarter pounds.



NO. 285.

Price as shown, with tripod, \$45.00.

POCKET RAILROAD COMPASS.

The instrument shown is a single vernier Railroad Compass in miniature. The limb is five inches in diameter and reads by vernier to single minutes. The needle is three and one-half inches long, and its variation can be set off to single minutes.

This instrument has the improved spring tangent, and the vernier placed at an angle of thirty degrees with the sights. The sights are made to fold down closely for convenience in packing, and are each made half slot and half hair so that fore and back-sights may be taken without turning the instrument.

The Pocket Railroad Compass can be used for a great variety of work and, with light extension tripod, is especially adapted for surveys of mines, where angles must be taken independently of the needle.

The price, with staff mountings, is \$40, with light tripod \$45, and with extension tripod \$50.

POCKET RAILROAD COMPASS WITH TELESCOPE.

In the cut on page 133 we show a form of the Pocket Railroad Compass which is adapted to receive the Telescopic Sight.

The plates are circular, and the sights are made half slot and half hair, and are jointed so as to fold down close to the glass. The needle is four and one-half inches long, and there is an arc with vernier, on the outside of the compass-plate, for setting off the variation of the needle.

The instrument has a limb reading to single minutes by a vernier placed inside the compass-circle. A clamp and tangent movement is added to the spindle.

The sights being inclined to each other as shown, a short standard with two projecting arms below and supporting the telescope is secured by two milled head screws to the tops of the sights, and thus a telescope is placed in position, making the instrument in effect a very light Surveyor's Transit.

The attachments of vertical circle, level and clamp and tangent, as shown in the figure, may also be added, and

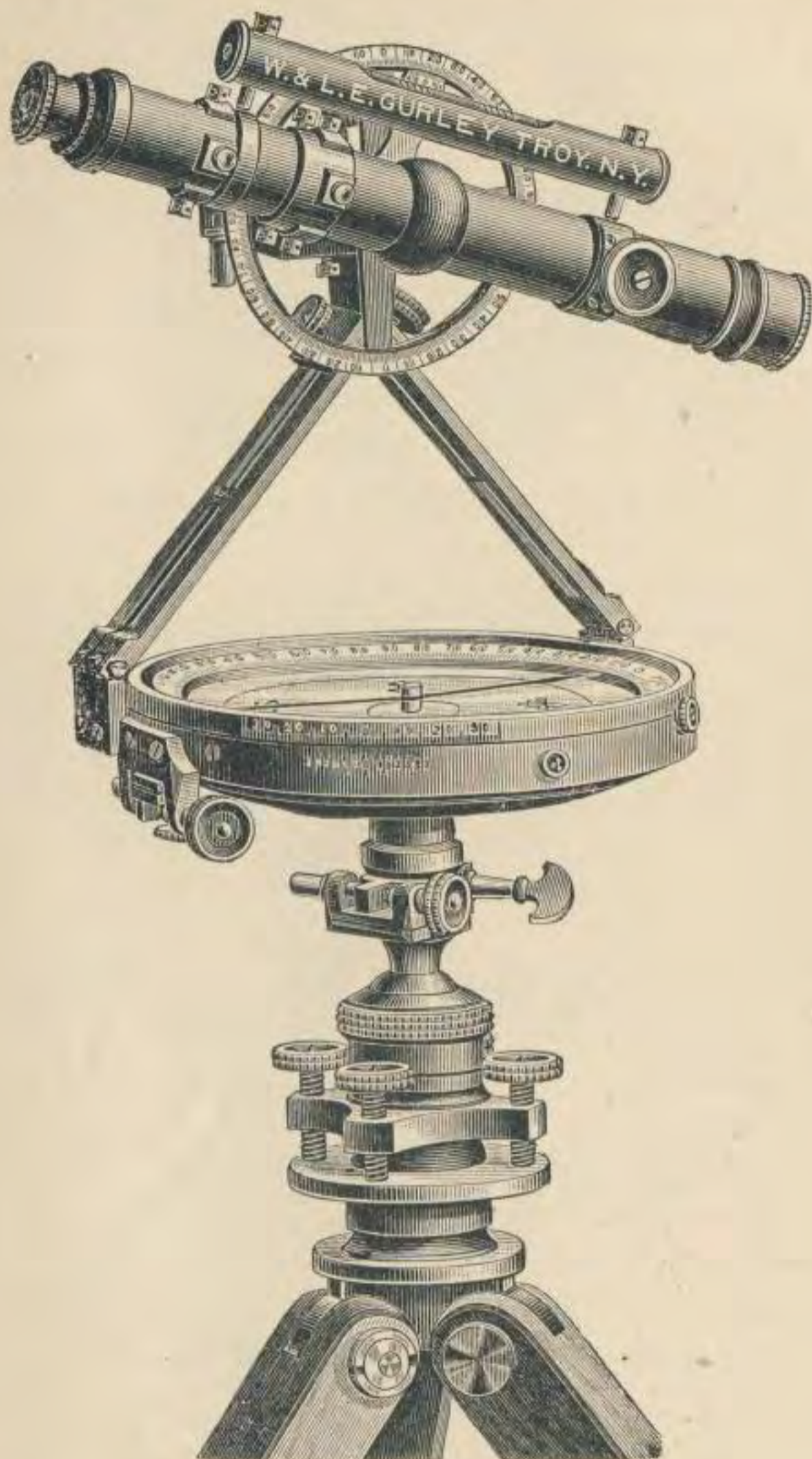

No. 293.

Price, as shown, \$83.00.

thus the means furnished for taking grades and running levels with accuracy sufficient for the common practice of the Surveyor.

When the telescope is added, the sights are placed to one side of the line of zeros, and the telescope is then brought into that line and over the center of the instrument.

The short standard can be detached with the telescope and placed in the case, or replaced, in a few moments' time without deranging any of the adjustments.

The Pocket Railroad Compass can be used either on a staff or with small tripod, and, if desired, with small leveling-head, as shown.

WEIGHT OF THE POCKET RAILROAD COMPASSES, including the brass mountings of the staff, but without tripod :

No. 285, $3\frac{1}{2}$ -inch Compass, about.....	4 lbs.
No. 288, $4\frac{1}{2}$ -inch Compass, about.....	$4\frac{1}{2}$ "
Nos. 290, 291 and 292, $4\frac{1}{2}$ -inch Compass, about.....	$6\frac{1}{2}$ "
No. 293, $4\frac{1}{2}$ -inch Compass, about.....	$7\frac{3}{4}$ "

PRICES.

No.		PRICE.
285.	Pocket Railroad Compass, one vernier to limb, limb 5 inches diameter reading to 1 minute, and with clamp and tangent, $3\frac{1}{2}$ -inch needle, folding sights, two levels and staff mountings, see page 131.....	\$40.00
288.	Pocket Railroad Compass, one vernier to limb, with clamp and tangent, limb inside the compass-circle and reading to 1 minute, $4\frac{1}{2}$ -inch needle, folding sights, two levels and staff mountings.....	33.00
290.	Pocket Railroad Compass, $4\frac{1}{2}$ -inch needle, clamp and tangent to limb, limb reading to 1 minute, clamp and tangent to main spindle or socket, and fitted with our Telescopic Sight No. 260, with the extras of level, vertical circle to 5 minutes, and clamp and tangent to telescope axis. Price, including tripod.....	73.00
291.	Same as above, but with Telescopic Sight No. 261.....	75.00
292.	" " " " " " " " No. 262.....	78.00
293.	" " " " " " " " No. 262, and with leveling-adopter, as shown on page 133.....	83.00



No. 300 — Price as shown, $3\frac{1}{2}$ -inch needle, with tripod, \$21.00.

No. 305 — With $4\frac{1}{2}$ -inch needle, and tripod, \$23.00.

POCKET VERNIER COMPASS.

The Pocket Vernier Compass is an excellent and portable instrument for preliminary work, having a fine needle and a vernier and clamping nut by which the sights can be placed at an angle with the line of zeros, so as to set off the variation of the needle as with the Vernier Compass.

The instrument has folding sights, two levels and staff mountings, and is packed in a mahogany case.

The sights are made with a slot in the south vane, and a hair in the north vane for readily finding the object; they

also fold down to the Compass when it is packed in the case. The Compass is furnished with staff mountings, and is often used with a light tripod.

When desired to set off the variation more readily, a rack movement with pinion is supplied at an extra cost of \$4.00.

We make two sizes of the Pocket Vernier Compass, having needles respectively three and one-half and four and one-half inches long; both have the compass-circle graduated to half degrees. In the smaller size the variation vernier reads to five minutes; in the larger size the variation may be set off to single minutes.

Compass with $3\frac{1}{2}$ -inch needle weighs about $1\frac{3}{4}$ lbs.
 " " $4\frac{1}{2}$ " " " " $2\frac{3}{4}$ "

POCKET VERNIER COMPASS WITH TELESCOPE.

The arrangement for attaching a telescope and extras to the sights of the four and one-half-inch Pocket Vernier Compass is shown on page 137, making this little instrument a Transit-Compass for ordinary land-surveying and reconnoissance, with power to give levels and grades with accuracy sufficient for ordinary practice. The sights in such an arrangement are placed at one side, that the telescope may be directly over the center, and the instrument should have a clamp and tangent movement for the spindle, as shown in the figure. When packed for transportation, the telescope and support are detached from the sights and packed separately in the case. Staff mountings are always furnished with these Compasses; and a light tripod, as shown, is very generally added.

WEIGHT. The weight of Compass No. 312 without tripod is about four and one-half pounds; the tripod weighs about four pounds



No. 312.

Price, complete as shown, \$63.00.

PRICES.

No.					
310.	Pocket Vernier Compass, 4½-inch needle, with clamp and tangent to the main spindle or socket, and fitted with our new Telescopic Sight No. 260, with the extras of level, vertical circle to 5', and clamp and tangent to telescope axis. Price, including tripod.....				\$58.00
311.	Same as above, but with Telescopic Sight, No. 261.....				60.00
312.	“ “ “ “ “ “ No. 262, as shown.....				63.00

POCKET PLAIN COMPASSES.



NOS. 316 AND 318.

Besides the Pocket Vernier Compass, we also furnish a similar instrument without a vernier, which is often found very serviceable. The Pocket Plain Compasses are made with two and one-half and three and one-half-inch needles, and supplied with levels and staff mountings or not, as may be desired. They are packed in a light mahogany case, the sights folding down close to the glass.

PRICES.

No.		PRICE.	POST.
315.	Pocket Plain Compass, 2½-inch needle, with folding sights.....	\$ 8.00	\$0.25
316.	Pocket Plain Compass, 2½-inch needle, with folding sights and staff mountings.....	10.00	.35
317.	Pocket Plain Compass, 3½-inch needle, with folding sights.....	10.00	.40
318.	Pocket Plain Compass, 3½-inch needle, with folding sights and staff mountings.....	12.00	.50
319.	Pocket Plain Compass, 3½-inch needle, with folding sights, two levels and staff mountings.....	13.50	.50



No. 327.

A convenient appliance is shown in No. 327, at *a*, for use with Pocket-Compasses Nos. 275 to 319, **LEVELING-ADOPTER.** giving in connection with the ball a rapid and accurate means of leveling any of the smaller instruments. The attachment weighs less than one pound, and can be used on the tripod by merely removing the brass cap. Its value and use are apparent upon inspection. Price, \$5.00.

GEOLOGISTS' COMPASS.

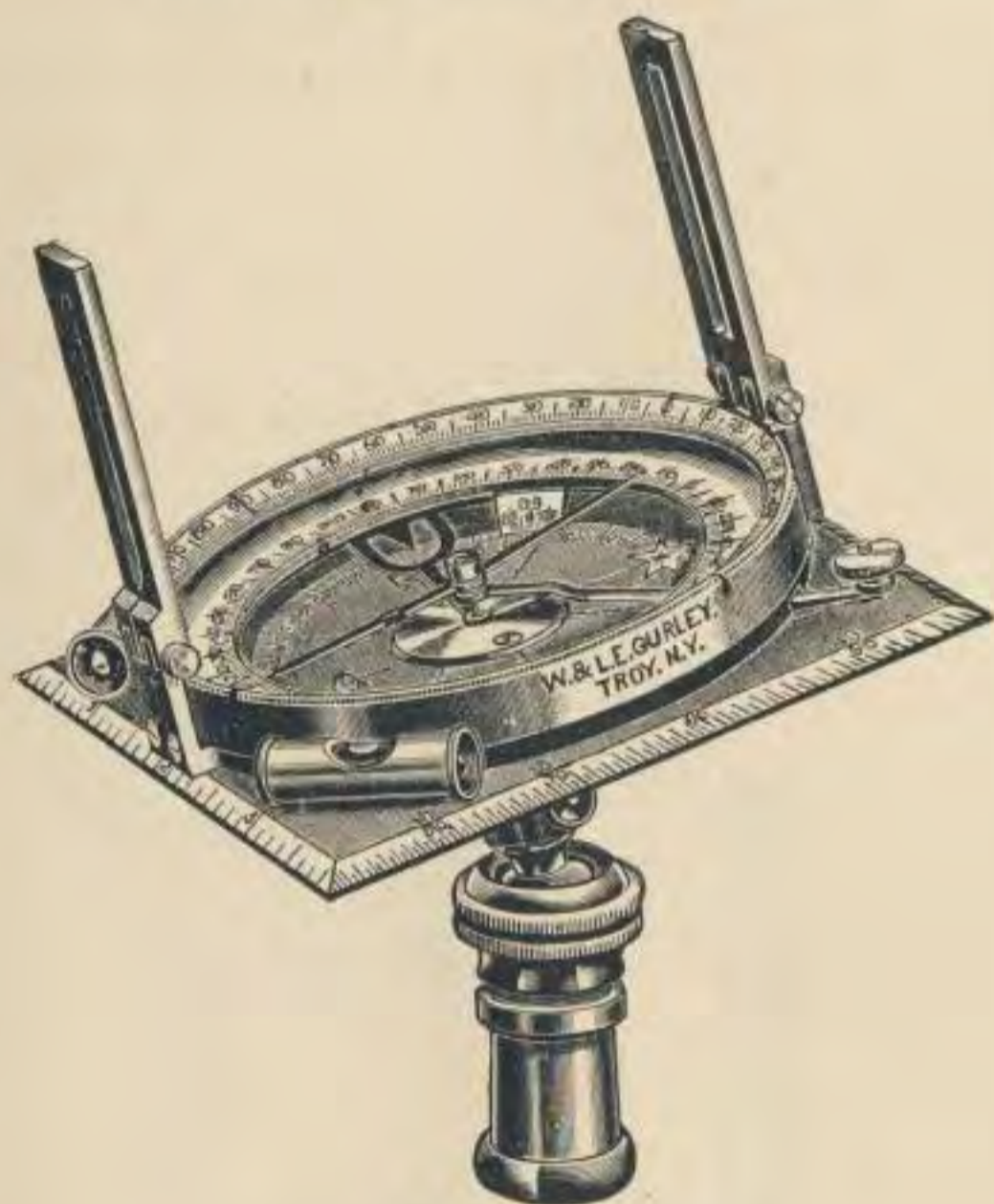
**NO. 335.**

Price, as shown, \$24.00.

We show here a popular instrument for topographical work, known as the Geologists' Compass. It is made of aluminum to secure light weight, and has a needle two and five-eighths inches long enclosed with its compass-circle in a circular box set upon a base four inches square, the edges of which are beveled and graduated, two of them for a tangent scale and the other two with scales of eighths and tenths of inches. The compass-circle is made movable and, by a vernier attached to it on the inside, the variation of the needle can be set off to five minutes. On the south side of the compass-face is an arc of one hundred and

eighty degrees, figured on each side of the zero line from 0 to 90. The index point, a little pendulum hung from the center-pin, indicates on this arc the angle of slope when the Compass is placed so that it rests on its south side. On the outside of the circular box containing the compass-circle is a movable circle, beveled and graduated on its upper edge and figured from 0 to 90, and having at each quadrant a slit cut for sighting. Two folding sights are attached to the edge of the circular box. The Compass is supported on a simple ball-spindle and socket with staff mountings, and is packed in a mahogany box.

CLINOMETER COMPASS.

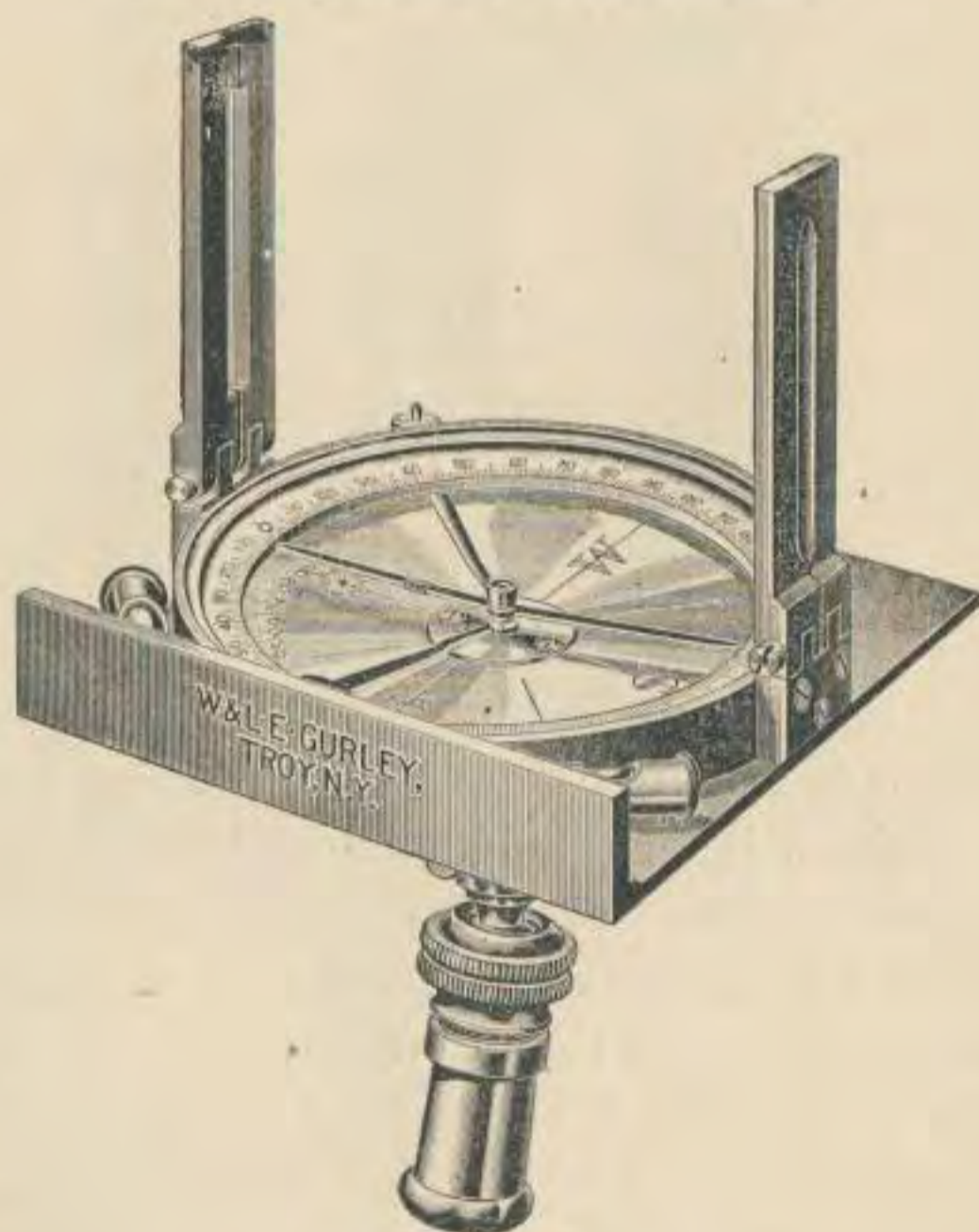

NO. 338.

Price, as shown, \$16. (See page 141.)

CLINOMETER COMPASS.

Another form of Pocket-Compass is shown on page 140. It is made of brass, and is known as the Clinometer Compass. It has a needle three and one-half inches long, enclosed with its compass-circle in a circular box set upon a base four and one-half inches square. On one side of this base is placed the rectangular side upon which the Compass may be set in determining grades.

The small pendulum swinging from the center-pin designates, by its index, the degree of slope upon the graduated arc on the compass-face. Two folding sights are attached to the edge of the circular box, and two small levels are placed at right angles with each other upon the base. The Compass is supported upon a simple ball-spindle and socket, with staff mountings, and is packed in a mahogany box.

MINERS' OR DIP-COMPASS.

The Dip-Compasses, two forms of which are shown on this page, consist essentially of a magnetic needle so suspended as to move readily in a vertical direction, the angle of inclination, or "dip," being measured upon the graduated rim of the compass-circle.

When in use, the ring or bail is held by the hand, the compass-box by its own weight takes a vertical position, and it must also be in the plane of the magnetic meridian.

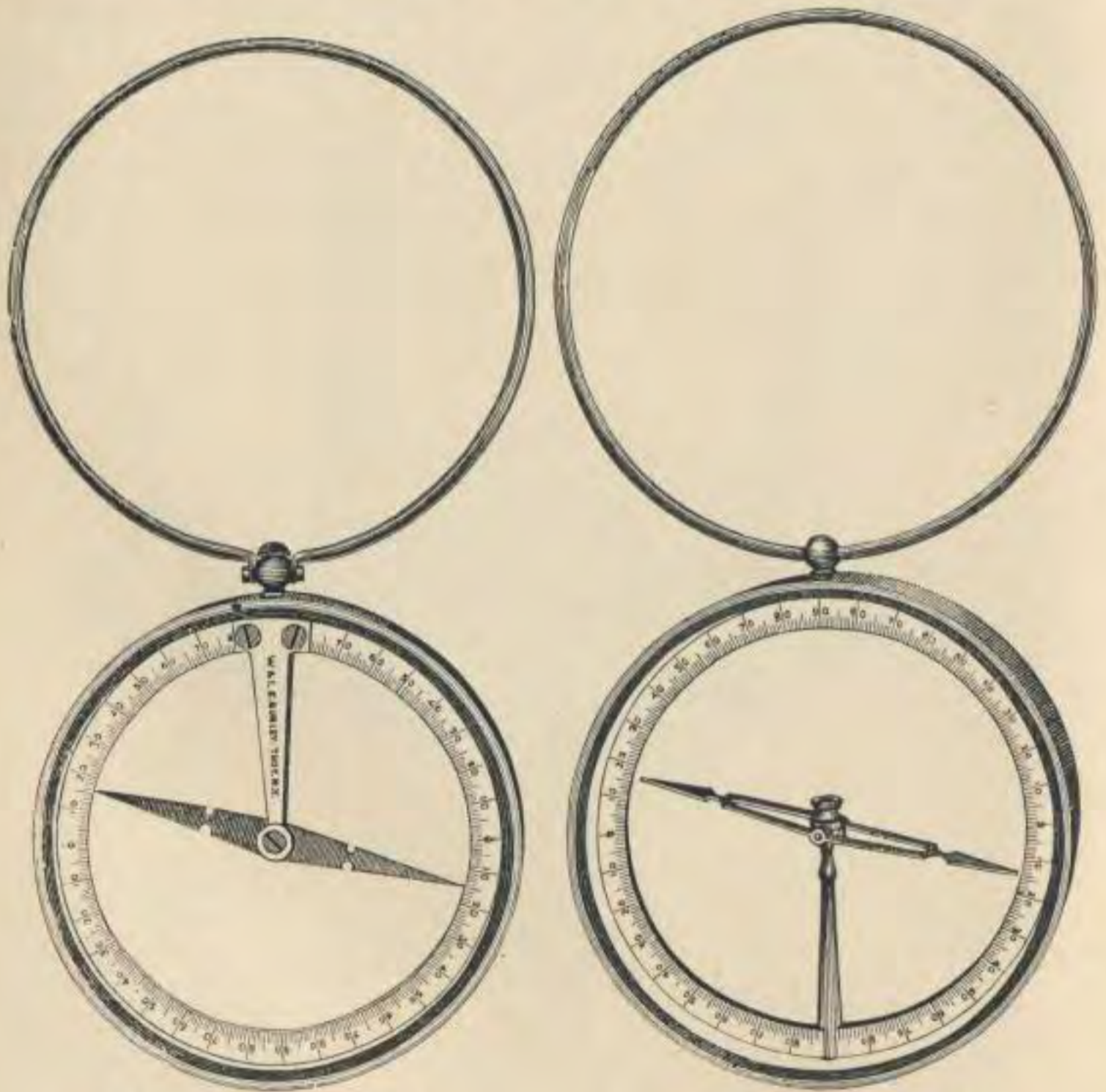
**NOS. 340 AND 341.**

Price, \$12.00.

NOS. 344 AND 345.

Price, \$12.00 and \$15.00.

In this position, the needle, when unaffected by the attraction of iron, assumes a horizontal line, as shown by the zeros of the circle. When brought over any mass of magnetic iron ore it dips, and thus detects the presence of such ore with certainty.

If the Miners' Compass, No. 340 or 341, is held horizontal it serves as an ordinary Pocket-Compass, and thus indicates the magnetic meridian, in the plane of which it should be held when used to ascertain the dip.

Several different styles of this instrument are made. Those shown as Nos. 340 and 341, with a three-inch needle, have the two sides of glass, and are provided with a stop for the needle which is worked by the little brass knob between the ends of the ring.

THE NORWEGIAN COMPASS, Nos. 344 and 345, is a modification of an instrument used in northern Europe.

It has a needle either three or four inches long, resting upon a single vertical pivot so as to move freely in a horizontal direction. At the same time, being attached to the needle-cap by two delicate pivots, one on each side, it is free to dip like the needle of the ordinary Miners' Compass.

PRICES.

No.		PRICE.	POST.
340.	Miners' Compass, 3-inch needle, glass on both sides, wood box, stop to needle.....	\$12.00	\$0.25
341.	Miners' Compass, 3-inch needle, glass on both sides, brass covers, stop to needle.....	12.00	.35
344.	Norwegian Compass, 3-inch needle, glass on both sides, brass covers.....	12.00	.35
345.	Same as No. 344, but with 4-inch needle.....	15.00	.50

NOTE.—No instrument made that will indicate the presence of gold or silver.

BRASS DIAL COMPASS.

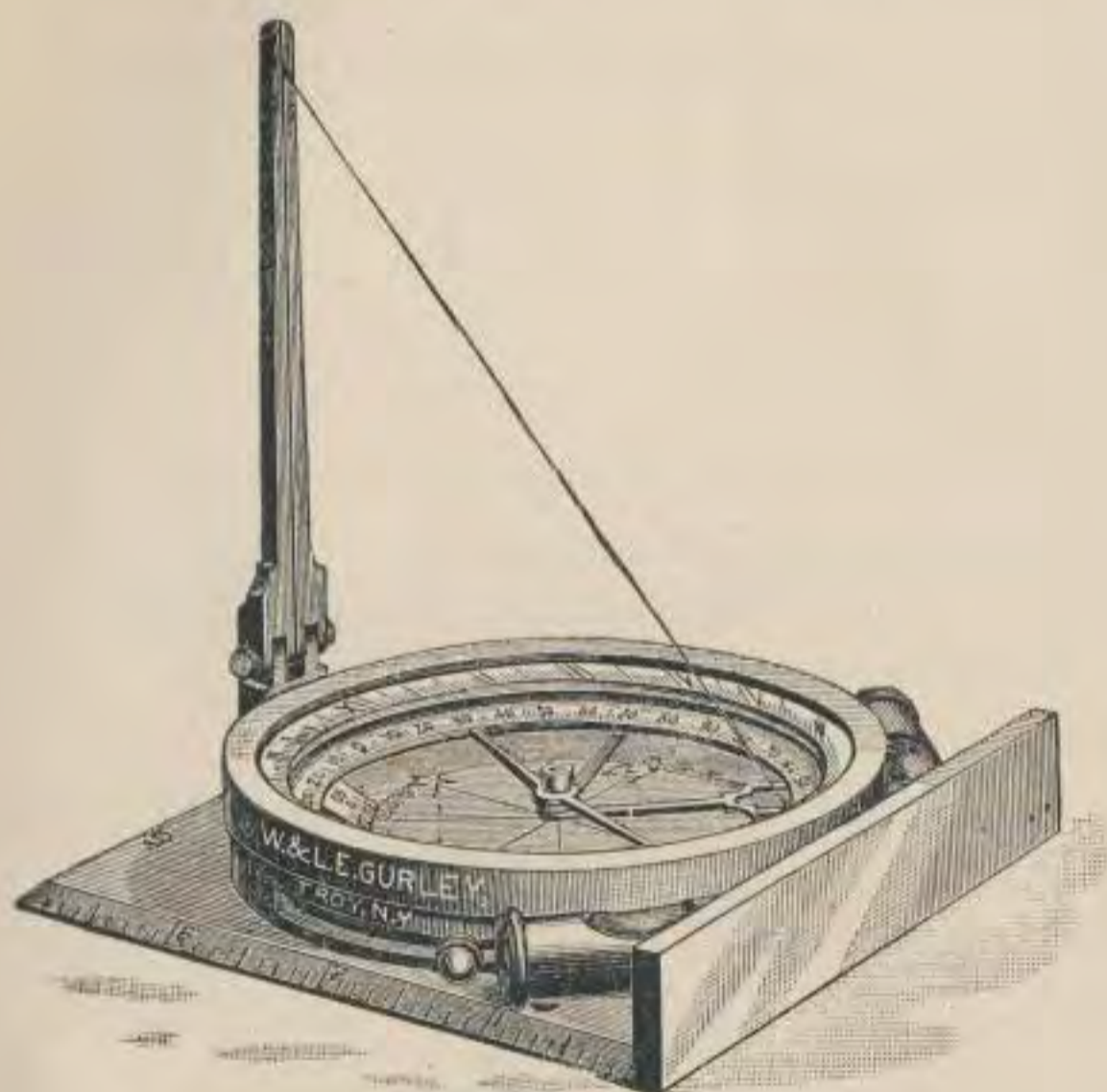

No. 348.

Price, \$18.00.

This little instrument has a needle two and five-eighths inches long, and with its compass-circle is enclosed in a circular box set upon a base four inches square, three edges of which are chamfered and graduated, the one on the W-side of the Compass into inches and tenths and the two others into degrees and half degrees, and figured from a center on the south-west corner of the base.

The compass-circle is movable, in order to set off the variation of the needle, and has a vernier attached to it on the inside, reading a graduated arc on the face of the Compass to five minutes of a degree.

There is also on the south side of the face an arc of one hundred and eighty degrees, figured from 0 to 90 on each side of the south or zero-line of the face.

A little pendulum with index-point hung from the center-pin reads this arc when the Compass is set up vertical on the raised south edge, thus making it a clinometer or slope-measurer.

The sight is hinged so as to fold in packing, but when erect makes taut a fine silk thread, attached at one end to the sight and at the other to a brass hour-circle above the compass-glass, at an angle with the plane of the hour-circle equal to that of the latitude of the place where the Compass is used. The hour-circle is divided for any required latitude, like that of a sun-dial, the hair serving as a gnomon to give apparent time with the sun.

The Dial Compass is extensively used in this country in regions where there is local attraction and it is desirable to have a simple means of determining the meridian independently of the needle.

This can be easily and quickly done by turning the Compass, with dial graduated for the latitude of the place, until the shadow of the string when the Compass is held level indicates local time on the dial. The line of sight will then be in the meridian.

The needle may then be set to the meridian by laying off the variation and any deflection of the needle from the true meridian will indicate the presence of veins of magnetic iron ore.

Extra hour-arcs, graduated for any latitude and to fit the same Compass, can be furnished, if desired, at an extra cost of \$5.00 each.

Staff mountings, including ball-spindle and socket, are also furnished, when desired. The extra cost is \$2.50.

ALUMINUM DIAL COMPASS.

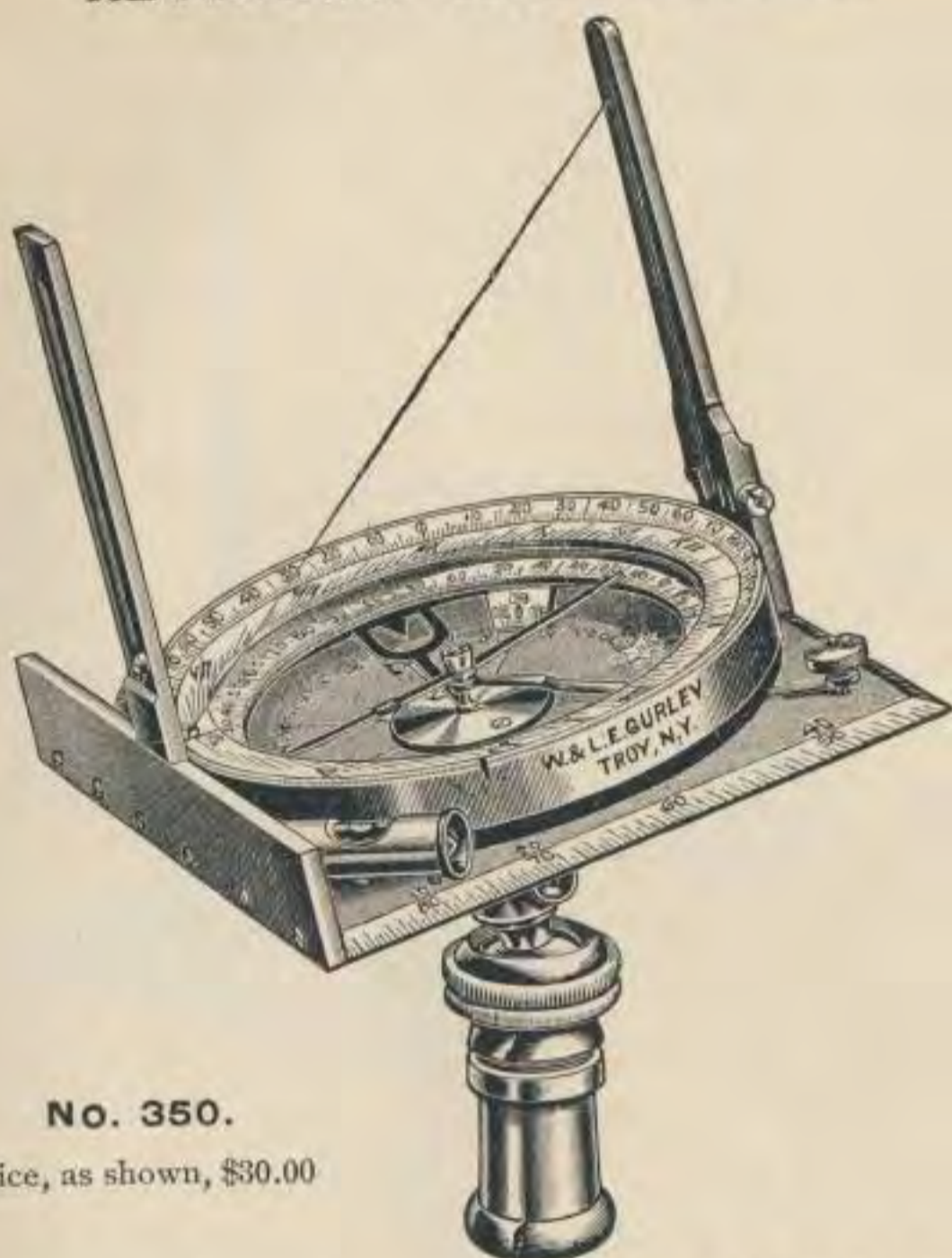

No. 350.

Price, as shown, \$30.00

The illustration shows an improved form of the Dial Compass, made of Aluminum, and differing from our usual pattern in several respects. This new instrument is of the same size and has the same parts as the common Dial Compass, shown on page 144, and in addition has a movable circle graduated on its beveled edge from zero to ninety degrees. At each quadrant there is a slit cut for sighting, and an open sight is furnished with the Compass, to be placed upon the clinometer base when desired, and used in conjunction with the regular sight. The instrument is mounted upon a small ball-spindle and socket with staff mountings, and is packed in a mahogany box.

LEVELING-INSTRUMENTS

ENGINEERS' Y-LEVELS.

ARCHITECTS' Y-LEVELS.

DRAINAGE LEVELS.

ENGINEERS' Y-LEVELS.

OF THE different varieties of Leveling - Instruments, the Y-Level is universally preferred by American Engineers on account of its easy adjustment and superior accuracy.

Of these Levels we manufacture five different sizes, having telescopes twenty-two, twenty, eighteen, fifteen and twelve inches in length. The cut on page 149 represents our twenty-inch Y-Level.

We shall consider the several parts of the instrument in detail.

The Telescope has near its ends two rings of bell-metal, turned very truly and of exactly the same diameter.

TELESCOPE. On these rings it revolves in the Ys, or it can be clamped in any position, when the clips of the Ys are brought down upon the rings, by pushing in the tapering pins.

The telescope has a rack and pinion movement to both object-glass and eyepiece, and an adjustment for centering the eyepiece, shown at A A in the sectional view of the instrument, page 150, and another seen at C for insuring the accurate projection of the object-glass slide.

Both of these are completely concealed from observation and disturbance by thin rings which screw over them.

The telescope has also a shade over the object-glass, so made that, while it may be readily moved on its slide over the glass, it cannot be dropped off and lost.

A small Compass, without sights and with three-inch needle, is sometimes attached to the telescope and used to obtain the bearing of lines when desired ; its extra cost is \$10.00.

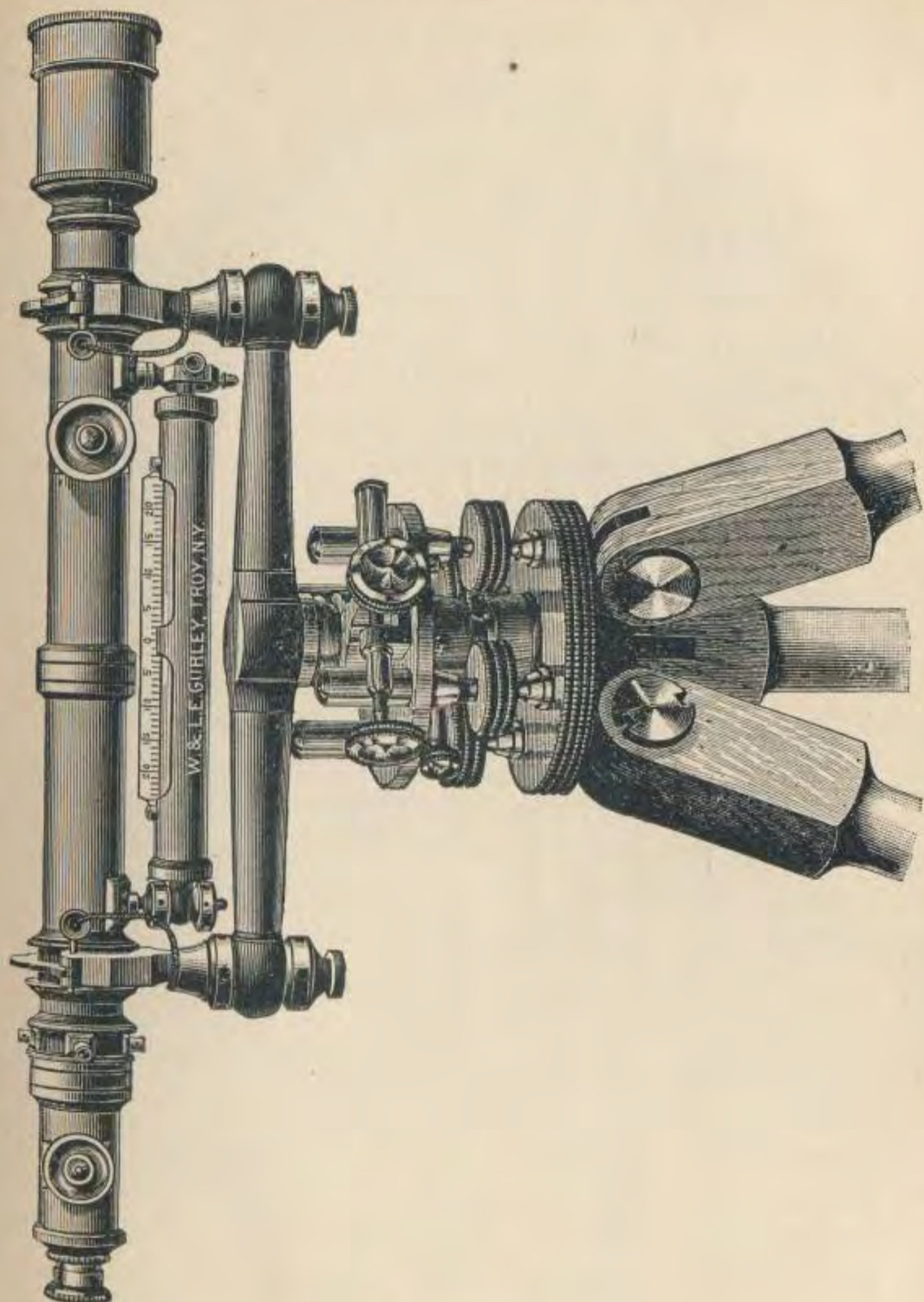

No. 376.

20-INCH Y-LEVEL.

Price as shown, including Tripod, \$110.00.

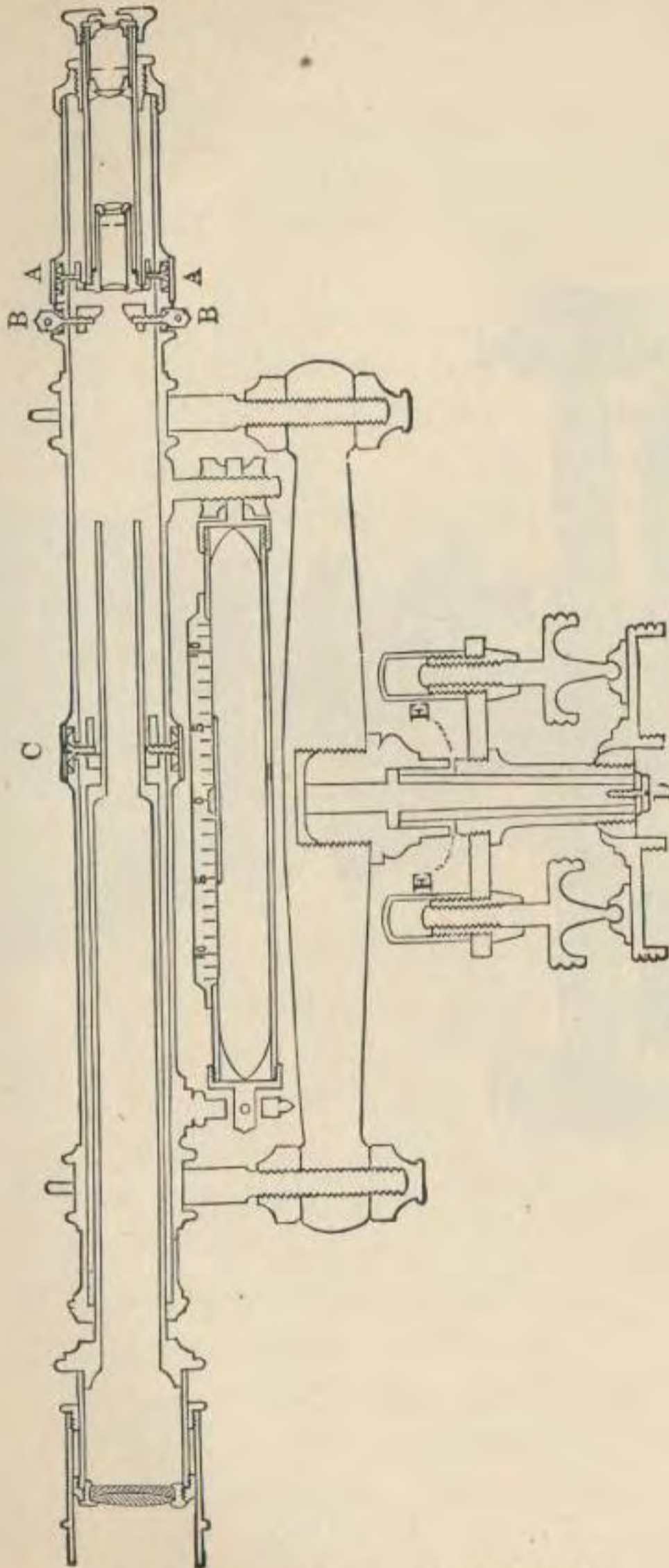

SECTIONAL VIEW OF Y-LEVEL.

A Horizontal Circle, three and one-half inches in diameter, is fitted, when desired, to the leveling-head of the **HORIZONTAL CIRCLE.** Y-Level. The circle is graduated to whole degrees, and is read by vernier to five minutes. The extra cost for this attachment is \$15.00.

The interior construction of the telescope will be readily understood from the sectional cut, page **OBJECT-GLASS SLIDE.** 150, which exhibits the adjustment that insures the accurate projection of the object-glass slide.

As this is peculiar to our instruments, and is always made so permanently as to need no further attention at the hands of the Engineer, we here describe the means by which it is effected somewhat in detail.

The necessity for such an adjustment will appear when we state that it is almost impossible to make a telescope tube perfectly straight on its inner surface.

Such being the case, it is evident that the object-glass slide which is fitted to this surface, and moves in it, must partake of its irregularity, so that the glass and the line of collimation depending upon it, though adjusted in one position of the slide, will be thrown out when the slide is moved out or in.

To prove this, let any Level be selected, which is constructed in the usual manner, and the line of collimation adjustment upon an object taken as near as the range of the slide will allow; then let another be selected as distant as may be clearly seen; upon this revolve the wires and they will generally be found out of adjustment, sometimes to a degree fatal to any confidence in the accuracy of the instrument. The arrangement adopted by us to correct this imperfection, and which perfectly accomplishes its purpose, is shown in the sectional cut.

Here are seen the two bearings of the object-glass slide, one being in the narrow bell-metal ring which slightly con-

tracts the diameter of the main tube, the other in the small adjustable ring, also of bell-metal, shown at C, and suspended by four screws in the middle of the telescope.

Advantage is here taken of the fact that the rays of light are converged by the object-glass, so that none are obstructed by the contraction of the slide except those which diverge and which ought always to be intercepted and absorbed in the blackened surface of the interior of the slide.

Now, in such a telescope, the perfection of movement of the slide depends entirely upon its exterior surfaces at the points of the two bearings. These surfaces are accurately turned, concentric and parallel with each other, and, being fitted to the rings, it is only necessary to adjust the position of the smaller ring so that its center will coincide with that of the optical axis of the object-glass. When this has been done no further correction will be necessary unless the telescope should be seriously injured. The manner in which the adjustment of the object-glass slide is effected will be considered when we come to speak of the other adjustments.

RACK AND PINION. As seen in the cut, the telescopes of our Levels are furnished with rack and pinion movement to both object-glass and eyepiece.

The advantages of an eyepiece pinion are that the eyepiece can be shifted without danger of disturbing the telescope, and that the wires are more certainly brought into distinct view, so as to avoid any error of observation arising from what is termed the instrumental parallax.

The level-tube, with ground vial and scale, is attached to the under side of the telescope, and furnished at different ends with the usual movements in both horizontal and vertical directions.

LEVEL-VIAL.

The aperture of the tube, through which the glass vial appears, is about five and one quarter-inches long, and is crossed at the middle by a small rib or bridge which greatly strengthens the tube.

The level-vial is made of glass tube, selected so as to have an even bore from end to end, and finely ground on its interior surface so that the run of the air-bubble may be uniform throughout its whole range. The level-scale which extends over the whole length is graduated to tenths of an inch and figured at every fifth division, counting from zero at the middle of the bridge. The scale is set close to the glass.

The sensitiveness of a ground level is best determined by an instrument called a level-tester, consisting of a bar with two Ys to hold the level-tube, and pivoted at one end, while at the other end is a micrometer wheel graduated into hundredths, and attached to the top of a fine-threaded screw which raises the end of the tester very gradually. The number of divisions passed over on the perimeter of the wheel, in carrying the bubble over a tenth of an inch on the scale, is the index of the delicacy of the level. In the tester which we use, a movement of ten divisions of the wheel to one of the scale indicates the degree of delicacy generally preferred for railroad engineering. For canal work a more sensitive bubble is often required, as, for instance, one of seven or eight divisions of the wheel to one of the scale.

The Ys of our levels are made large and strong, of the best bell-metal, and each have two nuts adjustable with the ordinary steel pin. The clips are brought
Ys. down on the rings of the telescope tube by the Y-pins, which are made tapering so as to clamp the rings firmly. The clip of one of the Ys has a little pin pro-

jecting from it, which, entering a recess filed in the edge of the ring, insures the horizontal position of the cross-wire.

The level-bar is made round, of the best bell-metal, and shaped for greatest strength in the parts most liable to sudden strains. Connected with the level-bar is the head of the leveling-socket.

LEVEL-BAR.

The socket is compound; the inner spindle, D, see page 150, upon which the whole instrument is supported, is made of steel and nicely ground so as to turn evenly and firmly in a hollow cylinder of bell-metal; this again has its exterior surface fitted and ground to the main socket, E E, of the leveling-head.

SOCKET.

The bronze cylinder is held upon the spindle by a washer and screw, the head of the latter having a hole in its center through which the string of the plummet is passed.

The upper part of the instrument, with the socket, may be detached from the leveling-head; and this also, as is the case with all our instruments, can be unscrewed from the tripod head; but all the Y-Levels made by us are packed in the case complete with leveling-head, experience having shown that there is thus less danger of injury in transportation. It will be seen from the cut that the arrangement just described allows long sockets and yet brings the whole instrument down as closely as possible to the leveling-head, both objects of great importance in the construction of any instrument.

The leveling-head has the same plates and leveling-screws as described in the account of the Engineers' Transit. The tangent screw has also an opposing spring as there described.

LEVELING-HEAD.

For the fifteen-inch level we make a leveling-head similar to that used with the lighter Engineers' Transit.

THE ADJUSTMENTS.

The adjustment of the object-glass slide is peculiar to our instruments, and is always made by us so permanently as to need no further attention at the hands of the Engineer, unless in case of derangement by accident.

To adjust the object-glass slide, the maker selects an object as distant as may be distinctly observed, and upon **OBJECT-GLASS SLIDE.** it adjusts the line of collimation, in the manner described on page 157, making the center of the wires to revolve without passing either above or below the point or line assumed.

In this position, the slide will be drawn in nearly as far as the telescope tube will allow.

With the pinion-head he then moves out the slide until an object, distant about ten or fifteen feet, is brought clearly into view; again revolving the telescope in the Ys he observes whether the wires will reverse upon this second object.

Should this happen to be the case, he will assume that, as the line of collimation is in adjustment for these two distances, it will be so for all intermediate ones, since the bearings of the slide are supposed to be true and their surfaces parallel with each other.

If, however, as is most probable, either or both wires fail to reverse upon the second point, he must then, by estimation, remove half the error by the screws at C (page 150), at right angles with the wire sought to be corrected, remembering at the same time that, on account of the inverting power of the eyepiece, he must move the slide in the direction which apparently increases the error. When both wires in succession have been thus treated, the line of collimation is adjusted on the near object, and the tele-

scope again brought upon the most distant point ; here the tube is again revolved, the reversion of the wires upon the object once more tested, and the correction, if necessary, made in the same manner.

He proceeds thus until the wires will reverse upon both objects in succession ; the line of collimation will then be in adjustment at these and all intermediate points, and by bringing the screw-heads, in the course of the operation, to a firm bearing upon the washers beneath them, the adjustable ring will be fastened so as to need no further adjustment for many years.

When this has been completed, the thin brass ferule is screwed over the outside ring, concealing the screw-heads and avoiding the danger of their disturbance by an inexperienced operator.

In making this adjustment, it is always best to bring the wires into the center of the field of view by moving the little screws, A A, (page 150), working in the centering-ring of the eyepiece tube.

Should the engineer desire to make the adjustment of the object-glass slide, it will be necessary to remove the level-tube in order that the small screw immediately above its scale may be operated upon with the screw-driver.

The adjustments which are common to all Y-Levels, and with which the Engineer should be familiar, are :

1. To adjust the line of collimation, or in other words, to bring the cross-wires into the optical axis, so that their point of intersection will remain on any given point during an entire revolution of the telescope.

2. To bring the level-bubble parallel with the bearings of the Y-rings or with the longitudinal axis of the telescope.

3. To adjust the Ys, or to bring the bubble into a position at right angles with the vertical axis of the instrument.

To adjust the line of collimation, set the tripod firmly, remove the Y-pins from the clips so as to allow the telescope to turn freely, clamp the instrument

LINE OF COLLIMATION. to the leveling-head, and by the leveling and tangent screws bring either of the wires upon the clearly marked edge of some object, distant from one hundred to five hundred feet. Then with the hand carefully rotate the telescope half-way around, so that the position of the same wire is compared with the object selected.

Should it be found above or below, bring it half-way back by the capstan-head screws at right angles with it, always remembering the inverting property of the eyepiece; now bring the wire again upon the object and repeat the first operation until it will reverse correctly. Proceed in the same manner with the other wire until the adjustment is completed.

Should both wires be much out, it will be well to bring both nearly correct before either is entirely adjusted.

When this is effected, unscrew the covering of the eyepiece centering-screws, shown in the sectional view at A A, page 150, and move each pair in succession with a screw-driver until the wires are brought into the center of the field of view. The inverting property of the eyepiece does not affect this operation, and the screws are moved directly.

To test the correctness of the centering, rotate the telescope, and observe whether it appears to shift the position of an object. Should any movement be perceived, the centering is not perfectly effected. In all telescopes the line of collimation depends upon the relation of the cross-wires and

object-glass ; and therefore the movement of the eyepiece does not affect the adjustment of the wires in any respect.

When the centering has once been effected it remains permanent, the cover being screwed on again to conceal and protect it from derangement at the hands of the curious and inexperienced operator.

To adjust the level-bubble, clamp the **LEVEL-VIAL.** instrument over either pair of leveling-screws, and bring the bubble into the middle of the tube.

Now turn the telescope in the Ys, so as to bring the level-tube on one side of the middle of the bar. Should the bubble run to the end, it would show that the vertical plane passing through the middle of the bubble was not parallel to that drawn through the axis of the telescope rings.

To correct the error, bring the bubble, by estimation, half-way back with the capstan-head screws on each side of the level-holder, placed usually at the object-glass end of the tube.

Again bring the level-tube over the middle of the bar and the bubble to the middle, turn the level to either side, and, if necessary, repeat the correction until the bubble will keep its position when the tube is turned half an inch or more to either side of the middle of the bar.

The necessity for this operation arises from the fact that, when the telescope is reversed end for end in the Ys in the other and principal adjustment of the bubble, we are not certain of placing the level-tube in the same vertical plane ; and therefore it would be almost impossible to effect the adjustment without a lateral correction.

Having now, in great measure, removed the preparatory difficulties, we proceed to make the level-tube parallel with the bearings of the Y-rings.

To do this, bring the bubble into the middle with the leveling-screws, and then, without jarring the instrument, take the telescope out of the Ys and reverse it end for end. Should the bubble run to either end, lower that end, or, what is equivalent, raise the other by turning the adjusting-nuts on one end of the level until, by estimation, half the correction is made; again bring the bubble into the middle by the leveling-screws, and repeat the whole operation until the reversion can be made without causing any change in the bubble.

It would be well to test the lateral adjustment and make such correction as may be necessary in that, before the horizontal adjustment is entirely completed.

To adjust the Ys: Having made the previous adjustments, it remains now to bring the level into
YS. position at right angles with the vertical axis, so that the bubble will remain in the middle during an entire revolution of the instrument.

To do this, bring the level-tube directly over the middle of the bar and clamp the telescope in the Ys, placing it as before, over two of the leveling-screws, unclamp the socket, level the bubble, and turn the instrument half-way around, so that the level-bar may occupy the reverse position with respect to the leveling-screws beneath.

Should the bubble run to either end, bring it half-way back by the Y-nuts on either end of the bar; then move the telescope over the other set of leveling-screws, bring the bubble again into the middle, and proceed as above described, changing to each pair of screws successively until the adjustment is very nearly perfected, when it may be completed over a single pair.

The object of this approximate adjustment is to bring the upper parallel plate of the tripod head into a position

as nearly horizontal as possible, in order that no essential error may arise in case the level, when reversed, is not brought precisely to its former position. When the level has been thus completely adjusted, if the instrument is properly made and the socket well fitted, the bubble will reverse over each pair of screws in any position.

Should the Engineer be unable to make it work correctly, he should examine the outside socket carefully to see that it is set securely in the main socket, and also notice that the clamp does not bear upon the ring which it encircles.

When these are correct, and the error is still manifested, it will probably be found in the imperfection of the interior spindle.

After the adjustments of the level have been made, and the bubble remains in the middle in any position of the socket, the Engineer should turn the telescope in the Ys until the pin on the clip of the Y will enter the little recess in the ring to which it is fitted, and by which is insured the horizontal position of the cross-wire.

When the pin is in its place the horizontal wire may be applied to any level line, and in case it should not be parallel with it, two of the cross-wire screws that are at right angles with each other may be loosened and, by the screws outside, the cross-wire ring turned until the wire is horizontal; the line of collimation must then be corrected again and the adjustments of the Level will be complete.

TO USE THE LEVEL.

When using the instrument, the legs of the tripod must be set firmly into the ground; the bubble should then be brought over each pair of leveling-screws successively and leveled in each position, any correction being made in the adjustments which may appear necessary.

Care should be taken to bring the wires precisely in focus, and the object distinctly in view, so that all errors of parallax may be avoided. This error is seen when the eye of an observer is moved to either side of the center of the eyepiece of a telescope, in which the foci of the eyepiece and object-glass are not brought precisely upon the cross-wires and object; in such a case the wires will appear to move over the surface and the observation will be liable to inaccuracy.

In all instances, the wires and object should be brought into view so perfectly that the cross-wires will appear to be fastened to the surface, and will remain in that position however the eye is moved.

In running levels it is best, wherever possible, that equal fore-sights and back-sights should be taken, so as to avoid any error arising from the curvature of the earth.

If the socket of the instrument becomes so firmly set in the leveling-head as to be difficult of removal in the ordinary way, the Engineer should place the palm of his hand under the Y-nuts at each end of the bar and give a sudden upward blow to the bar, taking care also to hold his hands so as to grasp it the moment it is free.

If there is any roughness in the movement of the object-glass slide, it may be looked for in three places:

1. Remove the four little screws that attach the pinion-strap to the telescope. See that the pinion turns freely in its socket; if it does not, then there is dirt in the bearing that is cutting its surface. Remove the nut at the end of the pinion-rod and knock the pinion out of its head with a block of wood. The scratched surface can be rubbed smooth with the back of a knife-blade. Put a little tallow on the bearings and replace the parts.

2. While the pinion is out, see that the slide moves freely in or out. If it scratches, rub it smooth.

3. If the pinion movement and slide are found in good order, the trouble may be found on the slide of the slot opposite the rack, on the edge which bears upon the back of the pinion-socket. Rub it smooth and apply a little tallow.

We have introduced in the object-glass slides of all our telescopes, as well as in the pinion-sockets, an anti-friction bearing which, after a trial of several years, has proved to be a complete remedy for the abrasion or fretting of the surface above mentioned.

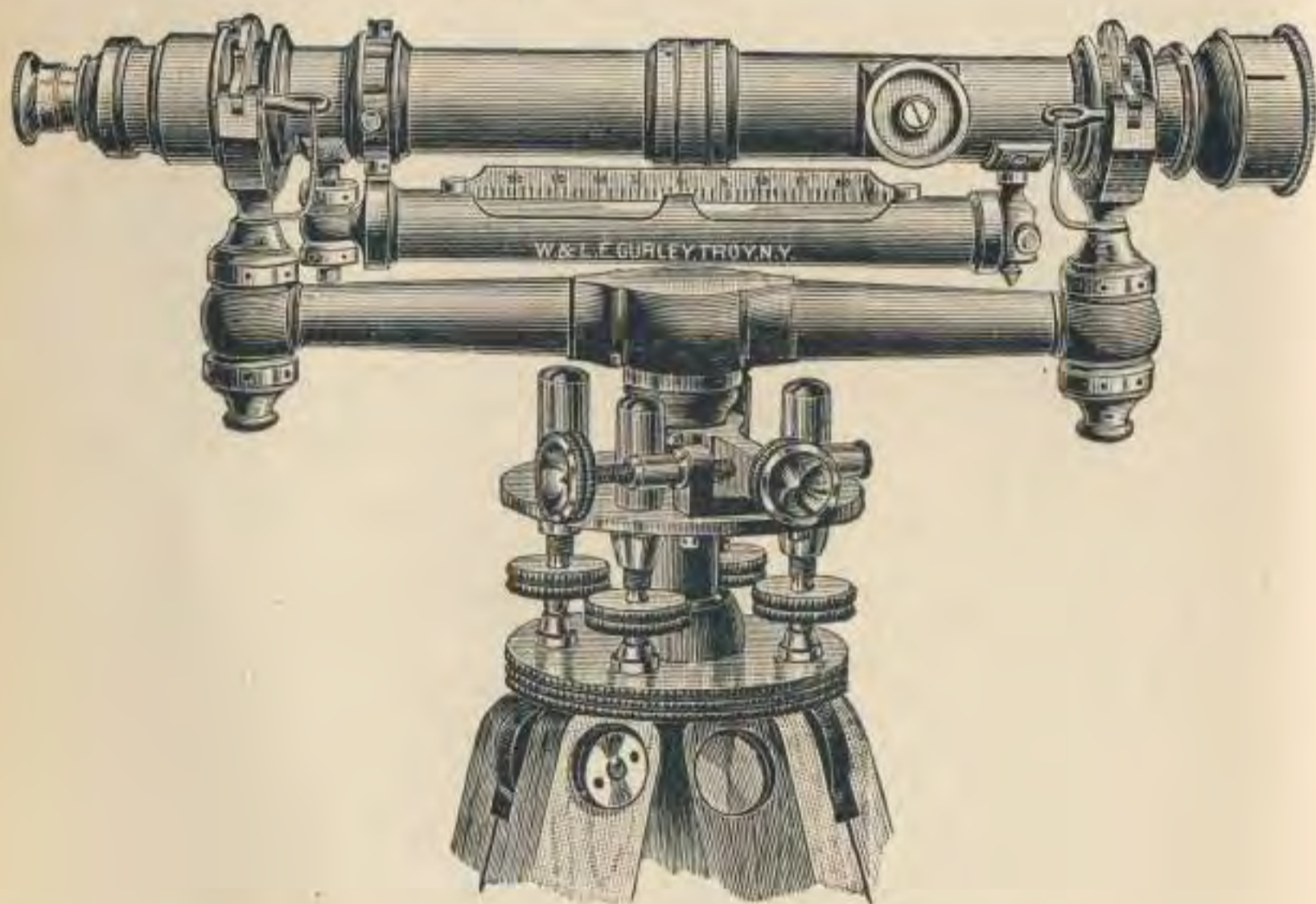

No. 378.

15-INCH Y-LEVEL. Price as shown, with tripod, \$90.00.

Our fifteen-inch Level, as shown, has the same arrangement of sockets, tripod, etc., as the larger Levels, but has no pinion movement to the eyepiece. The shade to the object-glass is removable. The leveling-head remains attached to the

spindle, and is packed with it in the box. The instrument is also somewhat smaller and lighter than the other sizes.

SIZE AND WEIGHT. The average weight of the different sizes of our Y-Levels, exclusive of the tripod, is about as follows :

22-inch telescope, with leveling-head.....	14 $\frac{1}{4}$ lbs.
20-inch " " " "	13 $\frac{1}{2}$ lbs.
18-inch " " " "	13 $\frac{1}{4}$ lbs.
15-inch " " " "	11 $\frac{1}{4}$ lbs.
Architects' Level, " "	6 $\frac{1}{2}$ lbs.

THE ARCHITECTS' LEVEL.

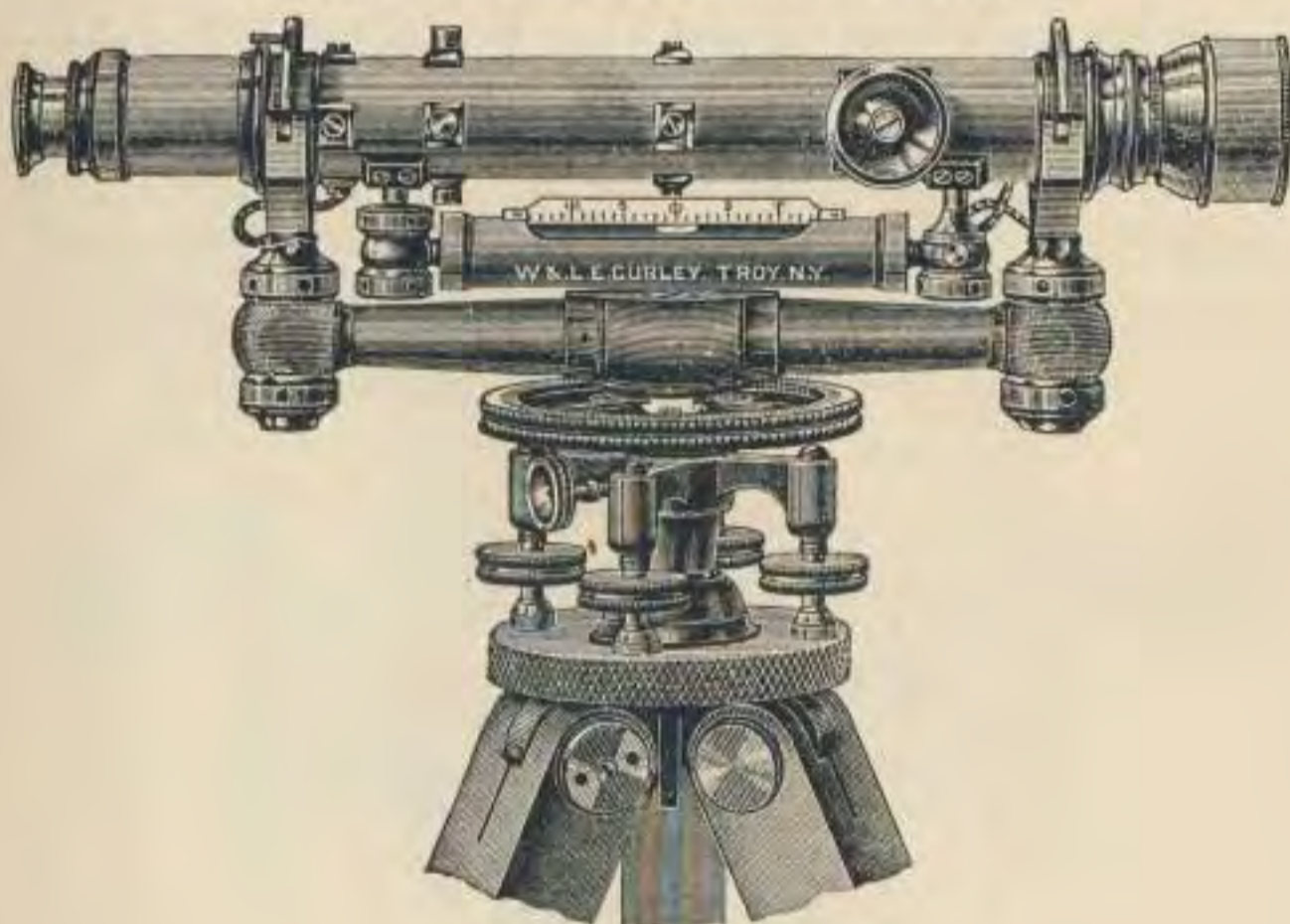

No. 380.

Price as shown, with tripod, \$50.00.

The figure represents a Level, introduced by us in 1874, which is very largely used by Architects, Builders and Millwrights, as well as by Engineers and Surveyors, in the grading of streets, drains and sewers.

The instrument has a telescope twelve inches in length, furnished with rings and Ys like the larger Levels, and adjusted in the same manner.

The leveling-head has the ordinary screws and clamp to the spindle, but no tangent movement; it has also a horizontal circle three inches in diameter, fitted to the upper end of the socket and turning readily upon it; the circle is graduated to degrees, figured from 0 to 90 each way, and is read to five minutes by a vernier which is fixed to the spindle.

The telescope is directed to any object by hand, the spindle turning readily in its socket; but it can be clamped in any position by the clamp-screw shown under the circle.

The instrument is placed either upon a light tripod as shown, or on a small triangular plate, called a "trivet," having three sharp steel points by which it is firmly set upon any surface of wood or stone; both tripod and trivet are furnished with the Level. A short piece of tube called a shade is also supplied, to put on over the object-glass to protect it from the glare of the sun.

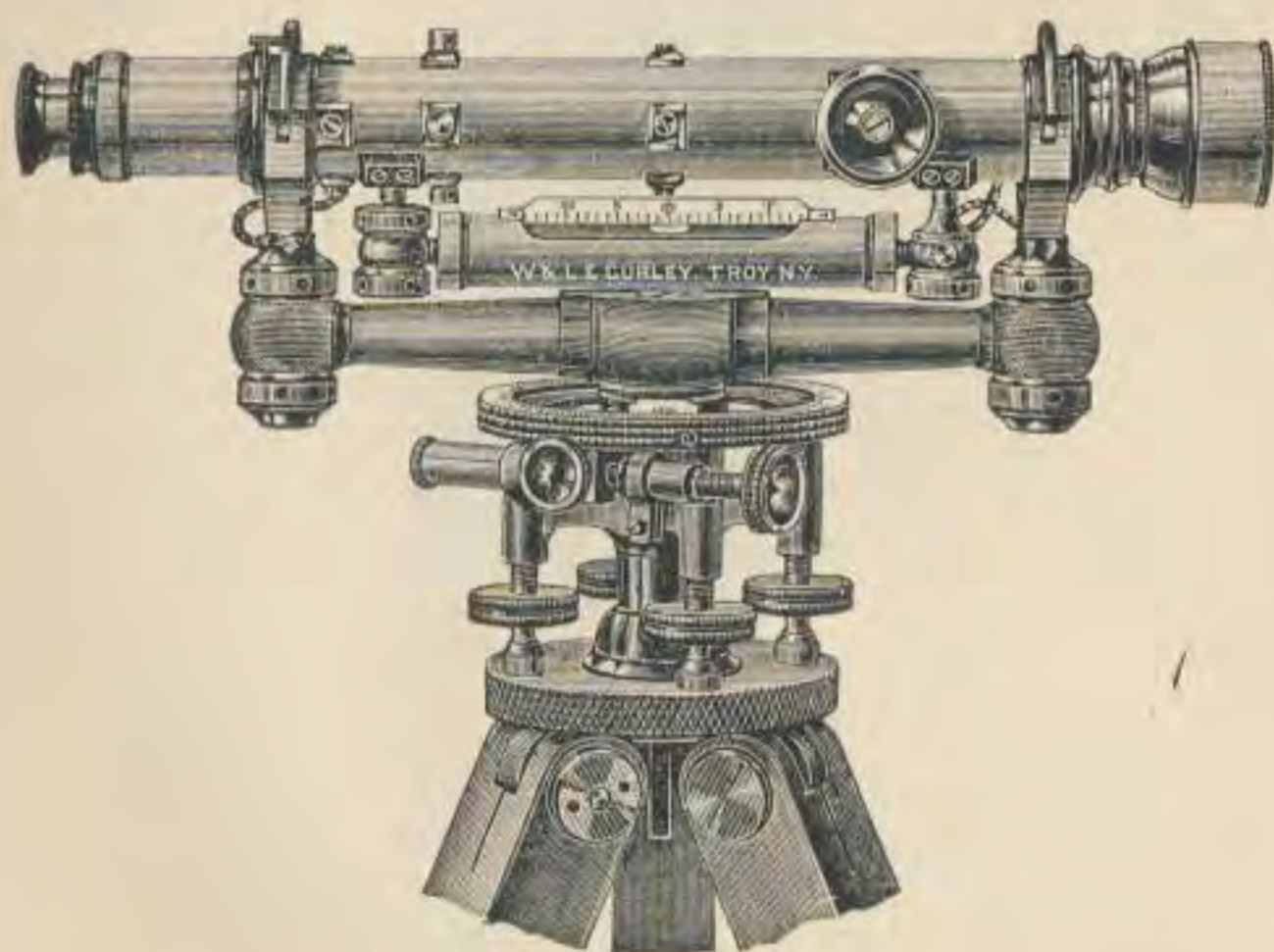

No. 381.

Price as shown, with clamp and tangent to spindle, \$65.00.

We add the Architects' Level, when desired, a clamp and tangent movement to the leveling-head, thus enabling the instrument to be clamped more securely, and a movement in a horizontal plane to be made more accurately. When thus fitted the Architects' Level is sold for \$65.00.

The adjustments of the Architects' Level are made exactly as described in our account of the
ADJUSTMENTS. larger Levels. They are not liable to derangement, and will ordinarily require but little attention.

TO USE THE ARCHITECTS' LEVEL.

The instrument should be set up firmly upon the tripod or trivet, and in a position as nearly level as practicable, the telescope placed over either pair of leveling-screws, and the bubble brought into the middle by turning the opposite screws with the thumb and forefinger of each hand, the thumbs being both turned in or out as may be needed, and both screws brought to a bearing in the little cups underneath. Having brought the bubble into the middle of the vial, turn the telescope over the other pair of screws, and repeat the same operation.

The instrument having thus been carefully leveled, bring the eyepiece and object-glass into focus upon the object as before described, and the horizontal cross-wire will give any number of points required, which will all be in the same level plane.

A strip of board held erect will answer as a rod, and a line in pencil drawn across it at the part cut by the horizontal wire will give the height of the starting-point; and any different points on the rod, either above or below that indicated by the cross-wire, will show the difference in height of the various points assumed, as compared with the starting-point.

In laying off angles with the Level, the bubbles should first be brought into the middle as before described, and **LAYING OFF ANGLES.** the vertical cross-wire made to cut the object or line from which the angle is to be taken. Then, the spindle being clamped by the little milled head screw under the circle, the circle is turned around by hand until the zero-lines of both circle and vernier are made to coincide; then loosen the clamp-screw, turn the telescope to the point desired, and the angle between the two points will be read off on the circle.

The point underneath the Level is easily indicated by the point of the plummet suspended from the tripod.

It will be understood that, by the use of the vernier, angles can be read on the circle to five minutes of a degree, but ordinarily only even angles will be taken and only the middle line of the vernier will be used.

In many situations, after the walls of a building have been carried up to any required height, it becomes difficult

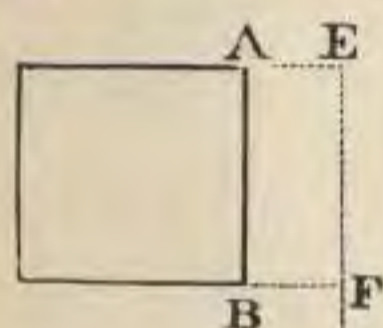

to set up the tripod, and in this case the level is screwed upon the trivet, which can be set upon the wall or a piece of board tacked to the building, or indeed upon any surface nearly level and not less than six inches square.



To illustrate the value of this instrument in laying out the sites of buildings, suppose it is desired to erect a building, C D, at right angles with a building, A B, and at a given distance from its front.

First set up the Level at E, and carefully center the bubble, the point of the plummet below indicating the required distance of the side of the

new building from the front, A B. Measure the same distance at the other corner of A B, and, having erected the rod, sight upon it with the telescope and clamp to the spindle.

Now carry the rod the required distance from B, and move it from side to side until it is again in line with the telescope, as at C.

Remove the instrument, and having carefully set it over the point, C, by the plummet and brought the bubble into the middle as before, set the telescope again upon the rod placed at E or F, and clamp to the spindle. Bring the zeros of the circle and vernier to coincide, unclamp, and turn the vernier to ninety degrees; this will give a point, D, at any required distance from C, and C D will be the side of the proposed building. The side, C G, is determined by turning the telescope around until the vernier is in line with the other zero of the circle, and thus the corner, C, and the two sides, C D and C G, are at once set off, and the remaining corner, H, easily ascertained by making D H and G H equal to C G and C D respectively.

Other uses of the level, as the setting of floor-timbers, of window and door sills, the leveling of floors, etc., will readily occur to one who has been engaged in building, where it is of great advantage.

To the Millwright such a Level is almost indispensable in the lining and leveling of shafting, the ascertaining of the fall of water obtainable, and in determining the overflow of land by a mill-pond.

The farmer will find it of value in laying out drains, determining their location, ascertaining the height of springs, and similar work.

This Level has become widely known, and its extreme cheapness, simplicity and excellence have created a great demand for it.

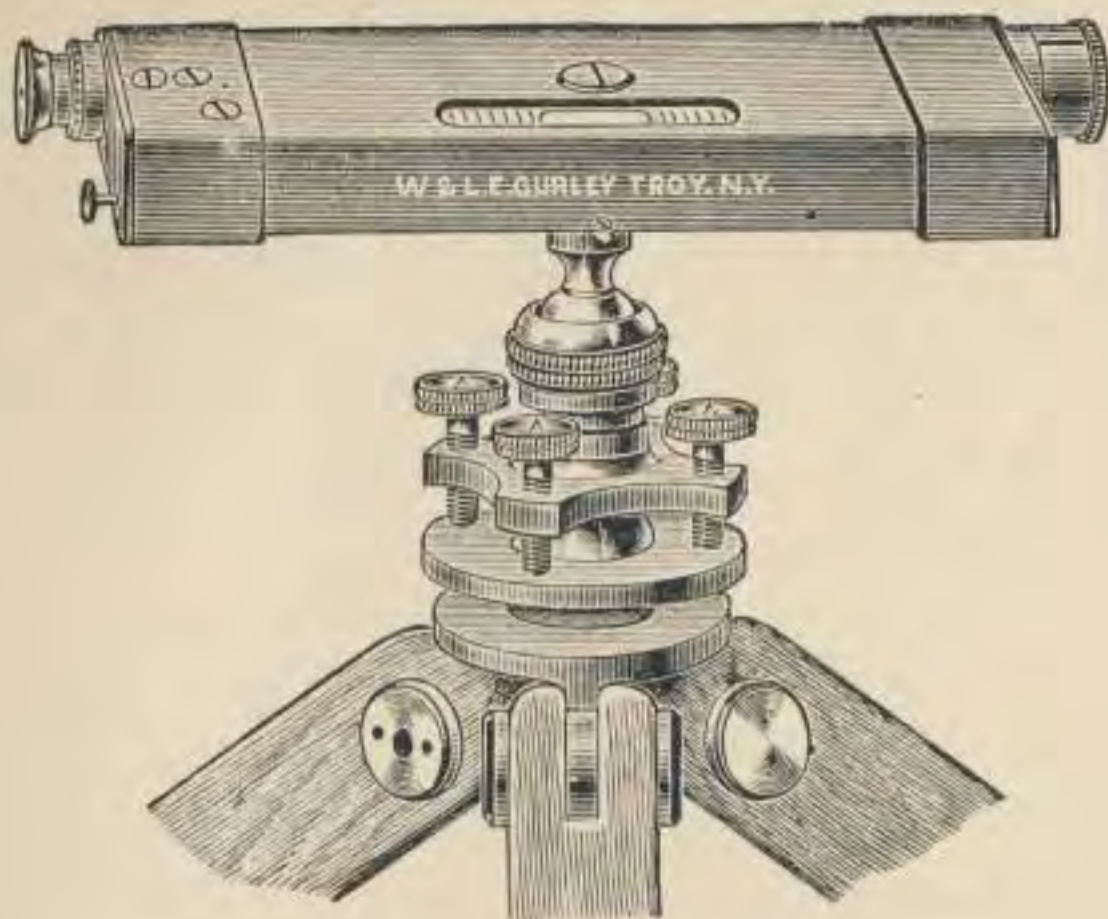
**No. 387.**

Price as shown, \$25.00.

THE DRAINAGE LEVEL. (New Pattern.)

Figure No. 387 represents a Level combining the extremes of simplicity and compactness with real efficiency, and at a very moderate cost. The telescope is about nine inches long, and is made especially for this instrument, achromatic, of low but sufficient power, and good light and definition. The cross-wires are fixed in the eyepiece so that they are not easily disturbed. The level, telescope and socket are enclosed and secured in a strong outside case of brass, about seven and one-half inches long, two and one-quarter inches wide, and one and one-half inches high.

The ends of the case are thickened and made parallel each to each, on the upper and under sides.

A ball attachment screws into a spindle that is within the case, and by which it is made approximately level, and then precisely so by the leveling-screws as shown.

When desired, the leveling-head can be dispensed with, and the instrument leveled by the ball alone.

A Compass with three-inch needle is added to the Drainage Level, when desired. This is fitted securely to the upper surface of the case and can be removed at pleasure; and while it does not interfere in any way with the reading of the level-vial, it furnishes a ready means of determining the bearing of lines or of measuring angles by the needle.



This Level is adjusted almost as simply as an ordinary Masons' or Builders' Level: The spirit-level, by reversing

ADJUSTMENTS. from end to end on the lower faces of the case, and making necessary corrections by the screws at the eyepiece end, marked "L" on opposite faces and in line with the level-tube; the telescope, by applying the opposite faces to the same surface, and bringing the telescope cross-wires by two screws marked "T," one on each face, so as to cut the same point in both positions of the case. A small block of wood, having a screw-thread that fits the top of the ball attachment, is furnished with the instrument, for use in making the above adjustments when needed. When the ball is screwed firmly to the spindle, and the instrument leveled up, it should remain level when reversed upon its spindle in any direction. If it does not, correct the error by the two screws found on the opposite sides of the case and marked "S." Should the cross-wires be indistinct or out of

focus, unscrew the cap of the eyepiece, and turn the setting of the lens around in either direction until the wires are clearly seen, when the cover may be replaced as before. To clamp the instrument on the spindle, turn the small milled-head screw at the eyepiece end.

To screw the ball attachment to the spindle, press in the spring-catch at the bottom of the case, and the ball can then be easily screwed in.

It will, of course, be understood that these adjustments are always made by the maker, and are not liable to derangement in the ordinary use of the Level.

The advantages of this Level, in the work of the farmer, manufacturer and builder, will be apparent on a simple inspection: drains can be located and leveled, the height of springs ascertained, and the accurate levels of lines of shafting, floor-timbers and sills be determined.

The Architects' Leveling-Rods, hereafter described, are intended for use with this instrument, if desired.

PRICES.

No.		PRICE.
385.	Drainage Level, with staff mountings.....	\$15.00
386.	“ “ with plain tripod.....	20.00
387.	“ “ with tripod and leveling-screws.....	25.00
388.	“ “ with tripod and leveling-screws, and with Compass and clamp-screws.....	30.00

TRIPODS.

LEATHER CASES AND POUCHES.

LEVELING-RODS.

RANGING-POLES.

ROD-LEVEL.

PLANE-TABLES.

CURRENT-METERS.

HAND-LEVELS.

ODOMETERS.

CHAINS.

TAPES.

TRIPODS.

IN THE tripods of all our instruments the upper part of the leg is flattened and slotted to fit closely on each side of a strong tenon projecting from the under side of the tripod head, there being also a strong brass bolt, with large head and thumb-nut on opposite sides of the leg, by which it is held firmly in place.

The tripod head is made of the best bell-metal, the tenons and upper part being cast in one piece and firmly braced together. The legs are round, and taper in each direction towards the head and point.

The point or shoe is a tapering brass ferrule, having an iron end ; it is cemented and firmly riveted to the wood.

The legs of all our tripods are about four feet eight inches long from head to point. We make four sizes of tripods with solid legs, as follows :

The heavy tripod, No. 400, has a metal head four and one-quarter inches in diameter, with mahogany legs one and three-eighths inches in diameter at the top, one and three-quarters at the swell and one and one-eighth at the point. This is used with the Engineers' Transit and with the larger Y-Levels.

The medium sized tripod has a head of the same diameter as the former, and mahogany legs which are one and one-eighth inches in diameter at the top, one and five-eighths at the swell and one and one-sixteenth at the point. This tripod is used with the Surveyors' Transit, the light Engineers' Transit, and the fifteen-inch Level.

The Compass tripod, No. 415, has a head about three inches in diameter, and legs which are about one inch in

diameter at the top, one and three-eighths at the swell and seven-eighths at the bottom.

The legs are usually of cherry, and the tripod is used with the various Compasses and with the Vernier Transit-Compass.

PLAIN TRIPODS.

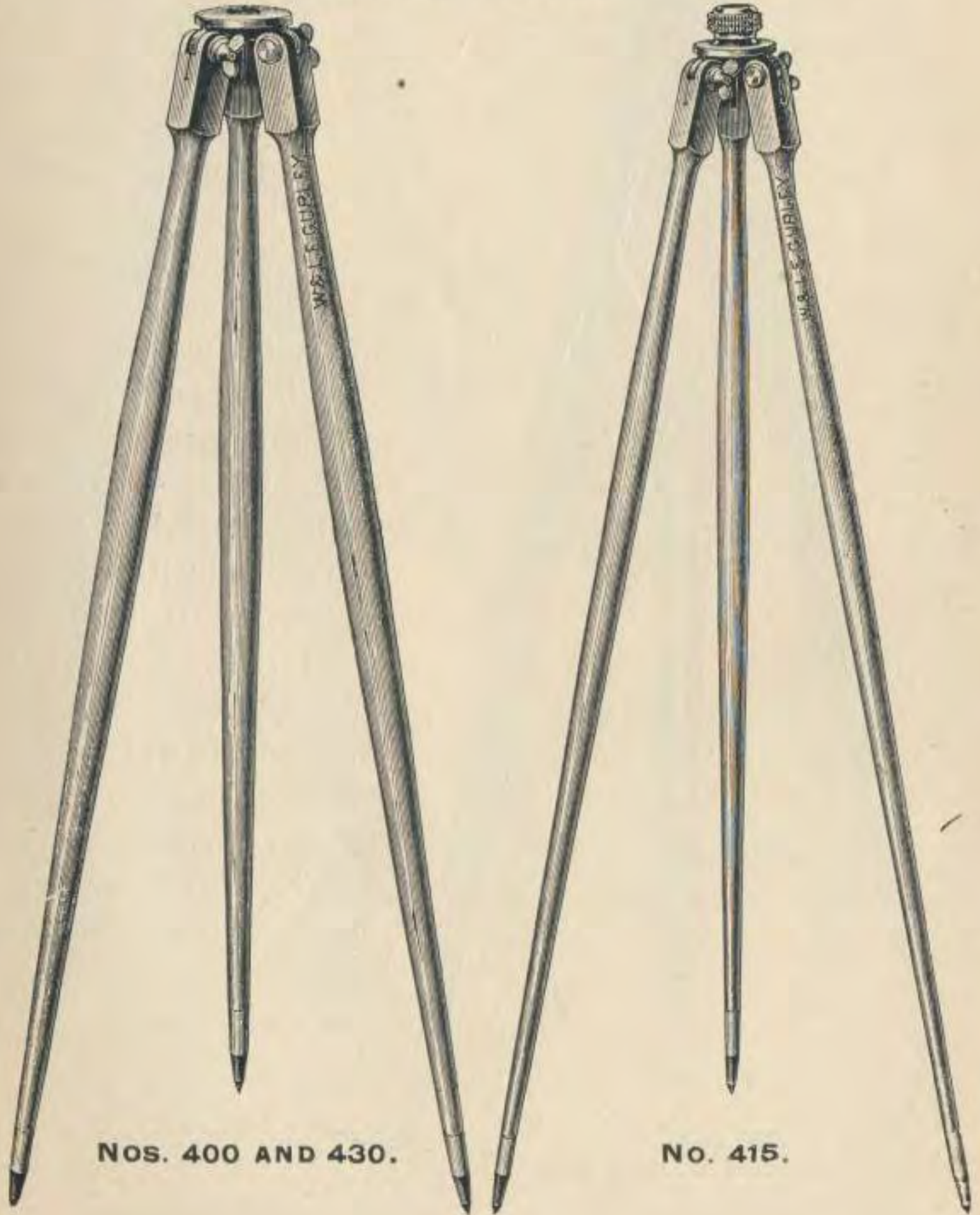

NOS. 400 AND 430.

No. 415.

The Pocket-Compass Tripod is the same style as No. 415, but has smaller heads and legs. The legs are of cherry and are nearly three-quarters of an inch in diameter at the top and bottom, and one and one-eighth at the swell.

SPLIT-LEG TRIPOD.

The improved split-leg tripod is shown in the engraving. The change in form is shown in section at A B.

The legs are of straight-grained ash, and by the new form stiffness and strength are gained with reduced weight and greater comfort in carrying. We are confident that Engineers will regard these changes as great improvements.

We make several sizes of this tripod, to use with Transits, Levels and Compasses.

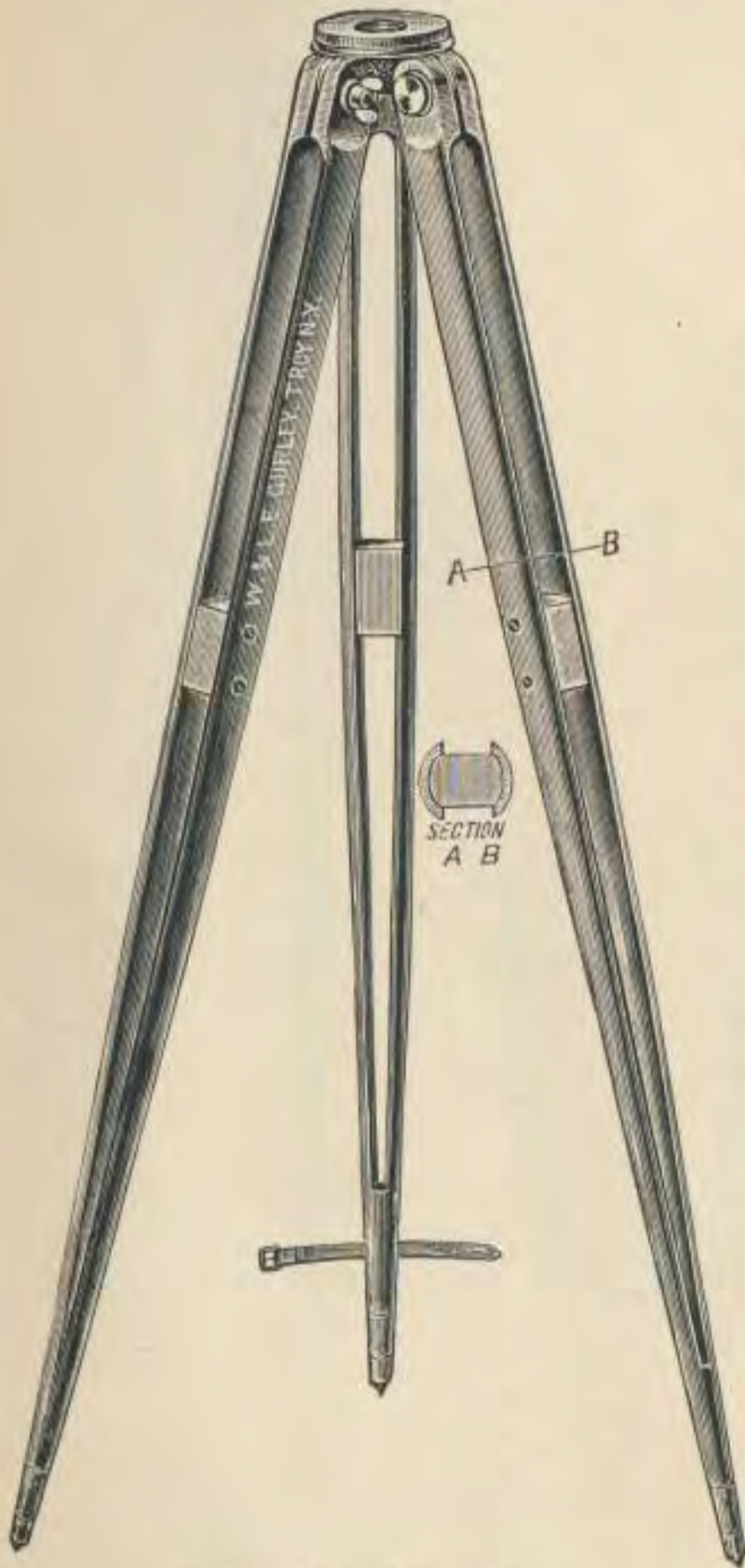

NOS. 405 AND 435.

EXTENSION TRIPOD.

In No. 410 is shown a decided improvement on the old pattern of extension tripod, which has proved so popular. This new tripod is stronger, more rigid and weighs less than the old form.

The difference is shown in section at A B. The new tripod can be carried with more comfort than the old, and the shape of the side pieces allows the middle piece to be clamped firmly with the two bands and screws, while slight changes in length can be made by twisting the middle piece up or down. The legs are of maple, and are clamped to the tripod head with thumb-nuts.

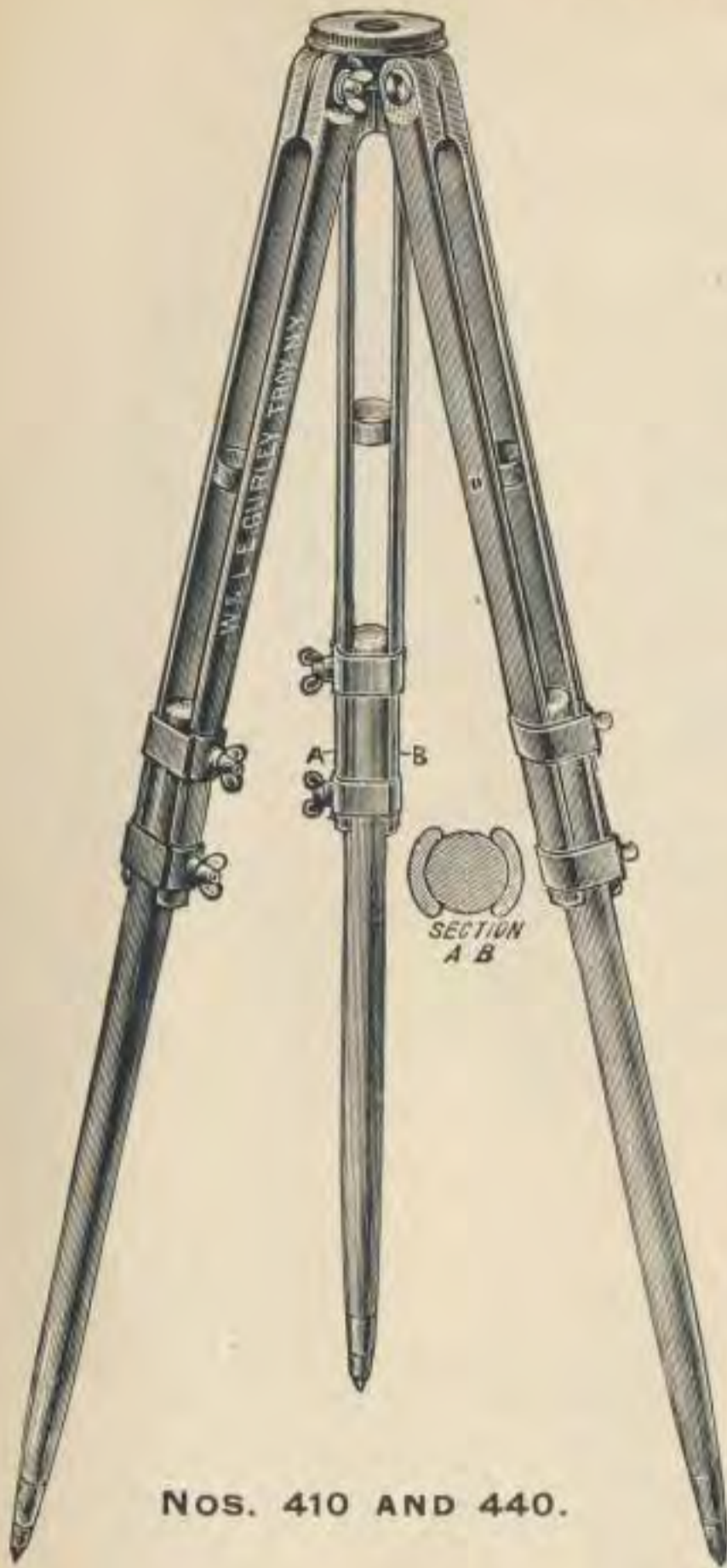

NOS. 410 AND 440.

We make several sizes of extension tripods. The large size is used with the large Transits and Levels, and the medium size with the Mountain Transit. A smaller size is used with the smaller Transits, Architects' Levels and large Compasses, and the smallest size is used with the various Pocket-Compasses.

NOTE.—For prices of plain, split-leg and extension tripods, see pages 261 and 262 of the Price-List.

LEATHER CASES AND POUCHES.

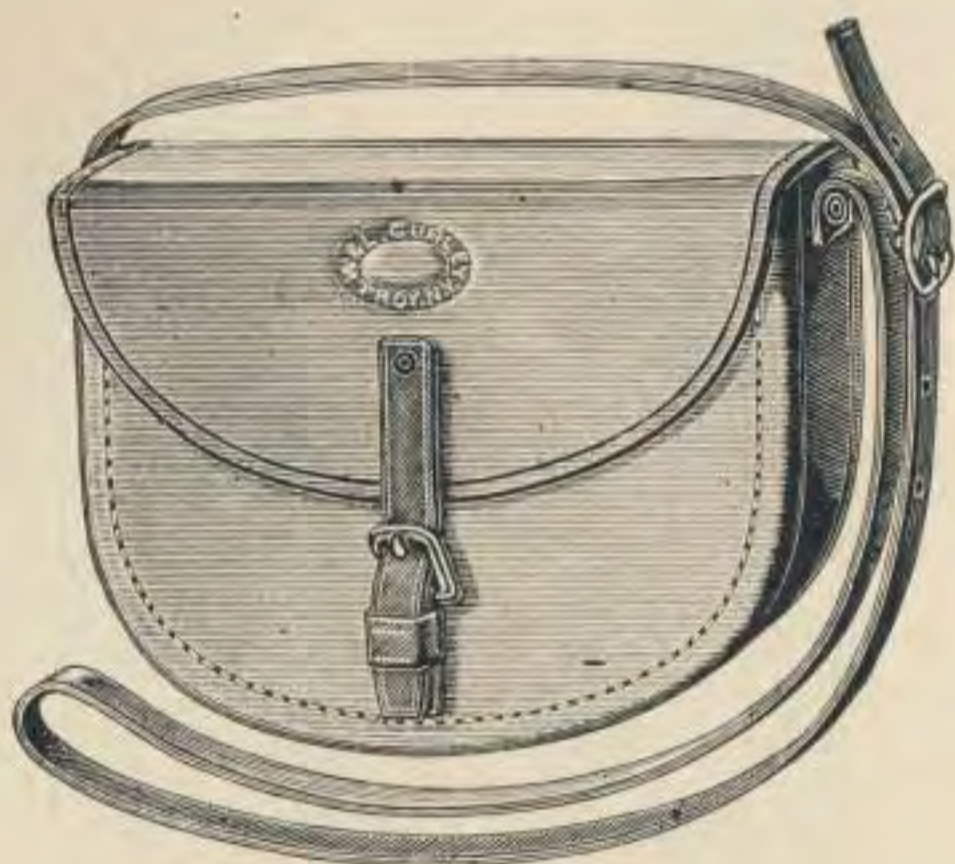

No. 490.

We have in our establishment the best facilities for making all kinds of leather work to order, and can promptly furnish anything in the line of cases or pouches for surveying-instruments.

The small pouch as shown in the cut furnishes a very convenient method for carrying small Pocket-Compasses without telescopes, as Nos. 288-350.

These pouches are strongly made, finished with adjustable sling strap, and are so arranged as to hold the Compass and its mountings firmly and protect them from any injury in transportation. The wooden box in which the small Compasses are packed is omitted when the leather *pouch* is used. The leather *cases*, however, are fitted to hold the wooden box containing the instrument, and are used with any Transit, Level or Compass.

NOTE.—For prices of leather cases and pouches, see page 263 of the Price-List.

LEVELING-RODS.

WE GIVE on the following pages cuts and descriptions of the leveling-rods commonly used by American Engineers and Surveyors, which are manufactured by us in large quantities and kept constantly in stock.

Our facilities for the manufacture of leveling-rods have for many years surpassed those of all other makers. The greatest care is exercised in the preparation and seasoning of the wood, special appliances and machinery for the work have been constructed at great cost, and in point of finish and accuracy our rods are unexcelled.

For many years we have made to order special rods, to **SPECIAL** designs furnished, which have been used in the **RODS.** most critical work with perfect satisfaction. We are prepared to make rods of any design to order.

THE PHILADELPHIA ROD.

(No. 500.)

This rod is made in two parts, each about three-quarters of an inch thick by one and one-half inches wide and seven and three-tenths feet long, the parts connected by two metal sleeves, the upper one of which has a clamp-screw for fastening the two parts together when the rod is raised for a higher reading than seven feet.

Both sides of the back strip and one side of the front are recessed one-sixteenth of an inch below the edges. These surfaces are painted white, graduated into feet, tenths and hundredths of a foot, and the feet and tenths figured.

The graduations and figures are slightly impressed on the recessed surfaces, thus increasing their durability.

The edges of the rod and the corners of the brass mountings are rounded, for ease in handling.

The front piece reads from the bottom upward to seven feet, the foot figures being red and the tenth figures black. When the rod is extended to full length the front surface of the rear half reads from seven to thirteen feet, and the whole front of the rod is figured continuously and becomes a self-reading rod thirteen feet long, reading to hundredths of a foot.

The back surface of the rear half is figured from seven to thirteen feet, reading from the top down; it has also a scale by which the rod is read to hundredths and half-hundredths of a foot as it is extended. The target is round, made of brass raised on the perimeter to increase its strength, and is painted in white and red quadrants; it has also a scale on its chamfered edge, reading to half-hundredths of a foot.

When a level of less than seven feet is desired the target is moved up or down the front surface, the rod being closed and clamped; but when a greater height is required the target is fixed at seven feet and the rear half extended, the scale on the back giving the readings like those of the target to half-hundredths of a foot.

NO. 500. PHILADELPHIA ROD. Price, \$14.00.



THE BOSTON ROD.

(No. 503.)

This rod is formed of two pieces, each about six feet long, sliding easily by each other in either direction.

One side is furnished with a clamping piece and screw, with a small vernier at each end; the other or front piece carries the target, and has on each side an inlaid strip upon which graduations of feet, tenths and hundredths are marked and figured.

The target is a disk of brass raised on its perimeter, fastened on the front half, and is painted red and white, having its middle line just three-tenths of a foot from the end of the rod.

Each tenth of the rod is figured decimally in three figures, or to hundredths of a foot, and by the verniers is read to thousandths.

The target being fixed, when any height is taken above six feet, the rod is changed end for end and the graduations read by the other vernier, the height to which the rod can be extended being a little over eleven feet.

This rod is very convenient on account of its lightness, but the parts are too frail to endure the rough usage of this country; and American Engineers generally prefer other rods which are heavier and more substantial.



No. 503. BOSTON ROD, Price, \$14.00.

THE TROY ROD.

(No. 504.)

The cut represents another form of the sliding leveling-rod, called the Troy Rod. This is a self-reading rod up to six feet, or it can be read by a vernier on the rear piece to thousandths of a foot, as usual.

It has two targets as shown, both fastened to the front half of the rod, the lower one having its middle line just three-tenths of a foot above the end, and the other target exactly six feet above the lower.

There is a clamping piece with screw on the back of the rod, below the upper target, by which the two parts are clamped together when desired.

The face of the front piece is recessed like that of the Philadelphia rod, painted white, graduated to feet and hundredths, and figured as represented.

The side of the front half is graduated to feet and hundredths, read by a vernier on the top of the rear half to thousandths, and figured from the top downwards, beginning with three-tenths, that being the height of the middle line of the lower target.

When a level of less than six feet is taken on the rod the observation is made by the lower target, and the reading is direct as given on the side; but when a greater height is taken the upper target is sighted upon, and six feet added to the reading on the side in every instance, a



No. 504. TROY ROD. Price, \$10.00.



reading up to twelve feet being thus readily obtained.

THE NEW YORK ROD.

(No. 505.)

This rod, which is shown in the engraving as cut in two, so that the ends may be exhibited, is made in two parts, the pieces sliding one from the other, the same end being always held on the ground, and the graduations starting from that point.

The graduations are made to tenths and hundredths of a foot, the tenth figures being black, and the feet marked with a large red figure.

The front surface, on which the target moves, reads to six and one-half feet on the two-part rods. When a greater height is required, the horizontal line of the target is fixed at the highest graduation, and the upper half of the rod carrying the target is moved out of the lower, the reading being now obtained by a vernier on the graduated side, up to an elevation of twelve feet.

The target is round, made of brass with a raised rim to strengthen it and to protect the paint from being defaced.

The target is arranged with an improved clamp, which can be so adjusted as to regulate the friction on the rod, enabling the target to be easily moved up and down, and to be clamped with a slight turn of the binding-screw.

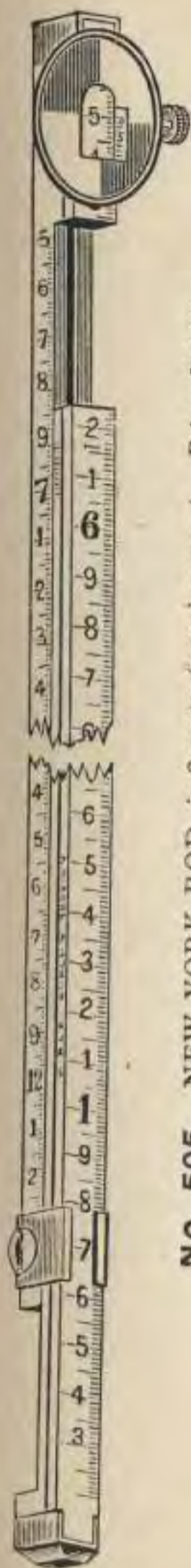

No. 505. NEW YORK ROD, in 2 parts (usual pattern). Price, \$14.00.



No. 507. NEW YORK ROD, in 3 parts. Price, \$18.00.
No. 508. NEW YORK ROD, in 4 parts. Price, 20.00.



The face of the target is graduated into quadrants by horizontal and vertical diameters, the quadrants being painted alternately white and red, or sometimes white and black.

The opening in the face of the target is nearly two-tenths of a foot long, so that in any position a figure noting a tenth of a foot can be seen on the surface of the rod.

The right edge of the opening is chamfered, and graduated into ten equal spaces corresponding with nine hundredths on the rod. The graduations start from the horizontal line which separates the colors of the face.

The vernier, like that on the side of the rod, reads to thousandths of a foot. The rod is fitted with the improved clamp.

THE NEW YORK ROD.

In three or four parts. (Nos. 507 and 508.)

(PATENTED.)

In this rod, as shown, a third or fourth piece is added, giving a rod of a greater length, and at the same time making it more compact and portable.

The graduations, verniers and readings are the same as those of the rod in two parts.

The three-part rod allows a reading of twelve and one-half feet, and when closed is five feet long.

The four-part rod when closed is five feet long, but it can be extended to sixteen feet.

THE ARCHITECTS' ROD.

(Nos. 510 and 511.)

This is a very light and simple sliding rod in two equal parts, each seven-eighths of an inch square, and when closed the rod is about five feet six inches long.

As shown, the front half is graduated on two sides to feet, tenths and hundredths, reading by verniers on the target and side to thousandths of a foot.

The target is similar to those of the rods already described, and it moves on the closed rod when levels of less than five and four-tenths feet are to be taken.

When a greater height is needed, the target is fixed at the highest graduation, the front half carried above the rear part and clamped by the clamp-screw at any point desired, the height up to ten feet being now read off by the vernier on the lower half.

This rod is adapted for use with any Level, and is so light and efficient that it has been received with favor. It is, however, generally used with the Architects' and Drainage Levels.

When it is designed for Architects' use the graduations are in feet, inches and sixteenths, and no vernier is required.



No. 511. ARCHITECTS' ROD. Price, \$6.00.

THE MACHINISTS' ROD.

(No. 512.)

The Machinists' Rod is made in one piece with a cross-section about seven-eighths of an inch square and a length of six and one-half feet, and is graduated on one face to feet, inches and sixteenths. At one end and attached to the rod with a swivel is a large hook by which the rod may be hung from a shaft. The target is painted red with broad white lines crossing the center and is fitted with candle-holder. This rod is designed especially for use in leveling shafting in factories and in conjunction with the Architects' Level will be found most serviceable.

THE TELEMETER ROD.

(No. 513.)

The Telemeter, or Stadia, Rod is formed of two pieces of pine, each three and one-half inches in width and six feet long. The inner surfaces of the rod are recessed to protect the graduated surface, and painted white, with graduations in black to feet, tenths and hundredths, the feet figured in red and the tenths in black. The two pieces are connected by strong brass hinges and folded in transportation. When in use they are opened, laid flat and held firmly in line

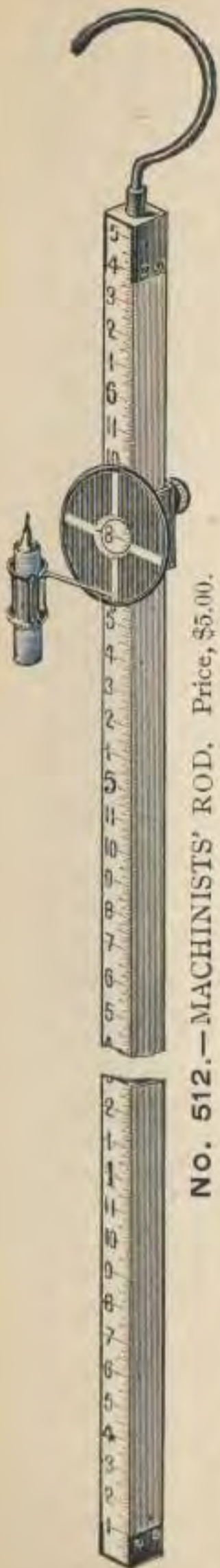

No. 512.—MACHINISTS' ROD. Price, \$5.00.



No. 513.—TELEMETER OR STADIA ROD. Price, \$12.00.

by a steel pin which passes through sockets at the back of the hinges. The rod tapers toward the top from a thickness at the bottom of one and one-eighth inches. This is a self-reading rod, and is often used in connection with the stadia to ascertain distances by simple observation, in the same manner as the Philadelphia rod already described. The price is \$12.00.

THE TELESCOPIC ROD.

(No. 515.)

This rod is made so that the two smaller upper parts slide out of a larger and lower part which answers as a case. When closed the rod is five feet long, and it extends to fourteen feet. It is graduated on a recessed face to feet, tenths and hundredths, the graduations being painted and figured like those of the Philadelphia and Telemeter rods.



No. 515. TELESCOPIC ROD. Price, \$24.00.



THE CROSS-SECTION ROD.

(No. 516.)

This rod is made of well-seasoned pine, and is ten feet long and one and one-half inches square at the ends; it is about four inches thick in the middle, where there is an opening for the hand, as shown. Both sides are graduated on a recessed white surface, the graduations being painted black like those of a leveling-rod, and figured



No. 516. CROSS-SECTION ROD. Price, \$10.00.

from the same end of the rod. There is also an adjustable spirit-level at each end, one of which is shown in the cut.

PLAIN LEVELING-ROD.

(No. 518.)

A very good self-reading rod is made of seasoned white pine, recessed and graduated on one face like the Philadelphia rod. A rib at the back, extending through the length of the rod, gives great rigidity, while it does not materially increase the weight. The plain leveling-rod is commonly made ten and twelve feet long, but can be made longer, if desired, at an additional cost of about fifty cents per foot.

METRIC RODS.

Besides the usual graduation of leveling-rods into feet and parts of a foot, we graduate them, when desired, into meters, decimeters and centimeters. The scales on the targets and sides of the rods read the centimeters to millimeters on all except the telemeter, telescopic and plain rods, which have no targets and are read only to centimeters. The New York, Troy, Boston and Architects' Metric rods are graduated, when desired, to read by vernier to one-tenth of a millimeter.

LEVELING-POLE.

The leveling-pole, shown in No. 530, is a combination of a plain self-reading rod and a



No. 518. PLAIN LEVELING-ROD. Price, \$6.00.

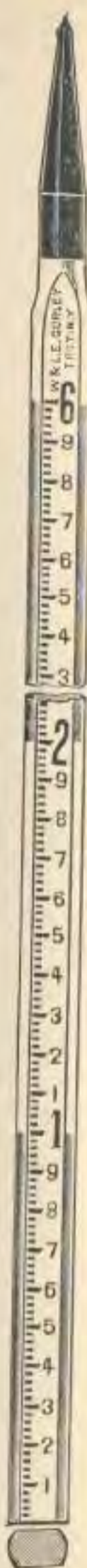

No. 530.

flagpole. It is made with flat face, front and rear, and rounded sides. One face is graduated to feet and hundredths of a foot, while the other face and sides are graduated to feet only and are painted red and white alternately. The pole is made seven and nine feet long, the graduated faces reading to six and eight feet respectively, and when used as a rod is read, as shown in the cut. The prices are \$5.00 and \$6.00.

WOOD AND IRON FLAGSTAFFS.

We make three sizes of the common wood flagstaffs, or ranging-poles. They are octagonal in form, tapering from the bottom to the top, six, eight and ten feet long, and have steel shoes. (See cut No. 534.)

We also make a convenient ranging-pole of an iron tube, eleven-sixteenths of an inch in diameter, hung in gimbals so that it can be readily set over a given point. (See cut No. 539.) Similar iron poles are made without gimbals, six and eight feet long.

These staffs are graduated to feet, and painted alternately red and white.

They are also graduated metrically, when desired, five spaces to each meter.

NOTE.—For prices of Leveling-Rods and Flagstaffs, see pages 264 and 265 of the Price-List.



No. 534.

No. 539.

THE ROD-LEVEL.

(PATENTED.)

No. 545 represents a level for the more accurate plumbing of leveling-rods and ranging-poles. The figures show it when folded for carrying, and also as attached to a rod.

It is held in place by the hand, or can be secured by a string or rubber band to hooks attached to each plate of the level. Its convenience and value have commended it to general favor.

**No. 545. ROD-LEVEL.**

Price, \$3.00.

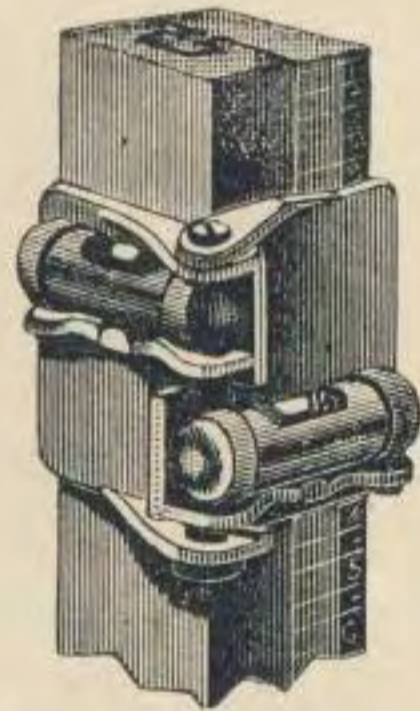

ROD-LEVEL AS APPLIED TO A ROD.

THE PLANE-TABLE.

THE recognized utility of the Plane-Table for topographical and map drawing is bringing it into use in this country; and to meet the demand for instruments of moderate cost and real efficiency we have introduced several patterns of the Plane-Table.

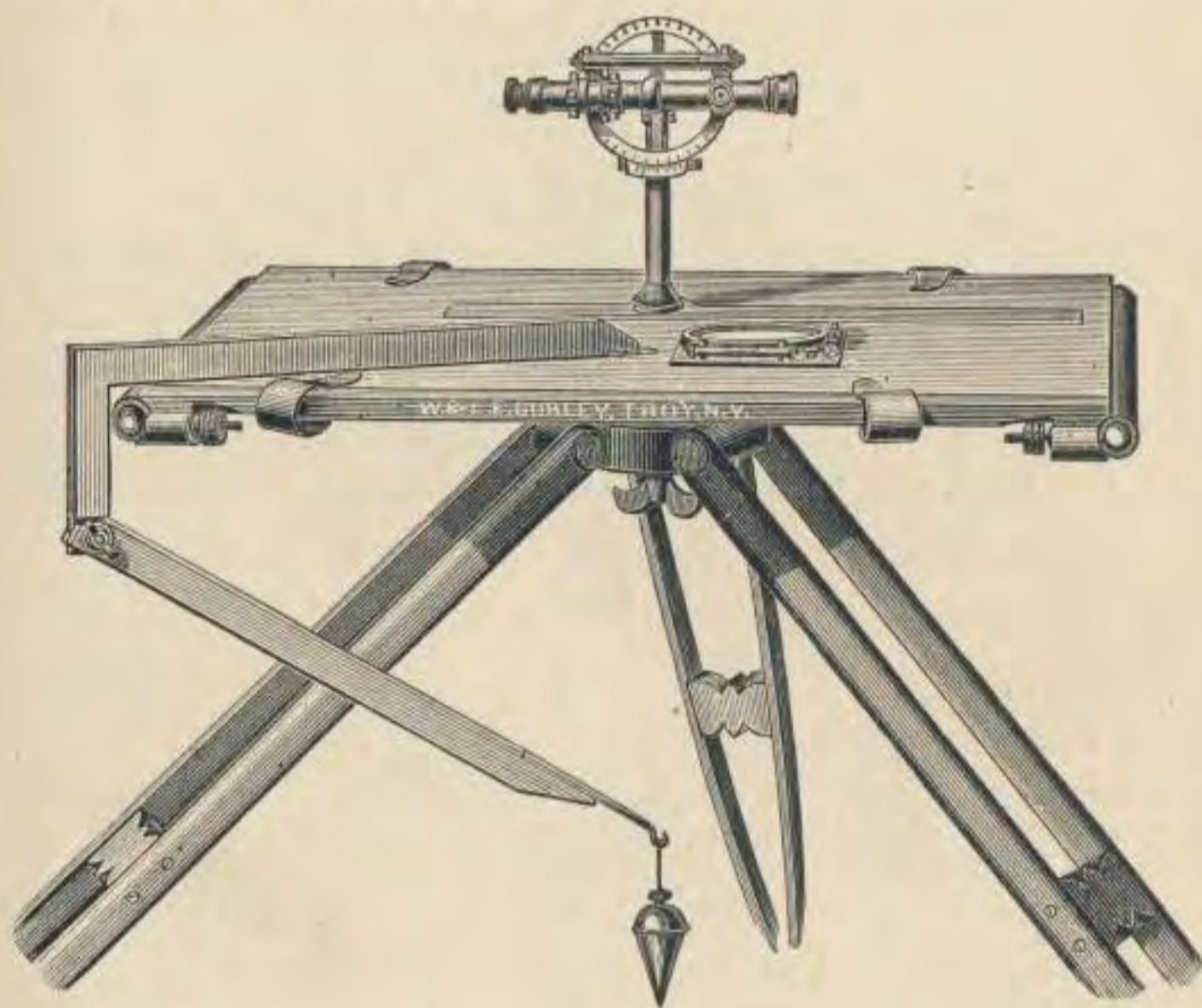

No.	NO. 553.	PRICE.
553.	Plane-Table, board 30x24 inches, mounted on large tripod, with leveling-socket and clamp, plumbing-arm, plummet and clamps for paper.....	\$45.00
	Combined Compass and levels.....	15.00
	Alidade, with telescope 9 inches long, power 20 diameters, with stadia, vertical circle to 1 minute, level on telescope and clamp and tangent, mounted on column as in engraving.....	70.00
	Price as shown, total.....	<u>\$130.00</u>

The Plane-Table consists mainly of a drawing-board upon a firm tripod, as shown in No. 553, having upon its upper surface a movable straight-edge or Alidade, arranged either with sight-vanes or telescope, by which it may be directed to any given point, a line being then drawn on the paper along the edge of the Alidade.

A square brass plate, to which is attached a Compass with two spirit-levels, is also shown, and serves both to level the table and, when applied by the edges parallel to the zero-lines of the compass-circle, to determine the magnetic bearing of the lines drawn on the paper, or the direction of the table itself.

The table is made of wood arranged in sections so as to prevent warping, and has an adjustable wooden roller at each end, by which the paper is brought down snugly to the board or upon which a long sheet can be rolled and unrolled at will. Sometimes in place of the rollers, and often in combination with them, a number of brass clamps, as shown, are used in holding the paper firmly.

Still another method of fastening the paper to the board is shown in the cut on page 195, in which are represented small brass screws passing through the paper and into brass sockets let into and slightly below the surface of the board. This method allows the Alidade to move over the surface without interference.

The plumbing-arm shown in the figure has its end brought to a point, that it may be set at any given point on the paper, the plummet hanging from the under arm determining the corresponding point on the ground. The lower arm moves upon a hinge, an index on the side showing when the ends of the two arms are plumb with each other as applied to the table.

The construction of the socket and tripod head is shown below, *a* representing the hemispherical concave **THE SOCKET** metal cup fastened by six screws to the **AND TRIPOD.** wooden top of the tripod, *b* the upper or convex part fitting nicely into the cup and clamped to it at will by the clamping piece, *c*, and nut, *d*. A strong spiral spring in the hollow cylinder between *c* and *d* serves to hold the two spherical surfaces of the socket together and allows the easy movement of one within the other in the leveling of the table.

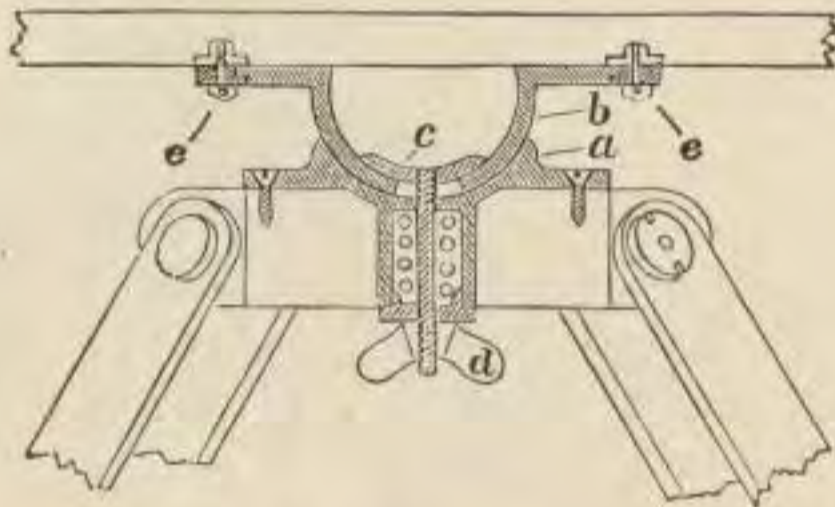

The flange of the socket, *b*, supports the table and is connected with its under surface by three segments of brass, two of which are shown at *e e*; a milled head screw passing through one of these segments serves to clamp the board to the flange at will, thus allowing the Plane-Table to be revolved horizontally.

*PLANE-TABLE WITH LEVELING-SCREWS
AND TANGENT MOVEMENT.*

The cut on page 192 shows a modification of the simple Plane-Table, there being added a tangent movement in azimuth and three screws for leveling.

The board appears as if cut away, to show in detail the socket and leveling-screws and tangent movement, by which, as will be seen, a more delicate adjustment in alti-

tude and azimuth is obtained than by the simple movement before described.

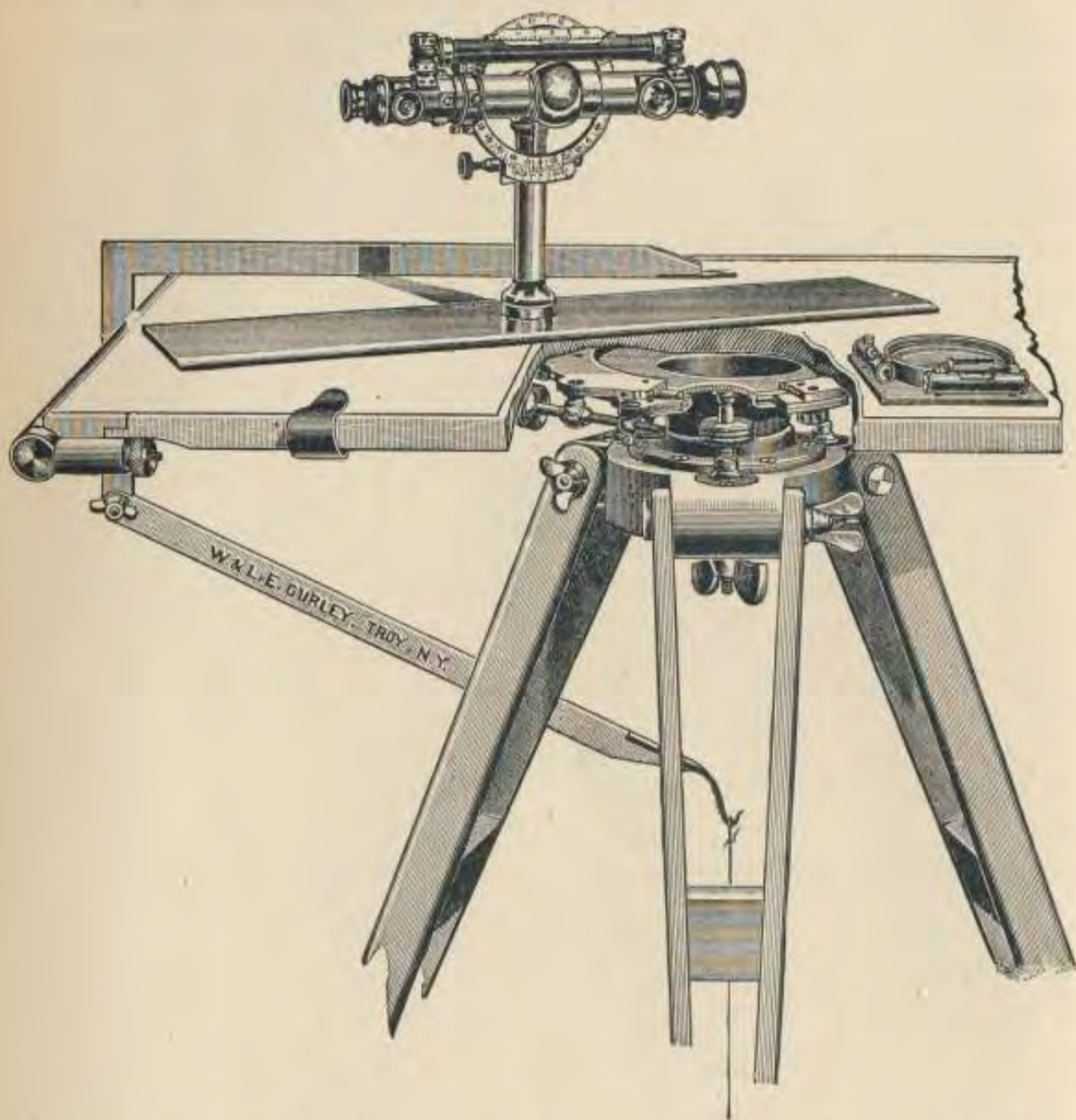

The Plane-Table outfit as shown above is our No. 549 and costs as follows :

	PRICE.
Plane-Table, board 30 x 24 inches, mounted on large tripod, with leveling-socket and clamp, and with plumbing-arm, plummet, and clamps for paper.....	\$45.00
Set of three leveling-screws.....	10.00
Clamp and tangent, for movement in azimuth.....	10.00
Combined Compass and levels, with square base	15.00
Alidade, with telescope 11 inches long, with stadia, $4\frac{1}{2}$ -inch vertical circle and vernier to 1 minute, level on telescope and clamp and tangent, on column, power of telescope 24 diameters.....	90.00
Total	\$170.00

The tripod is set up firmly, and the board with the upper half of the spherical socket attached is placed upon the lower half of the socket attached to the tripod, the wing clamping nut being screwed up until the table is secure upon the tripod. The board is then moved by the pressure of the hand, or by the leveling-screws, until the level-bubbles upon the compass-plate will remain in the middle upon any part of the surface. The wing-nut is now screwed up and the board made firm upon the tripod.

Any place on the drawing-board may then be assumed as a starting-point, its position over a given point on the ground being determined by the plumbing-arm and plummet. From the given point on the paper sights can be taken to different corners of the field, and lines drawn on the paper along the edge of the Alidade. Thus a miniature of the tract can be traced on the paper, the bearing of any line being ascertained by applying the side of the compass-plate to the edge of the Alidade placed on that line. The table can be moved in azimuth, either by the hand, on releasing the milled head screw that clamps the flange, or by the tangent screw as before described.

The measurement of distances by the stadia wires of the telescope, and of vertical angles by the circle, is effected as already described in our account of the Transit.

*JOHNSON'S IMPROVED PLANE-TABLE
MOVEMENT.*

(PATENTED.)

We illustrate on page 195 what is known as the Johnson Plane-Table Movement, complete with large Alidade, Plumbing-Arm and Compass.

The board is shown as cut away, to give a better view of the tripod and movement. In the lower corner is shown the movement alone, with a portion cut away to show the construction.

This movement has been largely used by the topographers of the U. S. Geological Survey.

As shown in the cut, this movement supplies an arrangement whereby the table can be easily made horizontal and then secured by the large wing-nut, A. If desired to turn the board in azimuth the wing-nut, B, is loosened, leaving the hemispherical surface, bearing the board secured to the flange, free to turn, and it can be clamped at will by screwing up the same nut. This movement as modified in recent years supplies an extremely efficient and portable Plane-Table.

The movement with legs complete weighs about nine pounds. The legs are made of straight-grained second-growth hickory, and the construction of the whole tripod is such as to secure strength and accuracy, and it is capable of standing rough usage without getting out of order.

NOTE.— Any of the Alidades, as described on pages 196 and 197, can be used with Johnson's Plane-Table.

See pages 267 and 268 for a list of Johnson's Plane-Table outfits, with prices.

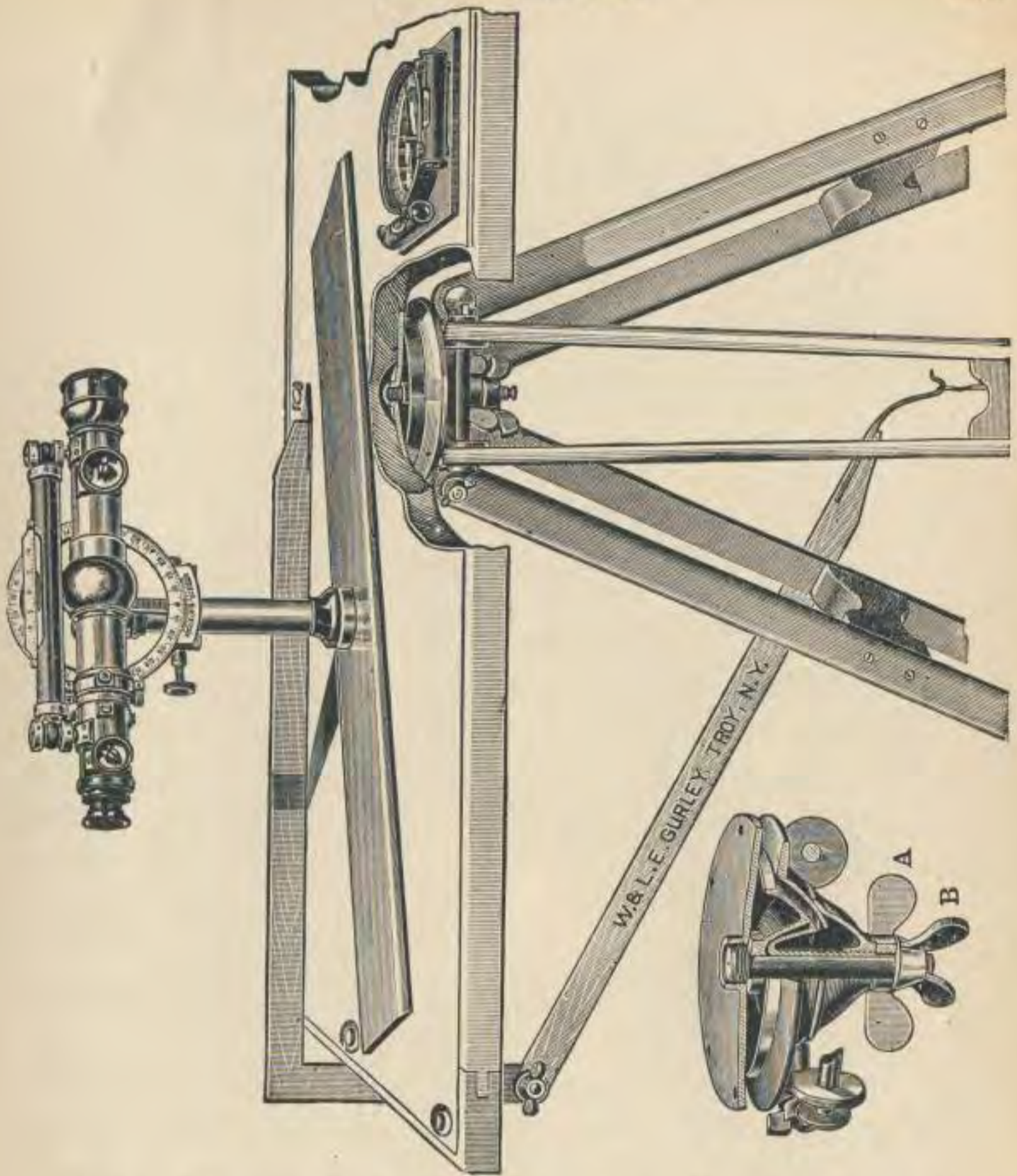

The Johnson Plane-Table outfit as shown above is our No. 576, and costs as follows :

	PRICE.
Johnson's Improved Plane-Table movement, mounted on large tripod.....	\$45.00
Plane-Table Drawing-Board 31 x 24 inches, fitted, and with screw-sockets and clamps for paper.....	5.00
Plumbing-arm and plummet.....	4.00
Combined Compass and levels with square base.....	15.00
Alidade, with telescope 11 inches long, with stadia, 4½-inch vertical circle and vernier to 1 minute, level on telescope and clamp and tangent, on column, power of telescope 24 diameters.....	90.00
Total.....	\$159.00

THE ALIDADES.

The different patterns of our Plane-Tables vary mainly in their Alidades, of which we make four kinds.

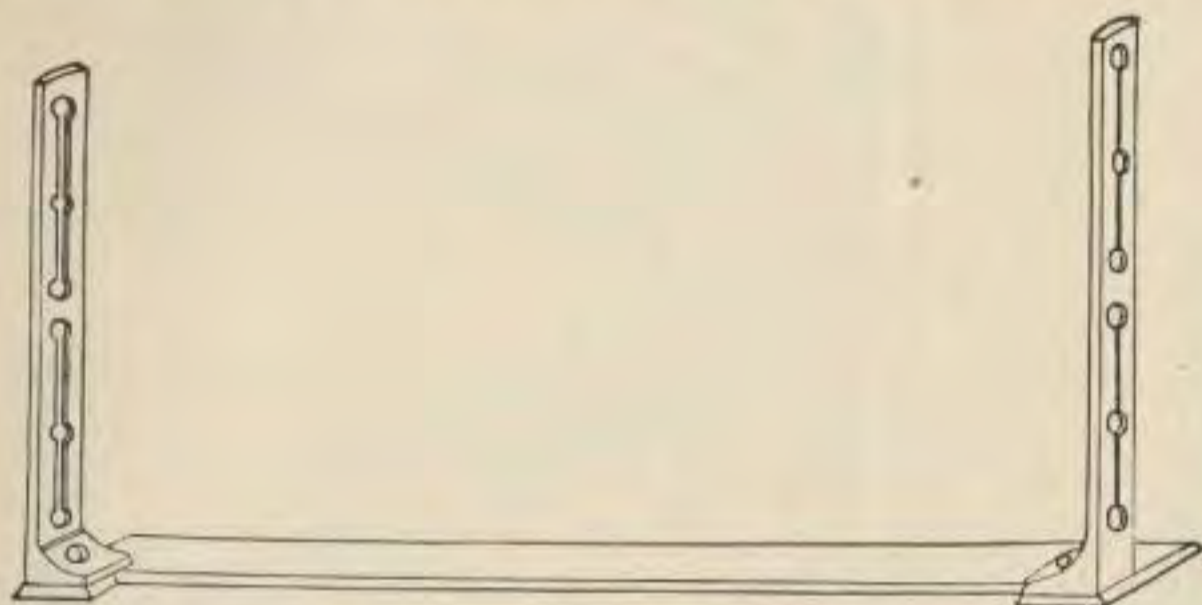

No. 580. Price, \$15.00.

The simplest Alidade is shown above, and consists of a brass ruler or straight-edge, twenty inches long and about three inches wide, at the ends of which sight-vanes are mounted like those on the ordinary compass. The edge of the ruler is chamfered and in line with the slots of the vanes.

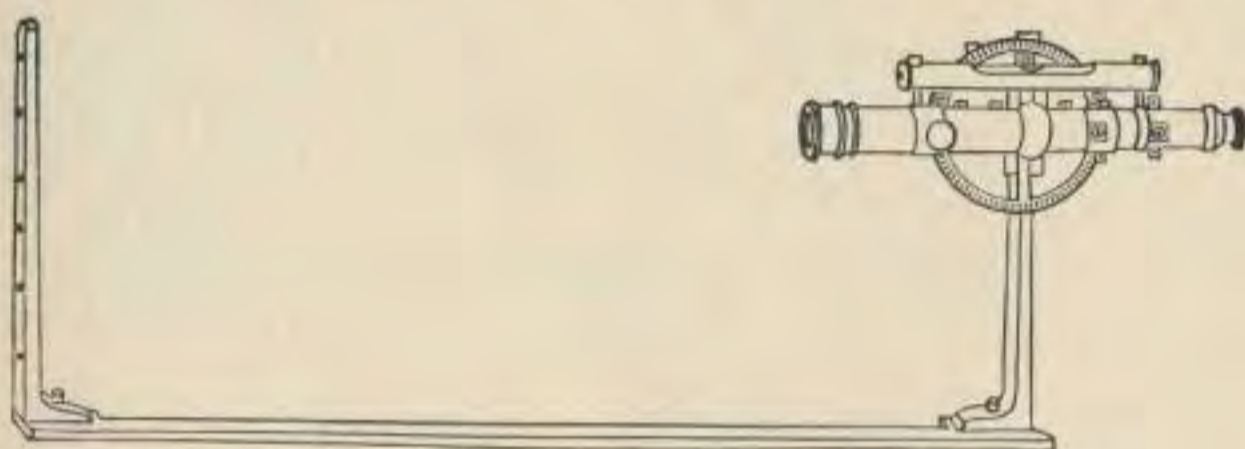

No. 581. Price, \$50.00.

The lower figure shows the simple Alidade to which is fitted the Telescopic Sight, having a level, clamp and tangent and vertical circle reading to five minutes, attached to the telescope, which has also stadia wires. The telescope is placed in line with the fiducial edge.

The third style of Alidade, No. 582, is shown in the cut of the Plane-Table on page 189, the brass ruler being three inches wide.

The column supports the telescope with its attachments, the vertical circle being graduated on silver and reading to single minutes.

The telescope is nine inches long, with a power of twenty diameters, provided with stadia wires and adjusted like that of the Transit.

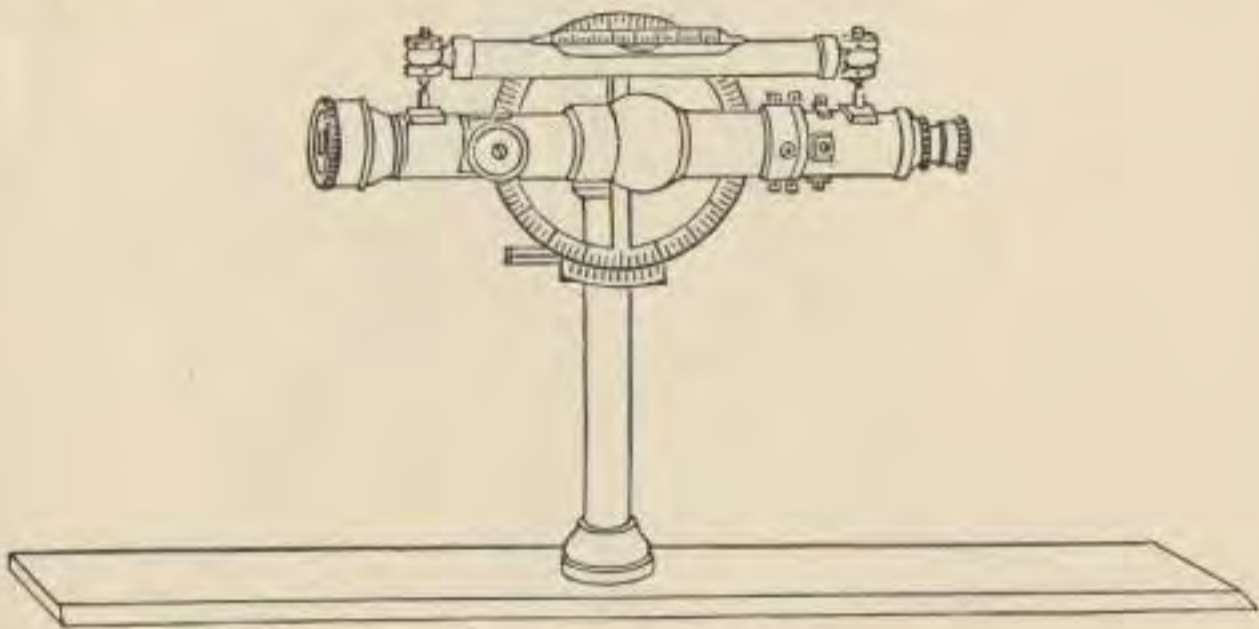

No. 583. Price, \$90.00.

In the Alidade shown in cut No. 583, the telescope is the same as that used in our best Transits, having also level, clamp and tangent, vertical circle on silver reading to single minutes, and stadia wires for measuring distances.

It is placed on a brass ruler four inches wide, and is adjusted and used in the same manner as the one just described.

THE TRAVERSE PLANE-TABLE.

The cut, No. 586, represents a simple form of Plane-Table and Alidade, which is used extensively by the U. S. Geological Survey for traverse work. The board is fifteen inches square, and has on the under side a small brass

flange, into which the clamp-screw of the tripod head enters and secures the board to the tripod. The Alidade consists of a brass ruler, beveled and graduated on one

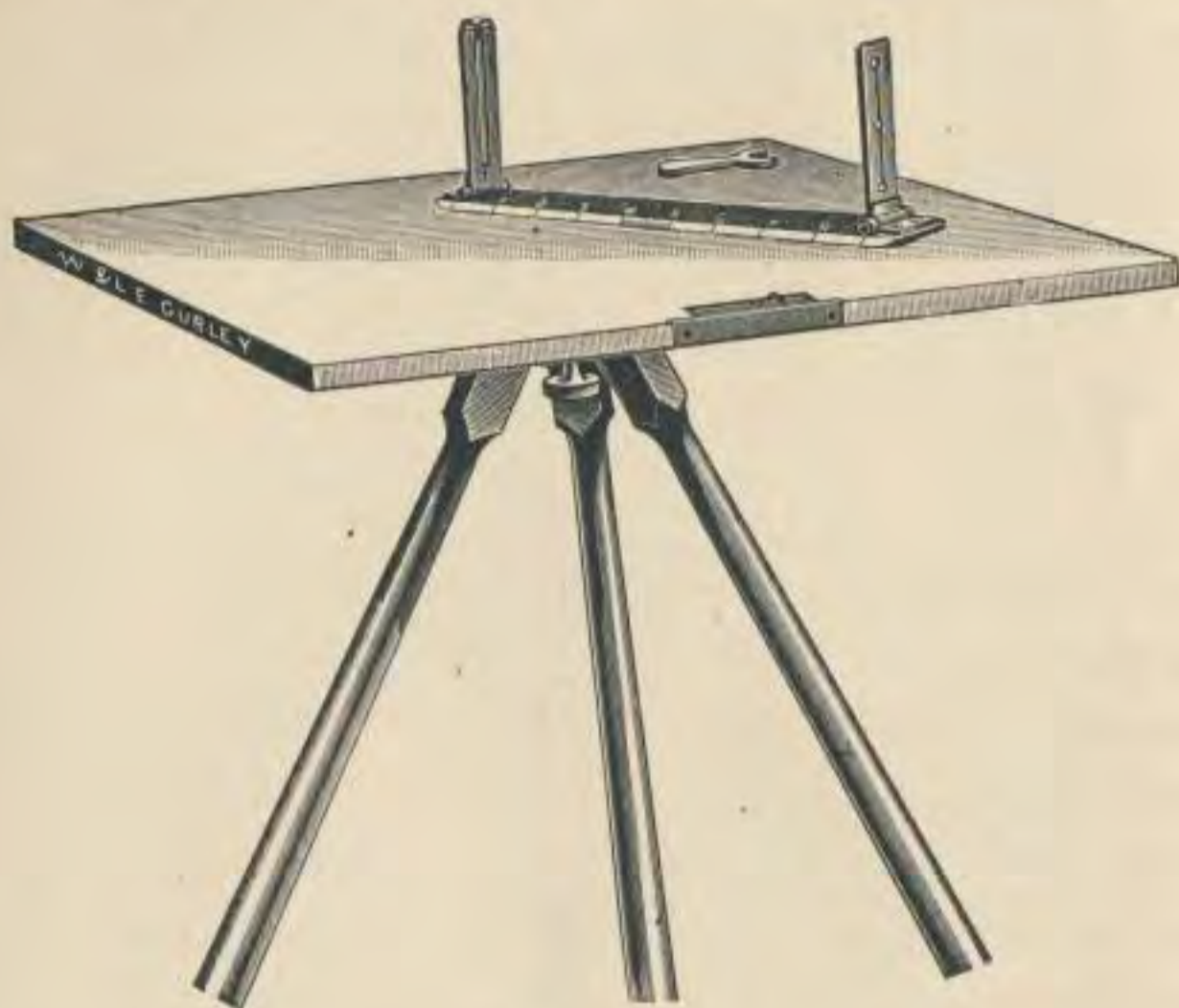

No. 586.

Price as shown, \$25.00; if the tripod has extension legs, add extra \$5.00.

edge, having at each end hinged sights which fold close to the surface of the ruler. Inserted in one edge of the board is a small Box-Compass with needle about three inches long.

The tripod legs are of cherry, and are attached to a simple head which has a clamping screw passing through its center, compressing a concealed spring and holding the board to the tripod head, at the same time allowing a motion in azimuth if desired.

The whole, while not capable of as accurate work as the larger Plane-Tables, supplies a light and portable instrument for topography.

THE CURRENT-METER.

AFTER six years' experience in measuring the velocity of water in the Ohio and Mississippi rivers by different methods, W. G. PRICE, U. S. Assistant Engineer, devised the Current-Meter known by his name, and shown herewith. It is used by the U. S. Engineer Corps, the U. S. Coast and Geodetic Survey, and by Hydraulic Engineers in different parts of the country.

**BUCKET-
WHEEL.** The wheel of this Meter carries five conical buckets as shown, so arranged as to feel the force of the slightest current and cause the wheel to revolve.

The ends of the axis of the wheel revolve in bearings contained in air chambers of metal, which protect them from the water and any gritty matter it may contain, and the friction is thus reduced to a minimum and made a constant quantity. The form of the wheel and buckets is such as to insure great strength and thus resist injury from driftwood, while at the same time it is not liable to obstruction from floating leaves and grass.

The axis of the wheel, at the upper end, extends above its bearing, entering an air-tight metal box hereafter named, and is cut down for a short distance, forming an **AXIS.** eccentric. One-half of the end of the shaft is cut away, and this piece is then replaced with a thin slip of ivory between the two parts, insulating them from each other.

A light spring, so arranged that it comes in contact with the eccentric, bears upon this divided part of the axis and successively makes and breaks the electric circuit as the wheel revolves.

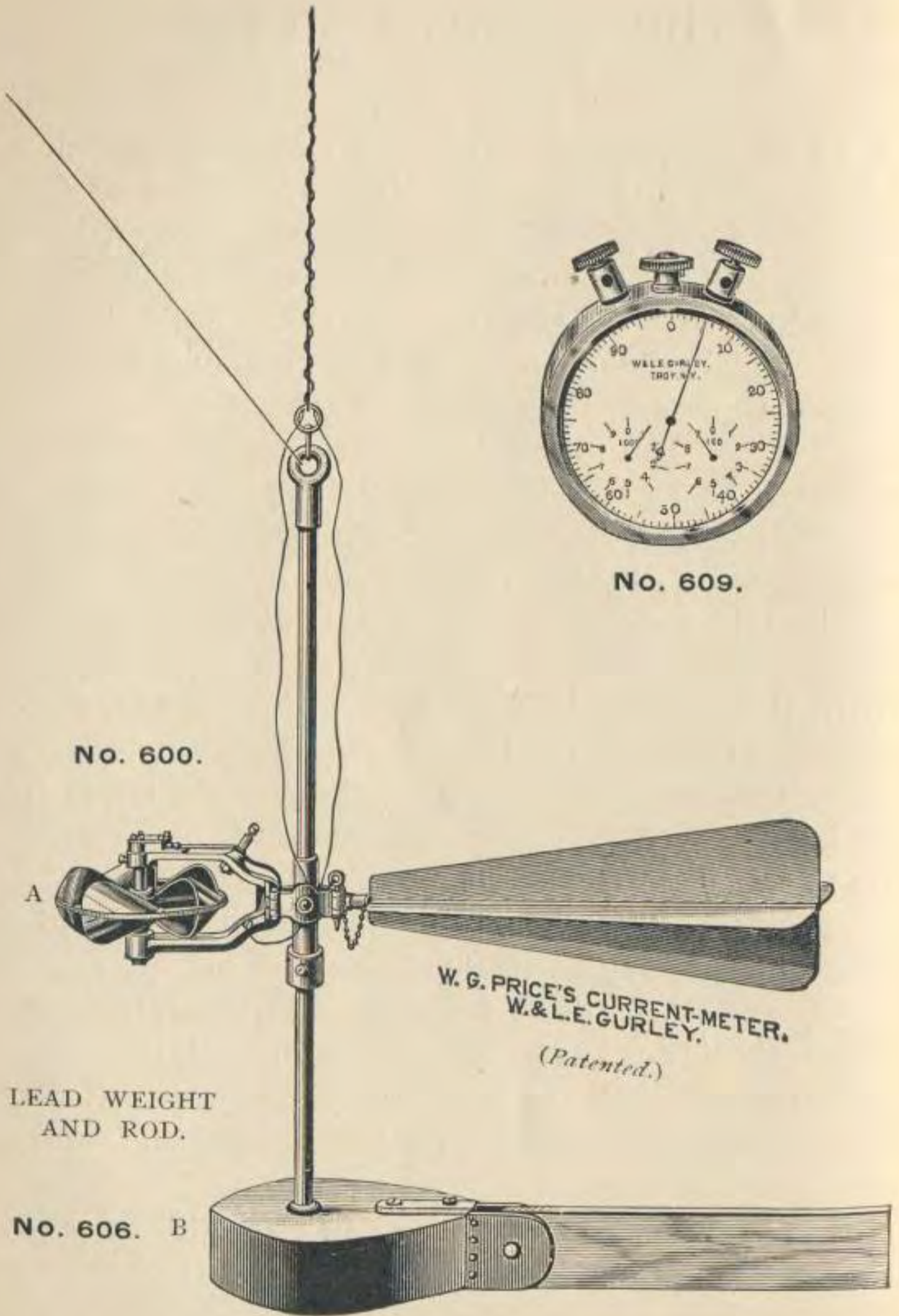

The spring and divided axis form the *contact-breaker*, and are both contained in the little metal air-tight box which is shown in the cut.

A hollow cylinder of bronze, called the trunnion, fitting easily upon the rod, supports the frame of the Meter

TRUNNION. by a pivot on each side, and thus by the rod and pivots the Meter is free to move both horizontally and vertically, and so adjust itself to the direction of the current.

The frame of the Meter is made of bronze, and is very solid and strong. The rudder has four light metal wings

FRAME AND RUDDER. or vanes, secured to a central rod, and is made to balance the weight of the wheel and give direction to it, and thus keep the wheel in both directions in line with the current.

The Meter-frame has a hinged side secured by a spring key, allowing the Meter and trunnion, which is itself in two parts, to be detached from the rod when desired. In the older form the trunnion was left on the rod.

The connecting wires are passed upward through the trunnion of the Meter, and so have no tendency to pull the Meter out of the line of the current.

The rod is of brass three-quarters of an inch in diameter and two feet long, its upper end having an eye of brass screwed firmly on and pinned, and its lower end screwed into a brass socket in the lead weight, B, and secured thereto by a jam-nut. A sliding ring of metal with set-screw, as shown, allows the Meter to be raised to any point on the rod.

The weight, No. 606, is of lead and weighs about sixty pounds; it has a rudder of wood, as shown,
LEAD WEIGHT. secured to the weight by brass cheek-pieces, which are also securely fastened to the weight by

sockets cast into the lead. The rudder can be set at an angle with the weight, or turned up parallel with the rod, for convenience in transportation.

The weight, B, is only used where the Meter is employed in deep water and harbor surveying, where the currents are very strong.

In shallower waters the Meter is suspended upon a brass rod. These rods are each four feet long and can be screwed together when a long length is needed. They are graduated to feet and tenths.

SIZE OF THE METER.

We now make but one size of this Meter, having a wheel six inches in diameter, and the total length, including the rudder-vane, is about twenty-four and one-half inches long. This Meter is adapted for deep water and harbor surveying, and also for use in smaller rivers and streams, and is used either with or without the weight.

RATING THE METER.

Before using the Meter it is necessary to obtain its rating, which is the number of revolutions of its wheel made in passing over a measured distance, at different velocities.

The Meter should be rated in still water which is not less than five feet deep, and to secure a good rating there should be but little wind.

It should be attached to the bow of a skiff, as shown in the cut, and immersed not less than two feet. The boat should have no rudder. The observer should also stake out two parallel range-lines on shore, about two hundred feet apart and at right angles with the course the boat is to take.

Attach a quarter-inch cotton cord about three hundred feet long to the bow of the boat, and pass it around a

pulley which is placed in line with the course ; if there is a bend in the shore the pulley may not be necessary.

It will require three or four men to pull the boat fast enough for the high velocities, and there must be a boatman with oars in the boat with the observer, to prevent its running into the shore.

Haul the boat over the measured base at very slow, very fast and medium velocities, which should be as nearly uniform as possible during each passage.

Note before each trial if the Meter is free to point in the direction of the current, as the connecting wires are



liable, in backing over the course, to get twisted so as to pull the Meter out of line.

Fasten a vertical rod on the boat near the seat of the observer, to enable him to sight at the range stakes as he passes them ; start the Time-Recorder (No. 619 of Price-List) and Electric Register on the first range-line and stop them on the second ; and note accurately the time as given by the stop-watch, and the number of revolutions of the wheel as indicated by the Register.

The rating of a Meter (which is, in brief, the value in feet per second of one revolution of the wheel,) will not change as long as the wheel turns freely and has not been seriously injured.

The velocity of a current of water can readily be computed from the Reduction-Table furnished with the instrument,

and also given on pages 205 and 206, the number of revolutions of the wheel per second having been already ascertained by observation, and recorded by the Register.

ELECTRIC REGISTER.

The Electric Register, No. 609, is enclosed in a brass case, showing three dials under a glass face, and has an electro-magnet which, when the circuit is made, moves a lever, at the end of which is a pawl carrying forward a ratchet-wheel one tooth at every break of the current.

The large dial is graduated into one hundred spaces and two small dials into ten spaces each, all reading from left to right. The large dial counts each revolution up to one hundred,—the small dial on the right counts one thousand revolutions by each hundred,—and the small dial on the left counts ten thousand revolutions by each thousand,—all indicated by the figuring.

The electric current proceeding from one pole of the battery is carried by an insulated copper wire down through the trunnion of the Meter, and thence up to the insulated binding-post on the upper arm, as shown in the cut; thence through the contact-breaker, the axis of the wheel, and the lower arm, to the binding-screw shown on that arm; thence by a second copper wire up through the trunnion to one binding-screw of the Register; thence through the Register to the other binding-post; and thence finally by another wire to the other pole of the battery.

We furnish either a dry-cell or wet-cell battery, as may be preferred, to operate the Electric Register.

BATTERY. Each battery is composed of three cells enclosed in a neat wooden case, with lock and strap.

See Nos. 610 and 612 of the Price-List.

REDUCTION-TABLE FOR USE WITH
PRICE'S PATENT CURRENT-METER, No. 600
WITH 6-INCH WHEEL.

This Table is a mean of several ratings, and will probably give correct velocities within one per cent. for any Meter when in good order.

Measurements and computations by W. G. PRICE, United States Assistant Engineer.

REV. PER SEC.	VEL. PER SEC.	REV. PER SEC.	VEL. PER SEC.	REV. PER SEC.	VEL. PER SEC.	REV. PER SEC.	VEL. PER SEC.
0.00	0.145	0.39	1.372	0.78	2.584	1.17	3.766
0.01	0.176	0.40	1.404	0.79	2.614	1.18	3.796
0.02	0.208	0.41	1.435	0.80	2.645	1.19	3.826
0.03	0.239	0.42	1.467	0.81	2.676	1.20	3.856
0.04	0.271	0.43	1.498	0.82	2.706	1.21	3.886
0.05	0.302	0.44	1.529	0.83	2.737	1.22	3.916
0.06	0.334	0.45	1.560	0.84	2.767	1.23	3.945
0.07	0.365	0.46	1.592	0.85	2.798	1.24	3.975
0.08	0.397	0.47	1.623	0.86	2.829	1.25	4.005
0.09	0.428	0.48	1.654	0.87	2.859	1.26	4.035
0.10	0.460	0.49	1.686	0.88	2.890	1.27	4.065
0.11	0.491	0.50	1.717	0.89	2.920	1.28	4.094
0.12	0.523	0.51	1.748	0.90	2.951	1.29	4.124
0.13	0.554	0.52	1.779	0.91	2.981	1.30	4.154
0.14	0.586	0.53	1.811	0.92	3.012	1.31	4.183
0.15	0.617	0.54	1.842	0.93	3.042	1.32	4.213
0.16	0.649	0.55	1.873	0.94	3.073	1.33	4.242
0.17	0.680	0.56	1.904	0.95	3.103	1.34	4.272
0.18	0.712	0.57	1.935	0.96	3.133	1.35	4.301
0.19	0.743	0.58	1.967	0.97	3.164	1.36	4.331
0.20	0.775	0.59	1.998	0.98	3.194	1.37	4.360
0.21	0.806	0.60	2.029	0.99	3.225	1.38	4.390
0.22	0.838	0.61	2.060	1.00	3.255	1.39	4.419
0.23	0.869	0.62	2.091	1.01	3.285	1.40	4.449
0.24	0.901	0.63	2.122	1.02	3.315	1.41	4.478
0.25	0.932	0.64	2.153	1.03	3.345	1.42	4.508
0.26	0.963	0.65	2.183	1.04	3.375	1.43	4.537
0.27	0.995	0.66	2.214	1.05	3.405	1.44	4.566
0.28	1.026	0.67	2.245	1.06	3.436	1.45	4.595
0.29	1.058	0.68	2.276	1.07	3.466	1.46	4.624
0.30	1.089	0.69	2.307	1.08	3.496	1.47	4.654
0.31	1.120	0.70	2.338	1.09	3.526	1.48	4.683
0.32	1.152	0.71	2.369	1.10	3.556	1.49	4.713
0.33	1.183	0.72	2.399	1.11	3.586	1.50	4.742
0.34	1.215	0.73	2.430	1.12	3.616	1.51	4.771
0.35	1.246	0.74	2.461	1.13	3.646	1.52	4.800
0.36	1.278	0.75	2.491	1.14	3.676	1.53	4.829
0.37	1.309	0.76	2.522	1.15	3.706	1.54	4.858
0.38	1.341	0.77	2.553	1.16	3.736	1.55	4.887

VELOCITIES ARE IN FEET PER SECOND.

REDUCTION-TABLE.— *Continued.*

REV. PER SEC.	VEL. PER SEC.	REV. PER SEC.	VEL. PER SEC.	REV. PER SEC.	VEL. PER SEC.	REV. PER SEC.	VEL. PER SEC.
1.56	4.917	1.85	5.755	2.14	6.584	2.43	7.400
1.57	4.946	1.86	5.784	2.15	6.612	2.44	7.428
1.58	4.975	1.87	5.813	2.16	6.640	2.45	7.456
1.59	5.004	1.88	5.842	2.17	6.669	2.46	7.484
1.60	5.033	1.89	5.870	2.18	6.697	2.47	7.512
1.61	5.062	1.90	5.899	2.19	6.726	2.48	7.540
1.62	5.091	1.91	5.928	2.20	6.754	2.49	7.568
1.63	5.120	1.92	5.956	2.21	6.782	2.50	7.596
1.64	5.149	1.93	5.985	2.22	6.810	2.51	7.624
1.65	5.178	1.94	6.013	2.23	6.838	2.52	7.652
1.66	5.207	1.95	6.042	2.24	6.866	2.53	7.680
1.67	5.236	1.96	6.071	2.25	6.894	2.54	7.708
1.68	5.265	1.97	6.099	2.26	6.923	2.55	7.735
1.69	5.294	1.98	6.128	2.27	6.951	2.56	7.763
1.70	5.323	1.99	6.156	2.28	6.979	2.57	7.791
1.71	5.352	2.00	6.185	2.29	7.007	2.58	7.819
1.72	5.381	2.01	6.213	2.30	7.035	2.59	7.847
1.73	5.410	2.02	6.242	2.31	7.063	2.60	7.875
1.74	5.439	2.03	6.270	2.32	7.091	2.61	7.903
1.75	5.467	2.04	6.299	2.33	7.119	2.62	7.931
1.76	5.496	2.05	6.327	2.34	7.147	2.63	7.958
1.77	5.525	2.06	6.356	2.35	7.175	2.64	7.986
1.78	5.554	2.07	6.384	2.36	7.204	2.65	8.014
1.79	5.583	2.08	6.413	2.37	7.232	2.66	8.042
1.80	5.612	2.09	6.441	2.38	7.260	2.67	8.070
1.81	5.641	2.10	6.470	2.39	7.288	2.68	8.097
1.82	5.669	2.11	6.498	2.40	7.316	2.69	8.125
1.83	5.698	2.12	6.527	2.41	7.344	2.70	8.153
1.84	5.727	2.13	6.555	2.42	7.372		

VELOCITIES ARE IN FEET PER SECOND.

REDUCTION - TABLE.

To be used in reducing observed velocities to the mean vertical velocity. The mean velocity is about ninety-six per cent. of the mid-depth velocity.

DEPTH.	PER CENT.	DEPTH.	PER CENT.	DEPTH.	PER CENT.
$\frac{1}{10}$	0.952	$\frac{4}{10}$	0.953	$\frac{7}{10}$	0.984
$\frac{2}{10}$	0.951	$\frac{5}{10}$	0.960	$\frac{8}{10}$	1.020
$\frac{3}{10}$	0.948	$\frac{6}{10}$	0.965	$\frac{9}{10}$	1.140

MULTIPLY THE MEASURED VELOCITY BY THE PERCENTAGE.

PRICE'S ACOUSTIC CURRENT-METER.

(PATENTED.)

This Meter was devised by W. G. PRICE, and has many points of excellence. It is very compact, light and portable, and is especially designed for use in irrigation ditches, or streams where there is little depth of water. The cut shows



No. 616.
Price, \$50.00.

the external appearance of the Meter, with the brass tubes by which it is held while in use. The revolutions of the wheel are indicated by a hammer striking against a diaphragm, one blow for every ten revolutions, and the recording mechanism is enclosed in the stem of the Meter and thoroughly protected from injury. The sound of the recording stroke is transmitted through the tubing supporting the Meter, and is conveyed to the ear of the operator by the rubber ear-tube. In use the operator fixes the ear-tube in position by a rubber

band passing around his head, and thus both hands are left free for the manipulation of the Meter. Results obtained may be readily reduced by the use of the Reduction-Table supplied with the Meter, and also given on pages 208 and 209.

Each Meter is packed in a wooden box with lock and strap, and is provided with two lengths of nickel-plated brass tubing, graduated to feet and tenths up to four feet, and with four feet of rubber tubing with all necessary connections. Extra graduated brass tubing, in lengths of two feet, will be furnished when desired, at a cost of \$2.50 per length.

REDUCTION-TABLE FOR USE WITH
PRICE'S PATENT ACOUSTIC CURRENT-METER.

The time column is the number of seconds occupied by one hundred revolutions of the wheel, there being ten revolutions to each "rap."

The velocity column is the velocity in feet per second.

TIME.	VELOCITY.	TIME.	VELOCITY.	TIME.	VELOCITY.	TIME.	VELOCITY.
700	0.377	298	0.843	256	0.981	214	1.166
690	0.383	297	0.846	255	0.985	213	1.170
680	0.389	296	0.849	254	0.988	212	1.176
670	0.394	295	0.853	253	0.991	211	1.183
660	0.400	294	0.856	252	0.995	210	1.189
650	0.406	293	0.860	251	1.000	209	1.195
640	0.413	292	0.863	250	1.004	208	1.199
630	0.419	291	0.866	249	1.008	207	1.204
620	0.426	290	0.868	248	1.012	206	1.208
610	0.432	289	0.871	247	1.016	205	1.214
600	0.439	288	0.874	246	1.019	204	1.220
590	0.447	287	0.877	245	1.023	203	1.226
580	0.454	286	0.879	244	1.027	202	1.233
570	0.462	285	0.882	243	1.032	201	1.239
560	0.469	284	0.886	242	1.036	200	1.247
550	0.477	283	0.889	241	1.040	199	1.253
540	0.485	282	0.893	240	1.044	198	1.258
530	0.493	281	0.896	239	1.048	197	1.263
520	0.502	280	0.899	238	1.052	196	1.270
510	0.511	279	0.902	237	1.056	195	1.277
500	0.520	278	0.905	236	1.060	194	1.284
490	0.529	277	0.908	235	1.064	193	1.291
480	0.538	276	0.911	234	1.067	192	1.297
470	0.546	275	0.914	233	1.071	191	1.303
460	0.555	274	0.917	232	1.076	190	1.310
450	0.569	273	0.920	231	1.082	189	1.316
440	0.583	272	0.924	230	1.087	188	1.322
430	0.597	271	0.928	229	1.092	187	1.328
420	0.610	270	0.932	228	1.097	186	1.335
410	0.624	269	0.936	227	1.102	185	1.342
400	0.637	268	0.939	226	1.106	184	1.349
390	0.653	267	0.942	225	1.111	183	1.357
380	0.668	266	0.944	224	1.116	182	1.363
370	0.684	265	0.947	223	1.121	181	1.370
360	0.705	264	0.951	222	1.126	180	1.377
350	0.726	263	0.955	221	1.131	179	1.385
340	0.747	262	0.959	220	1.136	178	1.393
330	0.768	261	0.963	219	1.142	177	1.401
320	0.789	260	0.967	218	1.147	176	1.408
310	0.813	259	0.971	217	1.152	175	1.416
300	0.837	258	0.974	216	1.157	174	1.424
299	0.840	257	0.978	215	1.161	173	1.432

REDUCTION-TABLE.—*Continued.*

The time column is the number of seconds occupied by one hundred revolutions of the wheel, there being ten revolutions to each "rap."

The velocity column is the velocity in feet per second.

TIME.	VELOCITY.	TIME.	VELOCITY.	TIME.	VELOCITY.	TIME.	VELOCITY.
172	1.439	133	1.847	91	2.600	55	4.399
171	1.446	132	1.859	93	2.629	54	4.477
170	1.453	131	1.873	92	2.657	53	4.560
169	1.461	130	1.887	91	2.686	52	4.647
168	1.469	129	1.901	90	2.714	51	4.737
167	1.477	128	1.917	89	2.742	50	4.830
166	1.485	127	1.932	88	2.770	49	4.926
165	1.494	126	1.947	87	2.800	48	5.026
164	1.502	125	1.962	86	2.834	47	5.132
163	1.510	124	1.977	85	2.867	46	5.242
162	1.521	123	1.992	84	2.902	45	5.354
161	1.532	122	2.008	83	2.938	44	5.473
160	1.544	121	2.023	82	2.973	43	5.598
159	1.553	120	2.040	81	3.008	42	5.730
158	1.560	119	2.058	80	3.044	41	5.866
157	1.570	118	2.077	79	3.083	40	6.011
156	1.580	117	2.096	78	3.123	39	6.161
155	1.592	116	2.115	77	3.164	38	6.323
154	1.602	115	2.133	76	3.205	37	6.492
153	1.614	114	2.150	75	3.246	36	6.667
152	1.623	113	2.168	74	3.289	35	6.854
151	1.631	112	2.186	73	3.334	34	7.051
150	1.641	111	2.204	72	3.379	33	7.265
149	1.652	110	2.223	71	3.425	32	7.490
148	1.664	109	2.243	70	3.473	31	7.730
147	1.675	108	2.264	69	3.520	30	7.981
146	1.686	107	2.285	68	3.568	29	8.259
145	1.698	106	2.306	67	3.618	28	8.550
144	1.710	105	2.328	66	3.674	27	8.860
143	1.721	104	2.349	65	3.731	26	9.194
142	1.732	103	2.372	64	3.789	25	9.560
141	1.743	102	2.395	63	3.848	24	9.954
140	1.755	101	2.418	62	3.909	23	10.372
139	1.767	100	2.442	61	3.972	22	10.835
138	1.779	99	2.466	60	4.035	21	11.347
137	1.792	98	2.492	59	4.103	20	11.907
136	1.806	97	2.518	58	4.173		
135	1.819	96	2.545	57	4.245		
134	1.834	95	2.572	56	4.322		

BOYDEN'S HOOK-GAUGE,

So called from the name of its inventor, is used in determining the depth of water flowing over weirs, etc.

As represented in the cut, it has a frame of wood, three feet long and four inches wide, in a rectangular groove of which another piece is made to slide, carrying a metallic scale divided to feet and hundredths, and figured from zero to two feet and two-tenths, as shown.

Connected with the scale is a brass screw passing through a socket, fastened to another shorter sliding piece, shown above, which can be clamped at any point on the frame, and the scale with hook moved in either direction by the milled head nut.

There is also a vernier attached to the frame, and movable under the screw heads which secure it, in order to adjust its zero to correspond with the point of the hook, as will be described hereafter. The vernier reads the scale to thousandths of a foot.

The hook is of brass, and has a sharp point which, when raised to the surface of the water at rest, indicates its precise level.

TO USE THE HOOK-GAUGE.

The hook-gauge is used in a box attached to a flume at any convenient point near the weir, the water in the flume being conveyed to the box by rubber or lead pipes, and thus indicating the precise level of the water in the flume, the surface of the water in the box being also at rest.



No. 620.
Price, \$25.00.

When the depth of the water passing over a weir is required, the exact level of the crest of the weir should be taken by a leveling-instrument and rod, and designated by a line drawn in the still-water box above the surface of the water.

The scale of the gauge being previously set at zero with the vernier, the frame is fastened to the box above the water in such a position that the point of the hook is at the same level with that of the crest of the weir, the precise point being secured by the adjusting-screw of the scale.

Now see that the zeros of the scale and vernier are in line, and if not, move the vernier under the screw heads until the zeros correspond, and set the vernier fast.

The point of the hook will of course be under water, and at the same time level with that of the crest of the weir.

The depth of the water flowing over the weir is the distance between the point of the hook in the position named and the exact surface of the water.

To find this, the hook is raised by turning the milled head nut until the point of the hook, appearing a little above the surface, causes a distortion in the reflection of the light from the surface of the water; then a little movement of the hook in the opposite direction, so as just to cause the distortion to disappear, will indicate the surface with precision.

The reading of the scale will then give the depth of water passing over the weir, in thousandths of a foot.

It will be understood from the cut that the longer movements of the scale are made by moving the clamping piece over the frame, the smaller adjustments being effected by the milled nut.

TELESCOPIC HAND-LEVELS.

(PATENTED.)

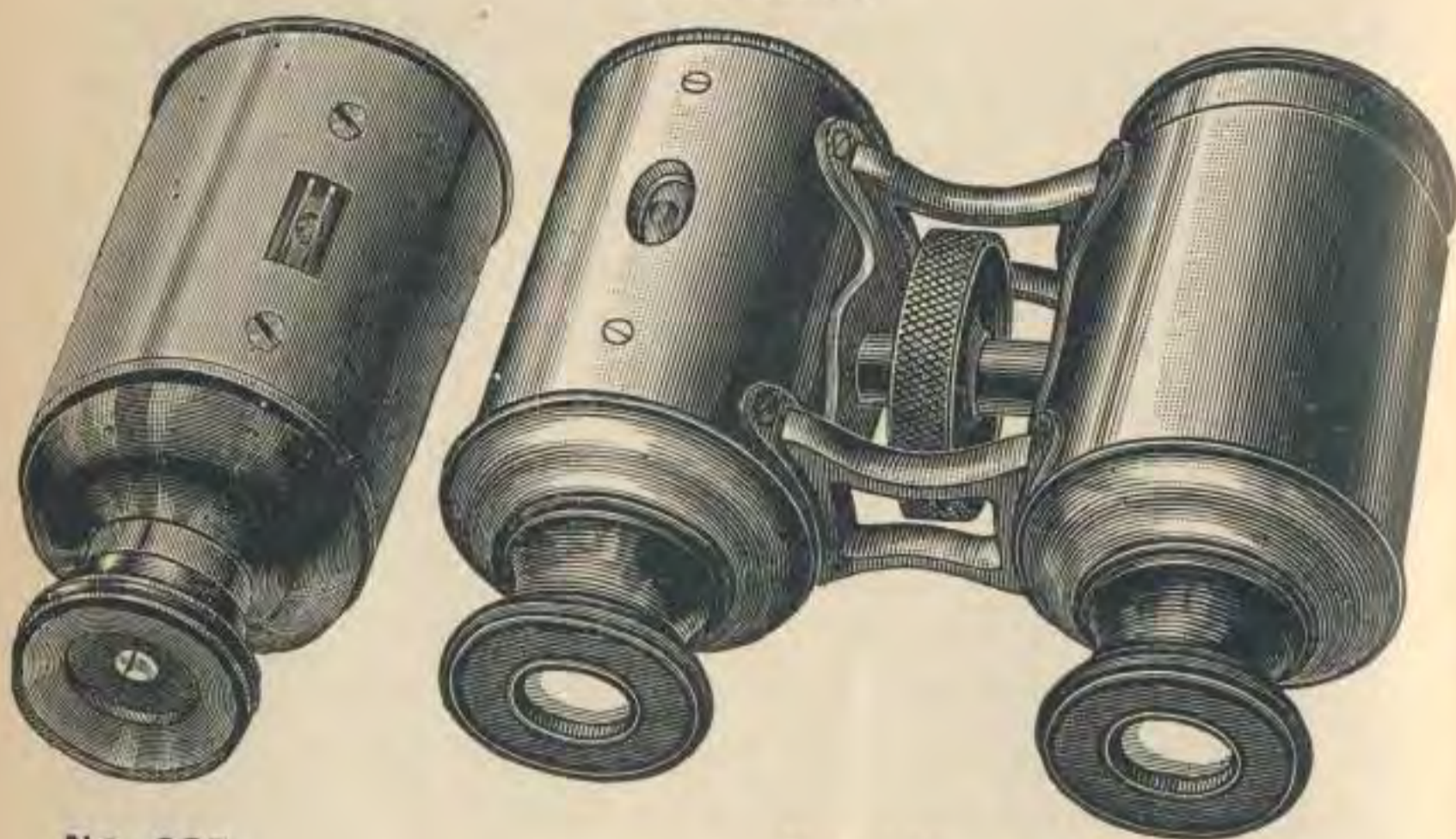
**No. 625.**

Price, \$12.00.

No. 627.

Price, \$15.00.

The figures represent instruments devised by us to remedy the defects of the ordinary Hand-Levels, and to increase their usefulness in the work of the Engineer.

The Monocular Hand-Level, shown as No. 625, consists of a tube to which are fitted the lenses of a single opera-glass, containing in addition a reflecting prism, cross-wire and small spirit-level, the last being shown in the open part of the tube.

The eye-lens, as indicated in the cut, is made of two separate pieces, the larger one being the usual concave eye-lens of the opera-glass and the smaller one a segment of a plano-convex lens, having its focus in a cross-wire under the level-vial and above the reflecting prism.

The observer holds the tube horizontal with the level-opening uppermost, and observes the object to which the

instrument is directed and the position of the level-bubble with reference to the cross-wire on the under side of the level-vial.

When the Hand-Level is held truly horizontal the cross-wire will bisect the bubble, and will also determine the level of any object seen through the telescope; thus securing to the observer a clear view of the object, magnified also by the telescope.

The Binocular Hand-Level, shown as No. 627, consists of two tubes, that on the right enclosing the usual lenses of the opera-glass, while the tube on the left contains only the prism, level-vial and cross-wire of the instrument just described.

This level is used like the ordinary opera-glass, the level being above, as shown in the cut.

When the tubes are held truly horizontal, the Engineer, with one eye, will see the level with the cross-wire below it bisecting the bubble, as before described and, with the other eye, the object observed, the level of which is determined by the position of the cross-wire upon its surface.

The use of the Binocular Hand-Level gives a clearer view of an object than is possible with a single tube, there being now no light lost by the interference of the prism and level-vial.

The Hand-Level is adjusted by sliding the prism-tube back and forth until the line given is the same as that given by a Y-Level.

The prism in the tube can be reached by removing the cap from the closed end of the tube, and it is clamped by a small screw on the lower side.

LOCKE'S HAND-LEVEL.**NO. 630.**

Price, \$8.00.

This instrument consists of a brass tube about six inches long, having, as shown in the figure, a small level on top and near the object-glass end. There is also an opening in the tube beneath, through which the bubble can be seen, as reflected by a prism immediately under the level. Both ends of the tube are closed by disks of plain glass to exclude the dust, and there is at the inner end of the sliding or eye-tube a semi-circular convex lens, which serves to magnify the level-bubble and the cross-wire beneath, while it allows the object to be clearly seen through the open half of the tube.

The cross-wire is fastened to a little frame moving under the level-tube and adjusted to its place by the small screw shown on the end of the level-case. The level of any object in line with the eye of the observer is determined by sighting upon it through the tube, and bringing the bubble of the level into a position where it is bisected by the cross-wire.

THE ABNEY LEVEL AND CLINOMETER.

The Abney Level is an English modification of the instrument shown above, combining with it an excellent

clinometer, as shown in the cut, No. 634. As now made the arc is graduated to ninety degrees each side of the zero.



No. 634

When the level-bubble is brought to the middle, by setting the vernier arm to zero on the graduated arc, the bubble is seen by looking through the eyepiece, and the level ascertained as with the Locke's Level. The main tube being square it can be applied to any surface, the inclination of which is ascertained by bringing the level-bubble into the middle, and reading off the angle to five minutes by the vernier and arc.

The inner and shorter arc indicates the lines of different degrees of slope, the left-hand end of the vernier being applied to the lines and the bubble being brought into the middle as usual. A small compass with needle about one and one-half inches long is sometimes attached to the upper surface of the Abney Level, with a staff socket below.

PRICES.

No.		PRICE.	POST.
634.	Abney Level, an improved "Locke's Hand-Level," giving angles of elevation, and is also divided for slopes, as 1 to 1, 2 to 1, etc.; in case.....	\$13.50	\$0.25
636.	Same as No. 634, and with compass and staff socket attached.....	18.00	.30

ODOMETER.

This is an instrument designed to register the number of revolutions of a wagon wheel, and thus indicate distances where extreme accuracy is not required.

In measuring distances with the Odometers Nos. 640 and 642, the carriage should not be driven faster than about six miles an hour.

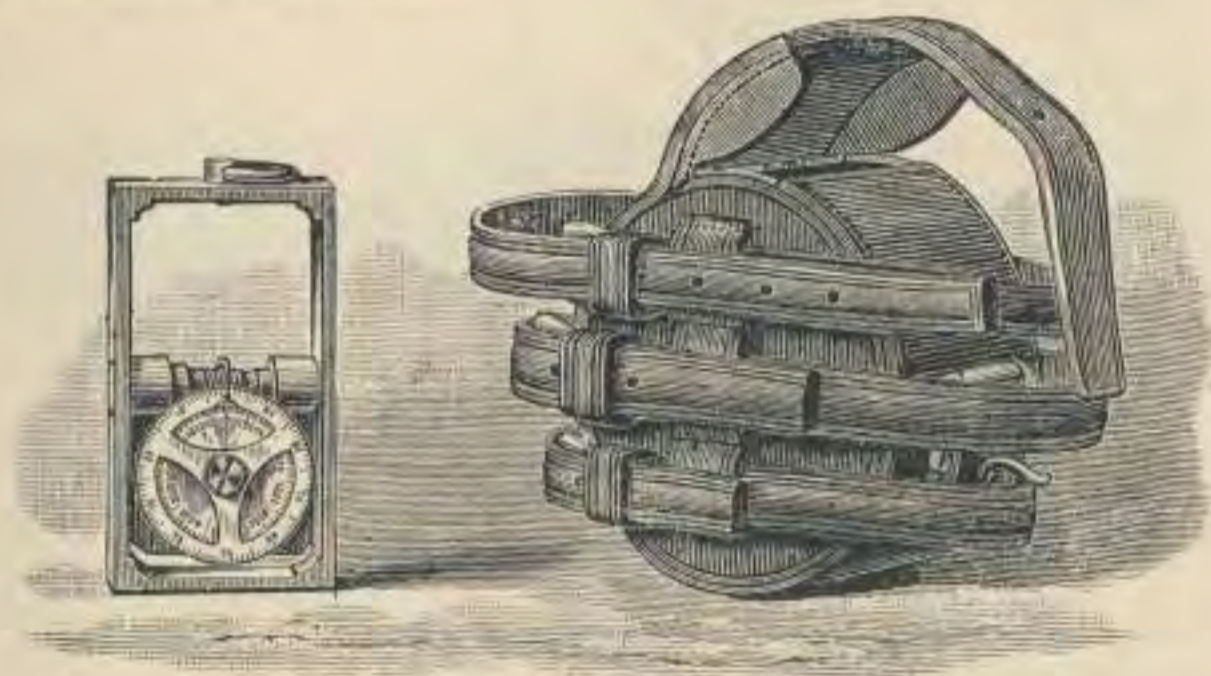

No. 640.

Price, \$15.00.

The Odometer here shown on the left consists essentially of a square brass weight or pendulum, hung within a rectangular frame which revolves with the wheel, while the pendulum remains vertical. Upon the front face of the pendulum are two brass wheels two inches in diameter, the inner surfaces of which are in contact, the edges of both uniting to make a groove corresponding to a worm cut in the middle of a shaft fastened to the sides of the frame.

The front wheel has one hundred teeth, the rear one ninety-nine, and both pitch into and are moved by the revolving worm of the frame. There are also the same number of graduations as of teeth on each wheel, and they are figured, the front wheel from 0 to 100, the rear one from 0 to 9,000.

The front wheel has three spokes, an index being cut down on its perimeter to read the graduations of the rear wheel, the front wheel itself being read by a slender steel wire fastened to the brass weight and curving over the worm, so as to be immediately over the graduations of the wheel.

When the frame is made to revolve by the revolution of the wagon wheel, the worm will turn both wheels and each will be moved forward one tooth by every turn, and when one hundred turns are made the front wheel will have moved completely around, and the index of its zero graduation will have been carried over one graduation of the inner wheel.

Thus, by noting the position of the indexes of both wheels, the number of revolutions of the wagon wheel can be easily obtained up to ninety-nine hundred, when both wheels will be at zero again. The perimeter of the wagon wheel being known, the number of feet traveled can be at once ascertained by noting the reading of the wheels at the begin-

ning and the end of the journey, subtracting one from the other, and multiplying the perimeter of the wagon wheel by the number of turns made.

The metal box of this Odometer is enclosed in a stout leather case as shown. The opening through which the rectangular frame is inserted or removed, when the reading of the register is desired, is covered with a

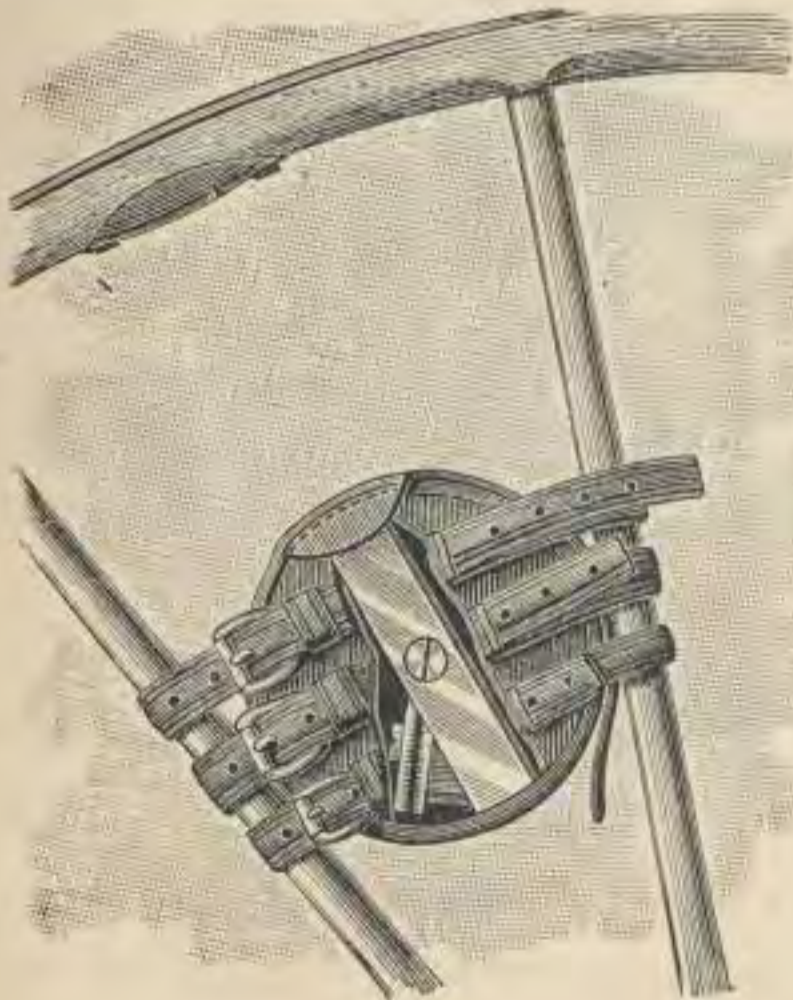

leather flap secured by a strap and buckle, as shown in the cut. The manner in which the Odometer case is attached to the wheel is also shown in the cut.

A form of the Odometer devised by us is represented in the cut, No. 642, the pendulum of which is fastened to a shaft turning in the center of a strong, circular metal box. On this shaft, and turning with it, is a pinion giving motion to a train of wheels, each of which has also a shaft to the end of which an index is fastened.

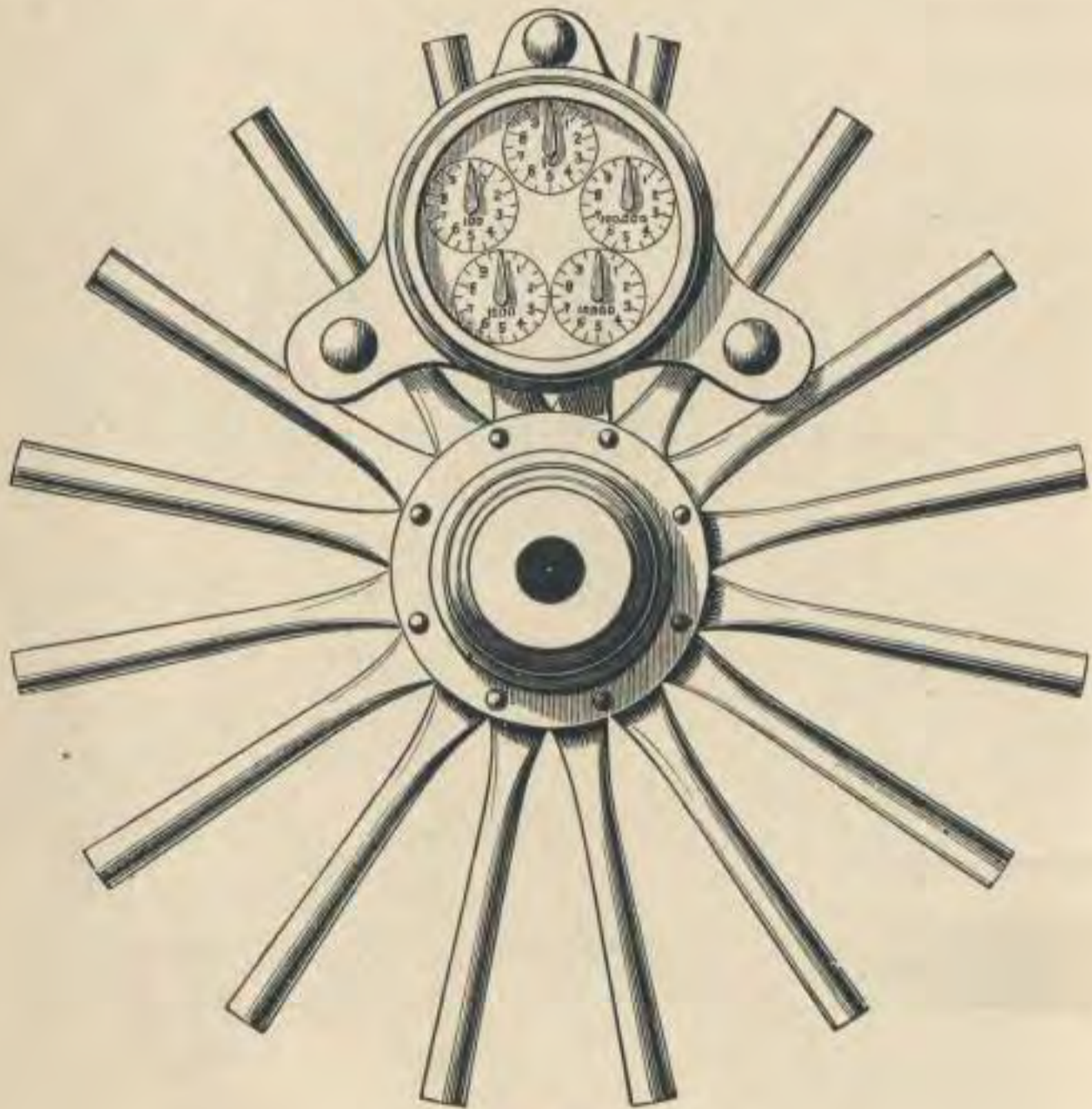

No. 642.

Price, \$10.00.

There are dials for each index as shown, and the number of turns of the wagon wheel can thus be counted up

to one hundred thousand. A thick glass in a strong bezel-ring covers the dials, and allows them to be easily read.

The Odometer is securely fastened to the spokes of the wheel by three carriage bolts as shown, there being also a thick leather washer on each side confined between the bottom of the projecting arms, and a metal washer of the same shape on the other side of the spokes. In using this Odometer, the reading of the dials must be taken at both ends of the journey, the one subtracted from the other, and the remainder showing the number of turns of the wagon wheel multiplied into its perimeter as before described.

POSITIVE MOTION ODOMETER.

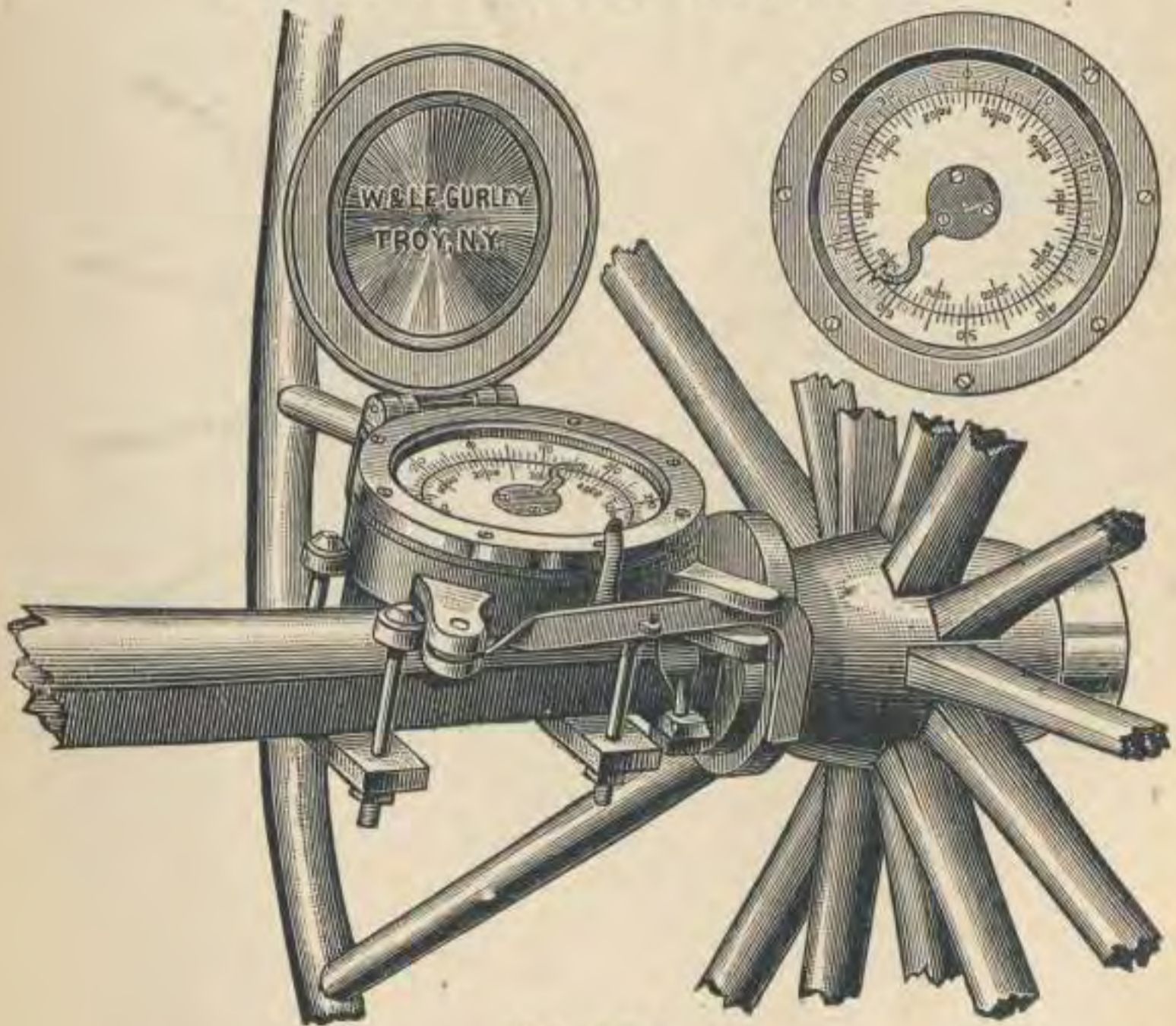

No. 644.

Price, \$20.00. (See page 220.)

The Positive Motion Odometer, shown on page 219, is of the most substantial construction. The wheel work is contained in a solid metal case with glass covering the face of the dial. On the chamfered surface are one hundred graduations, which are figured in tens and read by an index carried forward one space on the dial by every upward movement of a steel lever shown underneath.

A wheel with ninety-nine graduations upon it revolves under the index, immediately beneath the graduated edge of the dial, and is carried forward a single graduation on the dial by every complete revolution of the index. The wheel is figured from 0 to 9,900.

This Odometer is intended to be fastened to the axle of a wagon by the bolts as shown, a cam on the hub of the wheel giving the upward motion to the steel lever. This



cam is not furnished with the Odometer, as it must be made to fit the hub of the wheel, and the cut shown here is for guidance in making the cam. When desired, we will furnish a cam at small extra cost; but we

must first know the dimensions of the hub where the cam is to fit. This form of the Odometer secures entire accuracy in recording the revolutions of the wheel when turning either slow or fast, and has been adopted in the Topographical Surveys of the United States, as being superior to any other.

WHEELBARROW ODOMETER.

An instrument often used in measuring roads and making surveys for county maps is shown in cut No. 646. The wheel is carefully made with brass axle-bearings and tire, the latter having a perimeter of just half a rod. The braces, bolts and all other metal work are also of brass, to avoid any attraction of the magnetic needle.

The upright staff carries a Pocket Vernier Compass with three and one-half-inch needle, by which bearings may be taken at any point desired. The revolutions of the wheel are numbered by the Positive Motion Odometer, fixed to the top of the wooden box, motion being conveyed through a brass rod carried forward by a cam on the axle of the wheel.

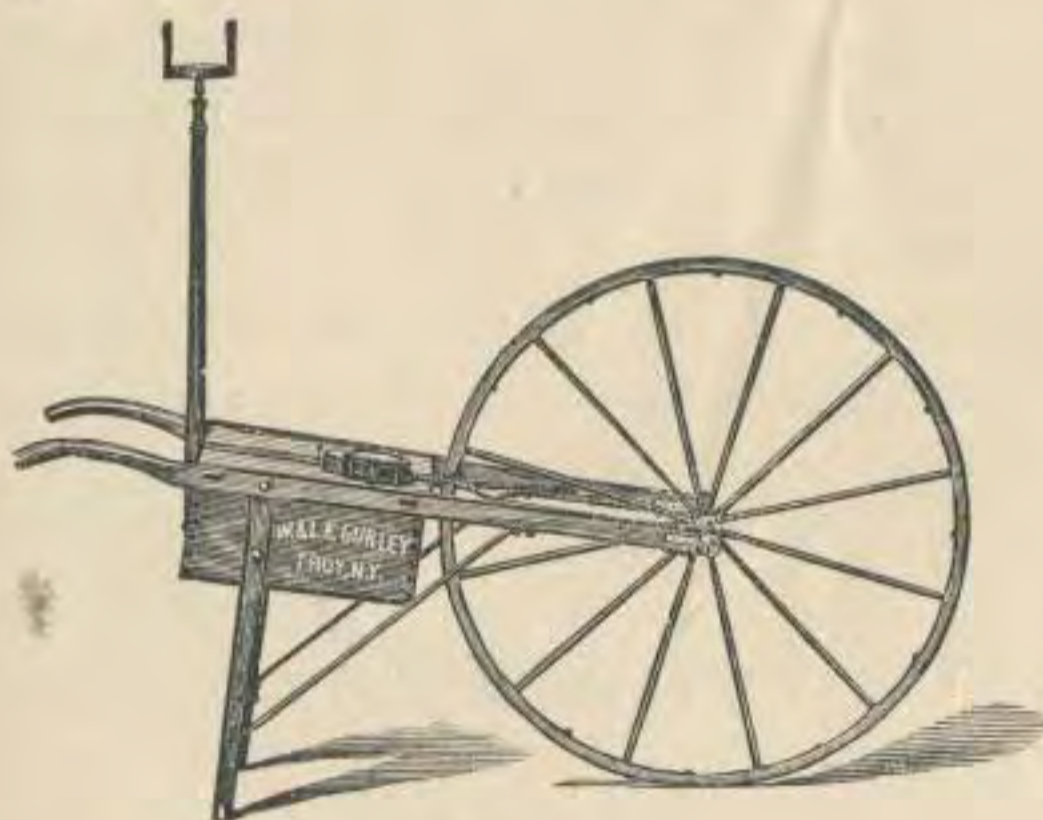

No. 646.

Price, \$120.00.

PRICES.

No.		PRICE.
646.	Wheelbarrow Odometer, complete as shown.....	\$120.00
647.	“ “ “ omitting Compass.....	104.00

LACQUERING.

All instruments are covered with a lacquer applied when the work is heated.

As long as this lacquer remains, the brass surface will be kept from tarnishing, and the Engineer, by taking care not to rub his instrument with a dusty cloth or to expose it to the friction of his clothes, can preserve its original freshness for a long time.

BRONZE FINISH.

Instead of the ordinary brass finish, most Engineers prefer instruments blackened or bronzed. This is done with an acid preparation, after the work has been polished, and gives the instrument a very showy appearance, besides being advantageous on account of not reflecting the rays of the sun as much as the bright or brass finish.

We finish our instruments either bright or bronze, as may be preferred.

If no direction is given, we usually send Transits, Levels and Solar instruments of bronze finish, and Compasses of bright finish.

CHAINS.

The sizes and diameters of iron and steel wire commonly used in making Surveyors' and Engineers' chains are as follows: No. 8, .162-inch; No. 10, .135-inch; No. 12, .105-inch; No. 15, .072-inch; No. 18, .047-inch.

The ordinary GUNTER'S or Surveyors' chain is sixty-six feet or four poles long, composed of one hundred links, each connected to the other by two rings, and furnished with a tally-mark at the end of every ten links. A link in measurement includes a ring at each end, and is seven and ninety-two one-hundredths inches long. In all the chains we manufacture the rings are oval and are sawed and well closed, the ends of the wire forming the hook being also filed and bent close to the link, to avoid the danger of kinking. The oval rings are about one-third stronger than round ones.

The handles are of brass and form part of the end links, to which they are connected by a short link and jam-nuts, by which also the length of the chain is adjusted.

The tallies are of brass, and have one, two, three or four notches, as they mark ten, twenty, thirty or forty links from either end. The fiftieth link is marked by a rounded tally to distinguish it from the others.

In place of the four-pole chain just described, many Surveyors prefer a chain two rods or thirty-three feet long, and having only fifty links, which are counted by tallies from one end in a single direction.

Our Surveyors' chains are made of Nos. 8 and 10 refined iron wire, and of Nos. 8, 10, 12 and 15 best steel wire. Steel chains, though more costly than those of iron, are often preferred on account of their greater strength.

Engineers' chains differ from Surveyors' chains, in that a link including a ring at each end is one foot long, and the wire is of steel and therefore much stronger.

They are either fifty or one hundred feet long, and are furnished with swivel handles and tallies like those just described.

The wire used for these chains is of steel, Nos. 8, 10 and 12 of the first quality.

A very light and strong chain is made of No. 12 steel wire, the links and rings of which are securely brazed. The wire is of a low spring-temper, and the chain though light, is almost incapable of being either broken or stretched in ordinary use.

Our brazed steel chains have been found exceedingly desirable for all kinds of measurement, and for the use of Engineers upon railroads and canals they have almost entirely superseded the heavier chains.

We often make chains with steel snaps in the middle and at one handle. The chain can then be separated, and one handle being removed and transferred to the forty-ninth link, a chain of half length is obtained. This modification is made without charge if ordered with the chain.

TO USE THE CHAIN.

In using the chain the length must be taken from the extreme ends, and the marking-pins placed on the outside

of the handles. It must be drawn straight and taut, and carefully examined to detect any kinks or other causes of inaccuracy.

STANDARD MEASURE. Our chains are all carefully tested at every link and in their whole length, by the U. S. standard, and when new may always be relied upon as correct.

But as all chains will be lengthened more or less after long use in the field, it will be best for the Surveyor to carefully lay down on a level surface the exact length of the chain when new, marking its extreme ends by monuments which will not be liable to disturbance.

He will thus have a standard measure of his own to which the chain can be adjusted from time to time, and again be used with perfect confidence.

GRUMMAN'S PATENT CHAINS.

These chains, invented and patented by J. M. Grumman, of Brooklyn, N. Y., are made of very light steel wire, the links being finely tempered, and, as shown in the cut, so formed at the ends as to fold together readily, and thus dispense with the use of rings.

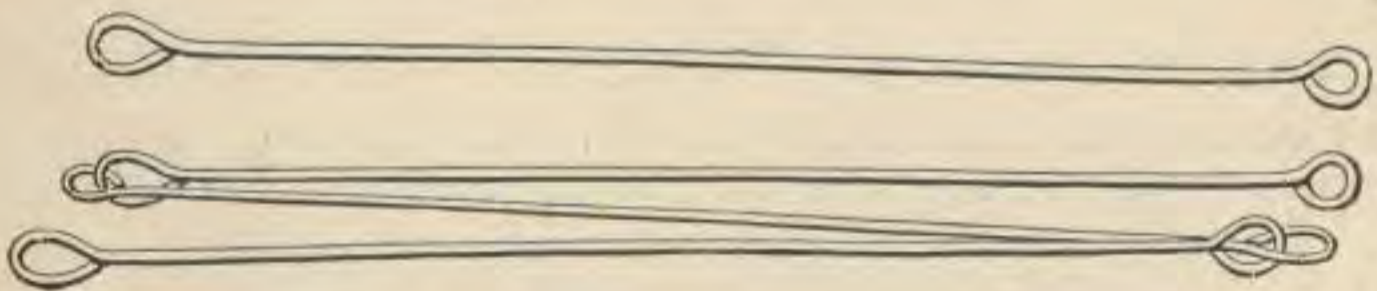

This construction gives but one-third as many wearing points as on the ordinary chain, and affords the utmost facility for repairs.

Five or ten extra links are furnished with each chain, and these have only to be sprung into place to replace

such as may have been broken. The chain can also be sprung apart at any link, and thus be made of any length desired.

Some of these chains are made of No. 15 wire, and are used for measuring on the surface like the ordinary chain. One is used as a suspended chain, for very accurate measurements, and is made of No. 18 wire and provided with spring-balance, level and thermometer attachments. It is held above the surface when in use, and the extremities of the chain are marked upon the ground by the points of plummets let fall from fixed places on the chain.

VARA CHAINS.

The vara, which is in general use in Texas, is **33.333** inches long. The chains are made both of iron and steel wire, ten or twenty varas in length, each vara being usually divided into five links. A link, including a ring at each end, is therefore **6.666** inches long. A ten-vara chain has fifty links; a twenty-vara chain one hundred links. Each vara is marked by a round brass tally, numbered from one to nine in the ten-vara chain, and from one to nineteen in the twenty-vara chain.

METER CHAINS.

The meter is used as a standard measure of length in many countries, and chains of ten and twenty meters are often ordered. The chains are made of iron or steel wire, each meter being divided into five links; a meter being **39.371** inches long, a link, including a ring at each end, is therefore **7.874** inches long.

A ten-meter chain has fifty links and a twenty-meter chain one hundred links. Each meter is marked with a round brass tally numbered from one to nine in the ten-

meter chain and from one to nineteen in the twenty-meter chain.

MARKING-PINS.

In chaining, eleven marking-pins are needed, made either of iron, steel or brass wire, as may be preferred, about fourteen inches long, pointed at one end to enter the ground, and formed into a ring at the other end for convenience in handling.

• Marking-pins are sometimes loaded with a little mass of lead around the lower end, to answer as a plumb when dropped to the ground from the suspended end of the chain.

CHAIN-TAPES.

Chain-tapes are made of a thin ribbon of steel, about one-quarter of an inch wide, and of straight spring-temper. They are usually made in lengths of thirty-three to five hundred feet; and are generally used on bridge, road and street work, and also as standards for comparison of other chains and tapes.

The thirty-three and sixty-six feet lengths are usually graduated at each Gunter's link for use in land-surveying; and the fifty and one hundred feet lengths are graduated at each foot, and also have the first and last foot marked in tenths for city work. See Price-List, Nos. 760-767.



No. 760.

A simple and convenient reel for these tapes is shown in the above cut. The handle of the drum when not in

use can be folded flat, and a small projection at its base fits into a slot made to receive it, and thus clamps the drum and prevents the tape from unwinding.

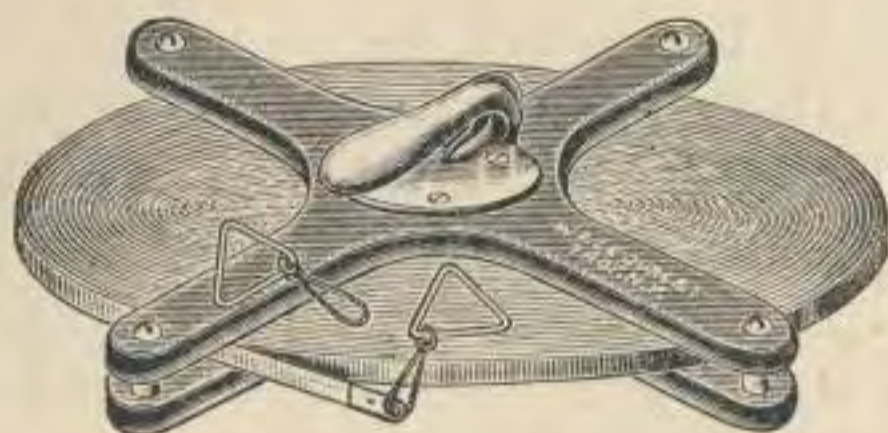

No. 770.

The longer tapes, from three hundred to five hundred feet in length, are usually graduated at each five feet, and also have the first and last five feet marked at each foot. They are wound upon a substantial wooden reel, with aluminum and brass mountings, as shown above. See Price-List, Nos. 770-772.

METALLIC TAPES.

These are of linen, about five-eighths of an inch wide, and have fine brass wires interwoven through their whole length. They are thus measurably correct, even when wet.

They are graduated in feet and tenths of feet or in feet and inches, on one side, as ordered, and are also marked in links on the reverse side. They are wound up in a leather case having a folding handle. See Price-List, Nos. 780-794.

STEEL TAPES.

The best tapes are made of a thin ribbon of steel in one piece, of straight spring-temper, and either one-quarter, three-eighths or one-half of an inch wide.

These tapes are of all lengths from twenty-five to one hundred feet, graduated into feet and inches, and links on the reverse side, or more usually, feet and tenths of a foot, and links on the reverse side, the figures and graduations being raised on the surface of the steel.

Paine's American steel tapes are made of thin steel ribbon, straight spring-temper, in one piece, and about one-quarter of an inch wide. They can be detached from the case when desired, and used with a pair of handles with compensation-scale for variations of temperature, for chain measurements.

Paine's tapes are U. S. Standard measure at 62° temperature, and using about twelve pounds strain. A hundred-foot tape expands .0756 inch for each 10° rise in temperature.

These tapes are wound up in a leather or metal case, as may be desired, having a folding handle. See Price-List, Nos. 800-835.

Our Excelsior steel tape, one half inch wide and mounted on an open brass frame with folding handle, is well liked for use in mines.

The tape is easily wound up and unwound, and the open frame allows moisture to evaporate. See Price-List, Nos. 850-858.

METRIC AND VARA TAPES.

When desired, we can furnish any of our metallic tapes, Nos. 780-794, and steel tapes, Nos. 800-835, with metric or vara graduations on the reverse side, instead of links, at extra prices as quoted on pages 273 and 275 ; and with metric or vara measure only, at prices of regular styles of similar lengths in feet. Our chain-tapes, Nos. 760-772, are also graduated with metric measure only (when so ordered), and are marked at each meter with the first and last meter in decimeters.

INFORMATION TO PURCHASERS.

SELECTION OF INSTRUMENTS.

FOR original surveys, or ascertaining the bearing of lines in the preparation of county maps, the PLAIN COMPASS will answer.

The VERNIER COMPASS, or VERNIER TRANSIT-COMPASS, will be required where allowance must be made for the variation of the needle, as in retracing the lines of an old survey.

When local attraction must be taken into account, in addition to the variation of the needle, and angles taken independently of the needle, an instrument with a graduated limb must be used, and for this purpose the RAILROAD COMPASS will be sufficient.

For a mixed practice of general surveying, including farm and city work, the establishment of grades of roads and the running of levels, such an instrument as the SURVEYORS' TRANSIT, with its various attachments, is amply sufficient.

The various forms of the ENGINEERS' TRANSIT, the MOUNTAIN TRANSIT, and the Y-LEVELING-INSTRUMENTS, are designed for engineering of the highest class.

In the U. S. Public Land surveys, an instrument with Solar Attachment is required, and the SOLAR TRANSIT is usually selected.

In surveys of mining claims, especially in high elevations, and for the surveys of mines in general, the MOUNTAIN TRANSIT, with the Solar Attachment and with other extras, has proved a universal favorite.

The DRAINAGE LEVEL is, we believe, the most simple and efficient instrument designed for laying out drains and similar work.

The ARCHITECTS' LEVEL and the BUILDERS' TRANSIT are used in laying out buildings, determining the level of their floors, sills and windows, and in the general work of the builder.

The RECONNOISSANCE TRANSIT and the various forms of POCKET COMPASSES, with or without telescopic attachment, are very desirable for a large class of work where extreme lightness and portability are desirable.

Where iron ores are to be traced, the MINERS' DIP-COMPASS, the DIAL COMPASS and the POCKET SOLAR COMPASS are used. We do not pretend to make any instrument by which veins of gold and silver can be traced, or the presence of these metals detected.

Our instruments are not carried in stock by merchants; and we do not deem it advisable to add to our prices in order to enable us to give to merchants a large discount, which of course would be paid by the purchaser.

WARRANTY.

All our instruments are examined and tested by us in person, and are sent to the purchaser adjusted and ready for immediate use.

When purchased directly from us, they are warranted correct in all their parts,—we agreeing, in the event of any defect appearing after reasonable use, to repair or replace with a new and perfect instrument, promptly and at our own cost, express charges included; or we will refund the money and the express charges paid by the customer.

Instances sometimes occur, in a business as large and widely extended as ours, where, owing to careless trans-

portation or to defects escaping the closest scrutiny of the maker, instruments reach our customers in bad condition. We consider the retention of such instruments in all cases an injury very much greater to us than to the customer himself.

TRIAL OF INSTRUMENTS.

It may happen that this statement will come into the hands of those who are entirely unacquainted with us or the quality of our work, and who therefore feel unwilling to purchase an instrument of the excellence of which they are not perfectly assured.

To such we make the following proposition: If requested to do so, we will send the instrument to the express-station nearest the purchaser, and direct the Express Agent, on delivery, to collect our bill, together with the charges for transportation, and hold the money on deposit one or two weeks, if desired, until the purchaser shall have had an actual trial of the instrument.

If not found as represented, the purchaser may return the instrument before the expiration of the specified time, and receive the money paid in full, including express charges, and direct the instrument to be returned to us.

This privilege of trial applies only to our larger Transits, Levels and Compasses, and is not given unless requested, and is allowed only in the United States.

EXTENT OF OUR BUSINESS.

Thousands of our instruments are now in use in North and South America and in many other countries.

Our facilities for manufacturing, which, for many years, have been far superior to those of any other similar establishment, are constantly being increased by the introduction of new machinery and tools.

We make under our own roof the lenses for the telescopes of our instruments, the glass vials for the level-tubes, the wooden boxes in which the instruments are packed, the leather cases and straps for these boxes, as well as all the metal parts of the instruments themselves.

LOW PRICES OF OUR INSTRUMENTS.

It is often stated that it is impossible to make first-rate instruments at our prices, which are far below those of other skilful manufacturers. To this we can only reply that a visit to our works and a comparison of our facilities with those of any manufacturer will dispel all doubts as to our ability to furnish the best instruments for the money that can be produced in this country.

PACKING.

Each of our Transits, Levels and Surveyors' Compasses is packed in a well-finished mahogany case, furnished with lock and key and brass hooks, and leather strap for convenience in carrying. Each case is provided with screw-driver, adjusting-pin and wrench for center-pin, and, if accompanied by a tripod, with a brass plummet. With all the instruments used for taking angles without the needle, a reading-glass is also furnished.

Unless the purchaser is already supplied, each instrument is accompanied by our Manual, giving full instruction for such adjustments and repairs as are possible to one not provided with the facilities of an instrument-maker.

When sent to the purchaser, the mahogany cases are carefully enclosed in outside packing-boxes of pine, made a little larger on all sides to allow the introduction of elastic material; and so effectually are our instruments protected by these precautions, that of many thousands sent

out since 1845, in all seasons, by every mode of transportation, and to all parts of the world, very few have sustained any serious injury.

Instruments packed for foreign shipment, which are to have ocean passage, are hermetically sealed in tin cases.

MEANS OF TRANSPORTATION.

Instruments can be sent by express to almost every town in the United States, Canada and Mexico, regular agents being located at all the more important points, by whom they are forwarded to smaller places by stage.

The charges for transportation are in all cases to be borne by the purchaser, we guaranteeing the safe arrival of our instruments at his express-office, and holding the Express Company responsible to us for all loss and damage on the way.

FINISH OF INSTRUMENTS.

We now send Transits and Levels with bronze or black finish and Compasses with bright finish, unless otherwise ordered.

TERMS OF PAYMENT.

Our terms of payment are uniformly cash, and we have but one price, whether ordered in person, by mail or telegraph. Our prices are as low as instruments of first quality can be made.

Remittances may be made by a cashier's draft payable to our order, which can be procured from banks or bankers in almost all the larger villages, or by Express Company or Post-office money-orders. These may be sent by mail with the order for the instrument, and if lost or stolen

on the way can be replaced by a duplicate obtained as before, without additional cost. The customer may also send the money in advance by registered mail or by the express agent, or may pay the agent on receipt of the instrument in funds current in New York.

Customers ordering instruments and desiring changes in construction from our regular patterns must make a payment in advance, when ordering, of fifty per cent. of the price.

The cost of returning the money on bills of amounts under \$20, collected by express, will be charged to the customer.

When articles are to be sent by mail, payment must be made in advance, including the cost of postage. The postage required is mentioned in the second column of the Price-List.

INSTRUMENTS FOR FOREIGN COUNTRIES.

We send Civil Engineers' and Surveyors' instruments to Canada, Mexico, Central America, Cuba, South America, China, Japan, Australia, Africa and India, as well as to various parts of Europe.

The cash for all orders for foreign shipments by steamship must, in every case, accompany the order, and if it is desired that we attend to the shipment of the instruments, the remittance must be made ten per cent. more than the catalogue price of the instruments if the order amounts to \$250 or less, or eight per cent. more than the catalogue price if the order amounts to from \$300 to \$500, or six per cent. more than the catalogue price if the order amounts to from \$600 to \$1,000.

This extra remittance is to cover cost of shipping-charges, freight and insurance, which must always be paid

in advance on all shipments except those to Canada and some parts of Mexico.

If the amount remitted is more than enough to cover these expenses, any balance will be returned to the purchaser with the receipted bill and bill of lading, unless we are directed to hold it to his credit and subject to his order.

Remittances must be made by bankers' draft on London, England, or on New York City, and such drafts can be purchased in any of the large cities of the countries named.

ALUMINUM.

For twenty years we have been making Civil Engineers' and Surveyors' instruments of aluminum, to order only. The only advantage which instruments of aluminum have over those of the ordinary metals is their light weight; but as all the bearing parts must be made of bronze, the total weight can be reduced only about fifty per cent. We finish our aluminum instruments in the natural color, and the result is more satisfactory from an artistic standpoint than when an artificial coloring is used, although it entails much extra expense. We will quote prices on application for any of our instruments of regular pattern made of aluminum.

REPAIR OF INSTRUMENTS.

Every year we receive nearly a thousand instruments of our own and others' make, sent to us for refitting and repairs. Most of them have been injured by falls, many have parts worn and defective after long use; and others are sent for repolishing and renovating.

We advise our customers who have instruments in need of repairs to send them directly to us, as our facilities enable us to do the work much more economically and promptly than any other maker, however accessible.

The instruments should always, when practicable, be placed in their own boxes, and then enclosed in an outside packing-case, an inch larger in all its dimensions, that the space between the two may be filled with paper wadding, hay or fine shavings. The owner's name and address, together with a note specifying the repairs needed, should always accompany the instrument, and a letter should also be sent to us by mail, giving not only directions as to the repairs, but also stating when the return of the instrument is desired, and the address to which it should be forwarded.

It should also be remembered that each instrument is made to fit its own spindle, and no other; and therefore this part, with the parallel plates and leveling-screws if it has them, should always be sent with it. The tripod legs and the head in which they are inserted need not be sent, unless in need of repairs. When requested to do so, we will send an estimate of the cost of repairs on any instrument sent us, before beginning the work.

Compasses come to us with the plates sprung, the sights bent or broken, the glass or level-vials fractured, and the pivot so dulled as to render the needle sluggish and unreliable. The cost of repairing these defects ranges from \$2 to \$10. A pair of new sights fitted costs \$5; a new needle with jeweled-center and pivot complete, \$3; a new jeweled-center only, \$1.50; regrading compass-circle, \$5.

The Compass should always be accompanied with the ball-spindle, and if a new ball-spindle is required, the whole instrument, or at least the socket in which the spindle fits, should be forwarded to us. A new ball-spindle, fitted, costs \$2. See, also, page 240.

Repairs to Railroad Compasses cost from \$10 to \$20, and to Solar Compasses from \$20 to \$50.

The injuries which Engineers' and Surveyors' Transits sustain by falls are usually much more serious; the plates, standards and cross-bars of telescopes are often bent, and sockets or centers are usually so deranged as to be entirely useless.

REPAIRS TO TRANSITS.

The cost of repairing an instrument with such injuries ranges from \$10 to \$30, or even \$50, new sockets alone costing from \$15 to \$20. See, also, page 240.

Variation plate added to an Engineers' Transit sent for repairs, costs.....	\$15.00
Regraduating horizontal limb and vernier to read to one minute, costs.....	10.00
Regraduating vertical limb and vernier to read to one minute, costs.....	5.00

No one but a workman with practised hand and provided with the best facilities can properly set the platinum wires in a cross-wire diaphragm, and it is useless, therefore, for us to send a parcel of wires for that purpose.

PLATINUM CROSS-WIRES.

The only way in which they can be replaced without sending the telescope to us is to take out the ring and send it with its screws, washers, etc., and we will return it with the wires properly secured.

Plain platinum cross-wires, replaced on the old ring, cost	\$2.00
Adjustable platinum stadia-wires, replaced on the old ring, cost.....	3.00
Fixed, platinum stadia-wires, replaced on the old ring, cost.....	5.00

If sent by mail, add 15 cents for postage and registry, and 25 cents for a safety brass packing-box.

We are not responsible for wires sent in this way and broken while inserting the ring in the telescope. The best plan is to send us the telescope when new cross-wires are needed.

When it is desirable to substitute platinum for spider-web, a new ring with screws will be required, and the telescope should be sent to us.

Plain platinum cross-wires, with diaphragm, screws, etc., cost	\$3.00
Adjustable platinum stadia-wires, with diaphragm, screws, etc., cost.....	5.00
Fixed platinum stadia-wires, with diaphragm, screws, etc., cost	7.00

(See, also, pages 10 and 11.)

Leveling-instruments are generally much less injured by **REPAIRS TO LEVELS.** falls than Transits. The damages are usually the bending of the bar, the springing of the sockets, and the breaking of the vial.

The cost of repairs varies from \$5 to \$20 ; a new level-vial set in the old tube costs \$2. See, also, page 241.

REPOLISHING INSTRUMENTS. The cost of repolishing an instrument varies, but may be stated generally as follows :

COMPASSES, Plain and Vernier.....	\$ 5.00 to \$ 7.00
RAILROAD COMPASSES.....	8.00 to 10.00
SOLAR COMPASSES, large size.....	12.00 to 15.00
TRANSITS.....	12.00 to 15.00
Y-LEVELS	8.00 to 12.00

It must be understood that these prices are in addition to the cost of adjustment and of any necessary repairs.

No additional charge is made for bronzing or blackening an instrument when repolished.

Payment for repairs may be made at the Express-Office where the instrument is received, the customer paying for the first transportation of the instrument to us **PAYMENT.** or not, as he may prefer. Whenever the charges are paid in advance, the express receipt should be mailed directly to us.

W. & L. E. GURLEY,
 Mathematical Instrument Makers,
 514 Fulton St., Opposite North End of Union R. R. Depot,
 Troy, N. Y., U. S. A.

PRICES FOR PARTS OF INSTRUMENTS LIABLE TO LOSS OR INJURY.

FOR TRANSITS.

	PRICE.	POST.
Needle with jeweled-center and center-pin.....	\$3.00	\$0.10
Center-pin only.....	.50	.01
Ground glass level-vial for plate or standard, each.....	.35	.02
Ground glass level-vial, brass mounted complete, for plate or standard, each.....	2.00	.12
Ground glass level-vial for telescope, each.....	1.25	.12
Cap for eyepiece or object-glass, each.....	.75	.03
Shade for object-glass.....	.75	.03
Clamp-screws for horizontal limb, each.....	.75	.02
Tangent screw for leveling-head.....	\$0.75 to 1.50	.11
Clamp-screw for leveling-head.....	.75	.03
Leveling-screw for leveling-head, each.....	\$1.00 to 1.50	.12
Eyepiece complete.....	6.00	.12
Object-glass complete.....	6.00	.12
Platinum cross-wires and diaphragm.....	3.00	.15
Platinum stadia wires, adjustable, and diaphragm.....	5.00	.15
Platinum stadia wires, fixed, and diaphragm.....	7.00	.15
Mahogany box with lock and strap, and fitted inside.....	\$4 to \$6	

FOR SURVEYORS' COMPASSES.

Needle with jeweled-center and center-pin.....	\$3.00	\$0.10
Center-pin only.....	.50	.01
Plain glass level-vials, each.....	.12	.02
Plain glass level-vials, brass mounted complete, each.....	1.50	.12
Brass cover for Compass of our make.....	1.00	.25
Outkeeper.....	1.00	.11
Glass circle for compass-face.....	.25	.15
Wrench for center-pin.....	.10	.01
Staff mountings, brass head, without spindle.....	2.00	.25
Staff mountings, steel point.....	.50	.18
Ball-spindle, fitted to old socket.....	2.00	.30
Compass sight-vanes, each.....	2.50	.20
Clamp-screw for spindle or sight-vane.....	.50	.03
Tangent screw for moving vernier.....	1.50	.10
Staff mountings complete for Pocket-Compass, small.....	2.50	.15
Staff mountings complete for Pocket-Compass, large.....	3.50	.20
Mahogany box with lock and strap, and fitted inside.....	\$4 to \$6	

FOR Y-LEVELS.

	PRICE.	POST.
Ground glass level-vial, unmounted, for 22-inch Y-Level...	\$1.85	\$0.15
Ground glass level-vial, unmounted, for 15-20-inch Y-Levels	1.65	.15
Ground glass level-vial, unmounted, for Architects' Level..	.90	.05
Cap for eyepiece or object-glass, each75	.03
Clamp-screw for leveling-head.....	.75	.03
Tangent screw for leveling-head	\$0.75 to 1.50	.11
Leveling-screw for leveling-head, each.....	1.00 to 1.50	.12
Eyepiece complete.....	6.00	.12
Object-glass complete	7.00	.12
Platinum cross-wires and diaphragm.....	3.00	.15
Platinum stadia wires, adjustable, and diaphragm.....	5.00	.15
Platinum stadia wires, fixed, and diaphragm.....	7.00	.15
Mahogany box with lock and strap, and fitted inside.....	\$4.50 to \$6.	

MISCELLANEOUS.

Plain tripod legs only, for Engineers' Transit or Level, per set.....	\$ 5.00	
Split tripod legs only, for Engineers' Transit or Level, per set.....	7.00	
Extension tripod legs only, for Engineers' Transit or Level, per set.....	10.00	
Clamp-screw and band for extension leg, each85	\$0.05
Tripod head only, with bolts and nuts, for Engineers' Transit or Level.....	5.00	.50
Wooden cap with brass screw-plate, to fit tripod head, each	.75	.12
Brass bolt and nut to fit tripod head, each50	.05
Metal point or shoe for tripod leg, each.....	.50	.05
Leather ring to bind tripod legs together, each.....	.10	.02
Steel screw-driver with wooden handle, each15	.03
Steel adjusting-pins, each.....	.05	.01
Rubber tips, for bottom of instrument-box, per set.....	.40	.05
Reading-glass, for Transit, each.....	.75	.02
Brass Plummet with screw cap, for Transit or Level, each..	1.50	.20
Waterproof rubber hood, for Transit or Level, each.....	1.00	.12
Chamois skin, large size, best quality, each.....	.65	.05
Clamp with clamp-screw, for New York rod	2.00	.15
Clamp with scale and clamp-screw, for Philadelphia rod...	2.50	.15
Target with clamp-screw and spring, for New York or Philadelphia rod	5.00	.35
Chain handle, with staple and nuts, each.....	.75	.08
Chain tallies, per set of 9.....	.50	.06

TRAVERSE-TABLES.

TRAVERSE-TABLE.

Course.	Dist. 1.		Dist. 2.		Dist. 3.		Dist. 4.		Dist. 5.		Course.
	Lat.	Dep.	Lat.	Dep.	Lat.	Dep.	Lat.	Dep.	Lat.	Dep.	
0 15	1.0000	0.0044	2.0000	0.0087	3.0000	0.0131	4.0000	0.0175	5.0000	0.0218	89 45
30	0000	0087	1.9999	0175	2.9999	0262	3.9998	0349	4.9998	0436	30
45	0.9999	0131	9998	0262	9997	0393	9997	0524	9996	0654	15
1 0	9998	0175	9997	0349	9995	0524	9994	0698	9992	0873	89 0
15	9998	0218	9995	0436	9993	0654	9990	0873	9988	1091	45
30	9997	0262	9993	0524	9990	0785	9986	1047	9983	1309	30
45	9995	0305	9991	0611	9986	0916	9981	1222	9977	1527	15
2 0	9994	0349	9988	0698	9982	1047	9976	1396	9970	1745	88 0
15	9992	0393	9985	0785	9977	1178	9969	1570	9961	1963	45
30	9990	0436	9981	0872	9971	1309	9962	1745	9952	2181	30
45	0.9988	0.0480	1.9977	0.0960	2.9965	0.1439	3.9954	0.1919	4.9942	0.2399	15
3 0	9986	0523	9973	1047	9959	1570	9945	2093	9931	2617	87 0
15	9984	0567	9968	1134	9952	1701	9936	2268	9920	2835	45
30	9981	0610	9963	1221	9944	1831	9925	2442	9907	3052	30
45	9979	0654	9957	1308	9936	1962	9914	2616	9893	3270	15
4 0	9976	0698	9951	1395	9927	2093	9903	2790	9878	3488	86 0
15	9973	0741	9945	1482	9918	2223	9890	2964	9863	3705	45
30	9969	0785	9938	1569	9908	2354	9877	3138	9846	3923	30
45	9966	0828	9931	1656	9897	2484	9863	3312	9828	4140	15
5 0	9962	0872	9924	1743	9886	2615	9848	3486	9819	4358	85 0
15	0.9958	0.0915	1.9916	0.1830	2.9874	0.2745	3.9832	0.3660	4.9790	0.4575	45
30	9954	0958	9908	1917	9862	2875	9816	3834	9770	4792	30
45	9950	1002	9899	2004	9849	3006	9799	4008	9748	5009	15
6 0	9945	1045	9890	2091	9836	3136	9781	4181	9726	5226	84 0
15	9941	1089	9881	2177	9822	3266	9762	4355	9703	5443	45
30	9936	1132	9871	2264	9807	3396	9743	4528	9679	5660	30
45	9931	1175	9861	2351	9792	3526	9723	4701	9653	5877	15
7 0	9925	1219	9851	2437	9776	3656	9702	4875	9627	6093	83 0
15	9920	1262	9840	2524	9760	3786	9680	5048	9600	6310	45
30	9914	1305	9829	2611	9743	3916	9658	5221	9572	6526	30
45	0.9909	0.1349	1.9817	0.2697	2.9726	0.4046	3.9635	0.5394	4.9543	0.6743	15
8 0	9903	1392	9805	2783	9708	4175	9611	5567	9513	6959	82 0
15	9897	1435	9793	2870	9690	4305	9586	5740	9483	7175	45
30	9890	1478	9780	2956	9670	4434	9561	5912	9451	7390	30
45	9884	1521	9767	3042	9651	4564	9534	6085	9418	7606	15
9 0	9877	1564	9754	3129	9631	4693	9508	6257	9384	7822	81 0
15	9870	1607	9740	3215	9610	4822	9480	6430	9350	8037	45
30	9863	1650	9726	3301	9589	4951	9451	6602	9314	8252	30
45	9856	1693	9711	3387	9567	5080	9422	6774	9278	8467	15
10 0	9848	1736	9696	3473	9544	5209	9392	6946	9240	8682	80 0
15	0.9840	0.1779	1.9681	0.3559	2.9521	0.5338	3.9362	0.7118	4.9202	0.8897	45
30	9833	1822	9665	3645	9498	5467	9330	7289	9163	9112	30
45	9825	1865	9649	3730	9474	5596	9298	7461	9123	9326	15
11 0	9816	1908	9633	3816	9449	5724	9265	7632	9081	9540	79 0
15	9808	1951	9616	3902	9424	5853	9231	7804	9039	9755	45
30	9799	1994	9598	3987	9398	5981	9197	7975	8996	9968	30
45	9790	2036	9581	4073	9371	6109	9162	8146	8952	1.0182	15
12 0	9781	2079	9563	4158	9344	6237	9126	8316	8907	0396	78 0
15	9772	2122	9545	4244	9317	6365	9089	8487	8862	0609	45
30	9763	2164	9526	4329	9289	6493	9052	8658	8815	0822	30
45	0.9753	0.2207	1.9507	0.4414	2.9260	0.6621	3.9014	0.8828	4.8767	1.1035	15
13 0	9744	2250	9487	4499	9231	6749	8975	8998	8719	1248	77 0
15	9734	2292	9468	4584	9201	6876	8935	9168	8669	1460	45
30	9724	2334	9447	4669	9171	7003	8895	9338	8618	1672	30
45	9713	2377	9427	4754	9140	7131	8854	9507	8567	1884	15
14 0	9703	2419	9406	4838	9109	7258	8812	9677	8515	2096	76 0
15	9692	2462	9385	4923	9077	7385	8769	9846	8462	2308	45
30	9681	2504	9363	5008	9044	7511	8726	1.0015	8407	2519	30
45	9670	2546	9341	5092	9011	7638	8682	0184	8352	2730	15
15 0	9659	2588	9319	5176	8978	7765	8637	0353	8296	2941	75 0

Dep. Lat. Dist. 1. Dep. Lat. Dist. 2. Dep. Lat. Dist. 3. Dep. Lat. Dist. 4. Dep. Lat. Dist. 5. Course.

Course.	Dist. 6.		Dist. 7.		Dist. 8.		Dist. 9.		Dist. 10.		Course.
	Lat.	Dep.	Lat.	Dep.	Lat.	Dep.	Lat.	Dep.	Lat.	Dep.	
0 15	5.9999	0.0262	6.9999	0.0305	7.9999	0.0349	8.9999	0.0393	9.9999	0.0436	89 45
30	9998	0524	9997	0611	9997	0698	9997	0785	9996	0873	30
45	9995	0785	9994	0916	9993	1047	9992	1178	9991	1309	15
1 0	9991	1047	9989	1222	9988	1396	9986	1571	9985	1745	89 0
15	9986	1309	9983	1527	9981	1745	9979	1963	9976	2181	45
30	9979	1571	9976	1832	9973	2094	9969	2356	9966	2618	30
45	9972	1832	9967	2138	9963	2443	9958	2748	9953	3054	15
2 0	9963	2094	9957	2443	9951	2792	9945	3141	9939	3490	88 0
15	9954	2356	9946	2748	9938	3141	9931	3533	9923	3926	45
30	9943	2617	9933	3053	9924	3490	9914	3926	9905	4362	30
45	5.9931	0.2879	6.9919	0.3358	7.9908	0.3838	8.9896	0.4318	9.9885	0.4798	15
3 0	9918	3140	9904	3664	9890	4187	9877	4710	9863	5234	87 0
15	9904	3402	9887	3968	9871	4535	9855	5102	9839	5669	45
30	9888	3663	9869	4273	9851	4884	9832	5494	9813	6105	30
45	9872	3924	9850	4578	9829	5232	9807	5886	9786	6540	15
4 0	9854	4185	9829	4883	9805	5581	9781	6278	9756	6976	86 0
15	9835	4447	9808	5188	9780	5929	9753	6670	9725	7411	45
30	9815	4708	9784	5492	9753	6277	9723	7061	9692	7846	30
45	9794	4968	9760	5797	9725	6625	9691	7453	9657	8281	15
5 0	9772	5229	9734	6101	9696	6972	9658	7844	9619	8716	85 0
15	5.9748	0.5490	6.9706	0.6405	7.9664	0.7320	8.9622	0.8235	9.9580	0.9150	45
30	9724	5751	9678	6709	9632	7068	9586	8626	9540	9585	30
45	9698	6011	9648	7013	9597	8015	9547	9017	9497	1.0019	15
6 0	9671	6272	9617	7317	9562	8362	9507	9408	9452	0453	84 0
15	9643	6532	9584	7621	9525	8709	9465	9798	9406	0887	45
30	9614	6792	9550	7924	9486	9056	9421	1.0188	9357	1320	30
45	9584	7052	9515	8228	9445	9403	9376	0578	9307	1754	15
7 0	9553	7312	9478	8531	9404	9750	9329	0968	9255	2187	83 0
15	9520	7572	9440	8834	9360	1.0096	9280	1358	9200	2620	45
30	9487	7832	9401	9137	9316	0442	9230	1747	9144	3053	30
45	5.9452	0.8091	6.9361	0.9440	7.9269	1.0788	8.9178	1.2137	9.9087	1.3485	15
8 0	9416	8350	9319	9742	9221	1134	9124	2526	9027	3917	82 0
15	9379	8610	9276	1.0044	9172	1479	9069	2914	8965	4349	45
30	9341	8869	9231	0947	9121	1825	9011	3303	8902	4781	30
45	9302	9127	9185	0649	9069	2170	8953	3691	8836	5212	15
9 0	9261	9386	9138	0950	9015	2515	8892	4079	8769	5643	81 0
15	9220	9645	9090	1252	8960	2859	8830	4467	8700	6074	45
30	9177	9903	9040	1553	8903	3204	8766	4854	8629	6505	30
45	9133	1.0161	8989	1854	8844	3548	8700	5241	8556	6935	15
10 0	9088	0419	8937	2155	8785	3892	8633	5628	8481	7365	80 0
15	5.9042	1.0677	6.8883	1.2456	7.8723	1.4235	8.8564	1.6015	9.8404	1.7794	45
30	8995	0934	8728	2756	8660	4579	8493	6401	8325	8224	30
45	8947	1191	8772	3057	8596	4922	8421	6787	8245	8652	15
11 0	8898	1449	8714	3357	8530	5265	8346	7173	8163	9081	79 0
15	8847	1705	8655	3656	8463	5607	8271	7558	8079	9509	45
30	8795	1962	8595	3956	8394	5949	8193	7943	7992	9937	30
45	8743	2219	8533	4255	8324	6291	8114	8328	7905	2.0364	15
12 0	8689	2475	8470	4554	8252	6633	8033	8712	7815	0791	78 0
15	8634	2731	8406	4852	8178	6974	7951	9096	7723	1218	45
30	8578	2986	8341	5151	8104	7315	7867	9480	7630	1644	30
45	5.8521	1.3242	6.8274	1.5449	7.8027	1.7656	8.7781	1.9863	9.7534	2.2070	15
13 0	8462	3497	8206	5747	7950	7996	7693	2.0246	7437	2495	77 0
15	8403	3752	8137	6044	7870	8336	7604	0628	7338	2920	45
30	8342	4007	8066	6341	7790	8676	7513	1010	7237	3345	30
45	8281	4261	7994	6638	7707	9015	7421	1392	7134	3769	15
14 0	8218	4515	7921	6935	7624	9354	7327	1773	7030	4192	76 0
15	8154	4769	7846	7231	7538	9692	7231	2154	6923	4615	45
30	8089	5023	7770	7527	7452	2.0030	7133	2534	6815	5038	30
45	8023	5276	7693	7822	7364	0368	7034	2914	6705	5460	15
15 0	7956	5529	7615	8117	7274	0706	6933	3294	6593	5882	75 0

Dep. Lat.
Dist. 6.

Dep. Lat.
Dist. 7.

Dep. Lat.
Dist. 8.

Dep. Lat.
Dist. 9.

Dep. Lat.
Dist. 10.

Course.

Course.	Dist. 1.		Dist. 2.		Dist. 3.		Dist. 4.		Dist. 5.		Course.
	Lat.	Dep.	Lat.	Dep.	Lat.	Dep.	Lat.	Dep.	Lat.	Dep.	
15 15	0.9648	0.2630	1.9296	0.5261	2.8944	0.7891	3.8591	1.0521	4.8239	1.3152	74 45
30	9636	2672	9273	5345	8909	8017	8545	0690	8182	3362	30
45	9625	2714	9249	5429	8874	8143	8498	0858	8123	3572	15
16 0	9613	2756	9225	5513	8838	8269	8450	1025	8063	3782	74 0
15	9600	2798	9201	5597	8801	8395	8402	1193	8002	3991	45
30	9588	2840	9176	5680	8765	8520	8353	1361	7941	4201	30
45	9576	2882	9151	5764	8727	8646	8303	1528	7879	4410	15
17 0	9563	2924	9126	5847	8689	8771	8252	1695	7815	4619	73 0
15	9550	2965	9100	5931	8651	8896	8201	1862	7751	4827	45
30	9537	3007	9074	6014	8612	9021	8149	2028	7686	5035	30
45	0.9524	0.3049	1.9048	0.6097	2.8572	0.9146	3.8096	1.2195	4.7620	1.5243	15
18 0	9511	3090	9031	6180	8532	9271	8042	2361	7553	5451	72 0
15	9497	3132	8994	6263	8491	9395	7988	2527	7485	5658	45
30	9483	3173	8966	6346	8450	9519	7933	2692	7416	5865	30
45	9469	3214	8939	6429	8408	9643	7877	2858	7347	6072	15
19 0	9455	3256	8910	6511	8366	9767	7821	3023	7276	6278	71 0
15	9441	3297	8882	6594	8323	9891	7764	3188	7204	6485	45
30	9426	3338	8853	6676	8279	1.0014	7706	3352	7132	6690	30
45	9412	3379	8824	6758	8235	0138	7647	3517	7059	6896	15
20 0	9397	3420	8794	6840	8191	0261	7588	3681	6985	7101	70 0
15	0.9382	0.3461	1.8764	0.6922	2.8146	1.0384	3.7528	1.3845	4.6910	1.7306	45
30	9367	3502	8733	7004	8100	0506	7467	4008	6834	7510	30
45	9351	3543	8703	7086	8054	0629	7405	4172	6757	7715	15
21 0	9336	3584	8672	7167	8007	0751	7343	4335	6679	7918	69 0
15	9320	3624	8640	7249	7960	0873	7280	4498	6600	8122	45
30	9304	3665	8608	7330	7913	0995	7217	4660	6521	8325	30
45	9288	3706	8576	7411	7864	1117	7152	4822	6440	8528	15
22 0	9272	3746	8544	7492	7816	1238	7087	4984	6359	8730	68 0
15	9255	3786	8511	7573	7766	1359	7022	5146	6277	8932	45
30	9239	3827	8478	7654	7716	1481	6955	5307	6194	9134	30
45	0.9222	0.3867	1.8444	0.7734	2.7666	1.1601	3.6888	1.5468	4.6110	1.9336	15
23 0	9205	3907	8110	7815	7615	1722	6820	5629	6025	9537	67 0
15	9188	3947	8376	7895	7564	1842	6752	5790	5940	9737	45
30	9171	3987	8341	7975	7512	1962	6682	5950	5853	9937	30
45	9153	4027	8306	8055	7459	2082	6612	6119	5766	2.0137	15
24 0	9135	4067	8271	8135	7406	2202	6542	6289	5677	0337	66 0
15	9118	4107	8235	8214	7353	2322	6470	6429	5588	0536	45
30	9100	4147	8199	8294	7299	2441	6398	6588	5498	0735	30
45	9081	4187	8163	8373	7214	2560	6326	6746	5407	0933	15
25 0	9063	4226	8126	8452	7189	2679	6252	6905	5315	1131	65 0
15	0.9045	0.4266	1.8089	0.8531	2.7034	1.2797	3.6178	1.7063	4.5223	2.1328	45
30	9026	4305	8052	8610	7078	2915	6103	7220	5129	1526	30
45	9007	4344	8014	8689	7021	3033	6028	7378	5035	1722	15
26 0	8988	4384	7976	8767	6964	3151	5952	7535	4940	1919	64 0
15	8969	4423	7937	8846	6906	3269	5875	7692	4844	2114	45
30	8949	4462	7899	8924	6848	3386	5797	7848	4747	2310	30
45	8930	4501	7860	9002	6789	3503	5719	8004	4649	2505	15
27 0	8910	4540	7820	9080	6730	3620	5640	8160	4550	2700	63 0
15	8890	4579	7780	9157	6671	3736	5561	8315	4451	2894	45
30	8870	4617	7740	9235	6610	3852	5480	8470	4351	3087	30
45	0.8850	0.4656	1.7700	0.9312	2.6550	1.3968	3.5400	1.8625	4.4249	2.3281	15
28 0	8829	4695	7659	9389	6488	4084	5318	8779	4147	3474	62 0
15	8809	4733	7618	9466	6427	4200	5236	8933	4045	3666	45
30	8788	4772	7576	9543	6365	4315	5153	9086	3941	3858	30
45	8767	4810	7535	9620	6302	4430	5069	9240	3836	4049	15
29 0	8746	4848	7492	9696	6239	4544	4985	9392	3731	4240	61 0
15	8725	4886	7450	9772	6175	4659	4900	9545	3625	4431	45
30	8704	4924	7407	9848	6111	4773	4814	9697	3518	4621	30
45	8682	4962	7364	9924	6046	4886	4728	9849	3410	4811	15
30 0	8660	5000	7321	1.0000	5981	5000	4641	2.0000	3301	5000	60 0

Course.	Dist. 6.		Dist. 7.		Dist. 8.		Dist. 9.		Dist. 10.		Course.
	Lat.	Dep.	Lat.	Dep.	Lat.	Dep.	Lat.	Dep.	Lat.	Dep.	
15 15	5.7887	1.5782	6.7535	1.8412	7.7183	2.1042	8.6831	2.3673	9.6479	2.6303	74 45
30	7818	6034	7454	8707	7090	1379	6727	4051	6363	6724	30
45	7747	6286	7372	9001	6996	1715	6621	4430	6246	7144	15
16 0	7676	6538	7288	9295	6901	2051	6514	4807	6126	7564	74 0
15	7603	6790	7203	9588	6804	2386	6404	5185	6005	7983	45
30	7529	7041	7117	9881	6706	2721	6294	5561	5882	8402	30
45	7454	7292	7030	2.0174	6606	3056	6181	5938	5757	8820	15
17 0	7378	7542	6941	0466	6504	3390	6067	6313	5630	9237	73 0
15	7301	7792	6851	0758	6402	3723	5952	6689	5502	9654	45
30	7223	8042	6760	1049	6297	4056	5835	7064	5372	3.0071	30
45	5.7144	1.8292	6.6668	2.1341	7.6192	2.4389	8.5716	2.7438	9.5240	3.0486	15
18 0	7063	8541	6574	1631	6085	4721	5595	7812	5106	0902	72 0
15	6982	8790	6479	1921	5976	5053	5473	8185	4970	1316	45
30	6899	9038	6383	2211	5866	5384	5349	8557	4832	1730	30
45	6816	9286	6285	2501	5754	5715	5224	8980	4693	2144	15
19 0	6731	9534	6186	2790	5641	6045	5097	9301	4552	2557	71 0
15	6645	9781	6086	3078	5527	6375	4968	9672	4409	2969	45
30	6558	2.0028	5985	3366	5411	6705	4838	3.0043	4264	3381	30
45	6471	0275	5882	3654	5294	7033	4706	0413	4118	3792	15
20 0	6382	0521	5778	3941	5175	7362	4572	0782	3969	4202	70 0
15	5.6291	2.0767	6.5673	2.4228	7.5055	2.7689	8.4437	3.1151	9.3819	3.4612	45
30	6200	1012	5567	4515	4934	8017	4300	1519	3667	5021	30
45	6108	1257	5459	4800	4811	8343	4162	1886	3514	5429	15
21 0	6015	1502	5351	5086	4686	8669	4022	2253	3358	5837	69 0
15	5920	1746	5241	5371	4561	8995	3881	2619	3201	6244	45
30	5825	1990	5129	5655	4433	9320	3738	2985	3042	6650	30
45	5729	2233	5017	5939	4305	9645	3593	3350	2881	7050	15
22 0	5631	2476	4903	6222	4175	9969	3447	3715	2718	7461	68 0
15	5532	2719	4788	6505	4043	3.0292	3299	4078	2554	7865	45
30	5433	2961	4672	6788	3910	0615	3149	4442	2388	8268	30
45	5.5332	2.3203	6.4554	2.7070	7.3776	3.0937	8.2998	3.4804	9.2220	3.8671	15
23 0	5230	3414	4435	7351	3640	1258	2845	5166	2050	9073	67 0
15	5127	3685	4315	7632	3503	1580	2691	5527	1879	9474	45
30	5024	3925	4194	7912	3365	1900	2535	5887	1706	9875	30
45	4919	4165	4072	8192	3225	2220	2378	6247	1531	4.0275	15
24 0	4813	4404	3948	8472	3084	2539	2219	6606	1355	0674	66 0
15	4706	4643	3823	8750	2941	2858	2059	6965	1176	1072	45
30	4598	4882	3697	9029	2797	3175	1897	7322	0996	1469	30
45	4489	5120	3570	9306	2651	3493	1733	7679	0814	1866	15
25 0	4378	5357	3442	9583	2505	3809	1568	8036	0631	2262	65 0
15	5.4267	2.5594	6.3312	2.9800	7.2356	3.4125	8.1401	3.8391	9.0446	4.2657	45
30	4155	5831	3181	3.0136	2207	4441	1233	8746	0259	3051	30
45	4042	6067	3049	0411	2056	4756	1063	9100	0070	3445	15
26 0	3928	6302	2916	0686	1904	5070	0891	9453	8.9879	3837	64 0
15	3812	6537	2781	0960	1750	5383	0719	9806	9687	4229	45
30	3696	6772	2645	1234	1595	5696	0644	4.0158	9493	4620	30
45	3579	7006	2509	1507	1438	6008	0368	0509	9298	5010	15
27 0	3460	7239	2370	1779	1281	6319	0191	0859	9101	5399	63 0
15	3341	7472	2231	2051	1121	6630	0012	1209	8902	5787	45
30	3221	7705	2091	2322	0961	6940	7.9831	1557	8701	6175	30
45	5.3099	2.7937	6.1949	3.2593	7.0799	3.7249	7.9649	4.1905	8.8499	4.6561	15
28 0	2977	8168	1806	2863	0636	7558	9465	2252	8295	6947	62 0
15	2853	8399	1662	3132	0471	7866	9280	2599	8089	7332	45
30	2729	8630	1517	3401	0305	8173	9094	2944	7882	7716	30
45	2604	8859	1371	3669	0138	8479	8905	3289	7673	8099	15
29 0	2477	9089	1223	3937	6.9970	8785	8716	3633	7462	8481	61 0
15	2350	9317	1075	4203	9800	9090	8525	3976	7250	8862	45
30	2221	9545	0925	4470	9628	9394	8332	4318	7036	9242	30
45	2092	9773	0774	4735	9456	9697	8138	4659	6820	9622	15
30 0	1962	3.0000	0622	5000	9282	4.0000	7942	5000	6603	5.0000	60 0
	Dep.	Lat.	Dep.	Lat.	Dep.	Lat.	Dep.	Lat.	Dep.	Lat.	
	Dist. 6.		Dist. 7.		Dist. 8.		Dist. 9.		Dist. 10.		

Course.	Dist. 1.		Dist. 2.		Dist. 3.		Dist. 4.		Dist. 5.		Course.
	Lat.	Dep.	Lat.	Dep.	Lat.	Dep.	Lat.	Dep.	Lat.	Dep.	
30 15	0.8638	0.5038	1.7277	1.0075	2.5915	1.5113	3.4553	2.0151	4.3192	2.5189	59 45
30 30	8616	5075	7233	0151	5849	5226	4465	0302	3081	5377	30
30 45	8594	5113	7188	0226	5782	5339	4376	0452	2970	5565	15
31 0	8572	5150	7142	0301	5715	5451	4287	0602	2858	5752	59 0
31 15	8549	5188	7098	0375	5647	5563	4196	0751	2746	5939	45
31 30	8526	5225	7053	0450	5579	5675	4106	0900	2632	6125	30
31 45	8504	5262	7007	0524	5511	5786	4014	1049	2518	6311	15
32 0	8480	5299	6961	0598	5441	5898	3922	1197	2402	6496	58 0
32 15	8457	5336	6915	0672	5372	6008	3829	1345	2286	6681	45
32 30	8434	5373	6868	0746	5302	6119	3736	1492	2170	6865	30
33 45	0.8410	0.5410	1.6821	1.0819	2.5231	1.6229	3.3642	2.1639	4.2052	2.7049	15
33 0	8387	5446	6773	0893	5160	6339	3547	1786	1984	7232	57 0
33 15	8363	5483	6726	0966	5089	6449	3451	1932	1814	7415	45
33 30	8339	5519	6678	1039	5017	6558	3355	2077	1694	7597	30
33 45	8315	5556	6629	1111	4944	6667	3259	2223	1573	7779	15
34 0	8290	5592	6581	1184	4871	6776	3162	2368	1452	7960	56 0
34 15	8266	5628	6532	1256	4798	6884	3064	2512	1329	8140	45
34 30	8241	5664	6483	1328	4724	6992	2965	2656	1206	8320	30
34 45	8216	5700	6433	1400	4649	7100	2866	2800	1082	8500	15
35 0	8192	5736	6383	1472	4575	7207	2766	2943	0958	8679	55 0
35 15	0.8166	0.5771	1.6333	1.1543	2.4499	1.7314	3.2666	2.3086	4.0832	2.8857	45
35 30	8141	5807	6282	1614	4423	7421	2565	3228	0706	9035	30
35 45	8116	5842	6231	1685	4347	7527	2468	3370	0579	9212	15
36 0	8090	5878	6180	1756	4271	7634	2361	3511	0451	9389	54 0
36 15	8064	5913	6129	1826	4193	7739	2258	3652	0322	9565	45
36 30	8039	5948	6077	1896	4116	7845	2154	3793	0193	9741	30
36 45	8013	5982	6025	1966	4038	7950	2050	3933	0063	9916	15
37 0	7986	6018	5973	2036	3959	8054	1945	4073	3.9932	3.0091	53 0
37 15	7960	6053	5920	2106	3880	8159	1840	4212	9800	0365	45
37 30	7934	6088	5867	2175	3801	8263	1734	4350	9668	0438	30
38 45	0.7907	0.6122	1.5814	1.2244	2.3721	1.8367	3.1628	2.4489	3.9534	3.0611	15
38 0	7880	6157	5760	2313	3640	8470	1529	4626	9400	0783	52 0
38 15	7853	6191	5706	2382	3560	8573	1413	4764	9266	0955	45
38 30	7826	6225	5652	2450	3478	8675	1304	4901	9130	1126	30
38 45	7799	6259	5598	2518	3397	8778	1195	5037	8994	1296	15
39 0	7771	6293	5543	2586	3314	8880	1086	5173	8857	1466	51 0
39 15	7744	6327	5488	2654	3232	8981	0976	5308	8720	1635	45
39 30	7716	6361	5432	2722	3149	9082	0865	5443	8581	1804	30
39 45	7688	6394	5377	2789	3065	9183	0754	5578	8442	1972	15
40 0	7660	6428	5321	2856	2981	9284	0642	5712	8302	2139	50 0
40 15	0.7632	0.6461	1.5265	1.2922	2.2897	1.9384	3.0529	2.5845	3.8162	3.2306	45
40 30	7604	6494	5208	2989	2812	9483	0416	5978	8020	2472	30
40 45	7576	6528	5151	3055	2727	9583	0303	6110	7878	2638	15
41 0	7547	6561	5094	3121	2641	9682	0188	6242	7735	2803	49 0
41 15	7518	6593	5037	3187	2555	9780	0074	6374	7592	2967	45
41 30	7490	6626	4979	3252	2469	9879	2.9958	6505	7448	3131	30
41 45	7461	6659	4921	3318	2382	9976	9842	6635	7303	3294	15
42 0	7431	6691	4863	3383	2294	2.0074	9726	6765	7157	3457	48 0
42 15	7402	6724	4804	3447	2207	0171	9609	6895	7011	3618	45
42 30	7373	6756	4746	3512	2118	0268	9491	7024	6864	3780	30
43 45	0.7343	0.6788	1.4686	1.3576	2.2030	2.0364	2.9373	2.7152	3.6716	3.3940	15
43 0	7314	6820	4627	3640	1941	0460	9254	7280	6568	4100	47 0
43 15	7284	6852	4567	3704	1851	0555	9135	7407	6419	4259	45
43 30	7254	6884	4507	3767	1761	0651	9015	7534	6269	4418	30
43 45	7224	6915	4447	3830	1671	0745	8895	7661	6118	4576	15
44 0	7193	6947	4387	3893	1580	0840	8774	7786	5967	4733	46 0
44 15	7163	6978	4326	3956	1489	0934	8652	7912	5815	4890	45
44 30	7133	7009	4265	4018	1398	1027	8530	8036	5663	5045	30
44 45	7102	7040	4204	4080	1306	1120	8407	8161	5509	5201	15
45 0	7071	7071	4142	4142	1213	1213	8284	8284	5355	5355	45 0
	Dep.	Lat.	Dep.	Lat.	Dep.	Lat.	Dep.	Lat.	Dep.	Lat.	Course.
	Dist. 1.		Dist. 2.		Dist. 3.		Dist. 4.		Dist. 5.		

Course.	Dist. 6.		Dist. 7.		Dist. 8.		Dist. 9.		Dist. 10.		Course.
	Lat.	Dep.	Lat.	Dep.	Lat.	Dep.	Lat.	Dep.	Lat.	Dep.	
30 15	5.1830	3.0226	6.0468	3.5264	6.9107	4.0302	7.7745	4.5340	8.6384	5.0377	59 45
30 30	1698	0452	0314	5528	8930	0608	7547	5678	6163	0754	30
45	1564	0678	0158	5791	8753	0903	7347	6016	5941	1120	15
31 0	1430	0902	00 2	6053	8573	1203	7145	6353	5717	1504	59 0
15	1295	1126	5.9844	6314	8393	1502	6942	6690	5491	1877	45
30	1158	1350	9685	6575	8211	1800	6738	7025	5264	2250	30
45	1021	1573	9525	6835	8028	2097	6532	7359	5035	2621	15
32 0	0883	1795	9363	7094	7844	2394	6324	7693	4805	2992	58 0
15	0744	2017	9201	7353	7658	2689	6116	8025	4573	3361	45
30	0603	2238	9037	7611	7471	2984	5905	8357	4339	3730	30
45	5.0462	3.2458	5.8873	3.7868	6.7283	4.3278	7.5694	4.8688	8.4104	5.4097	15
33 0	0320	2678	8707	8125	7094	3571	5480	9018	3867	4464	57 0
15	0177	2898	8540	8381	6903	3863	5266	9346	3629	4829	45
30	0033	3116	8372	8636	6711	4155	5050	9674	3389	5194	30
45	4.9888	3334	8203	8890	6518	4446	4832	5.0001	3147	5557	15
34 0	9742	3552	8033	9144	6323	4735	4613	0327	2904	5919	56 0
15	9595	3768	7861	9396	6127	5024	4393	0652	2659	6280	45
30	9448	3984	7689	9648	5930	5312	4171	0977	2413	6641	30
45	9299	4200	7515	9900	5732	5600	3948	1300	2165	7000	15
35 0	9149	4415	7341	4.0150	5532	5886	3724	1622	1915	7358	55 0
15	4.8998	3.4629	5.7165	4.0400	6.5331	4.6172	7.3498	5.1943	8.1664	5.7715	45
30	8847	4842	6988	0649	5129	6456	3270	2263	1412	8070	30
45	8694	5055	6810	0897	4926	6740	3042	2582	1157	8425	15
36 0	8541	5267	6631	1145	4721	7023	2812	2901	0902	8779	54 0
15	8387	5479	6451	1392	4516	7305	2580	3218	0644	9131	45
30	8231	5689	6270	1638	4309	7586	2347	3534	0386	9482	30
45	8075	5899	6088	1883	4100	7866	2113	3849	0125	9832	15
37 0	7918	6109	5904	2127	3891	8145	1877	4163	7.9864	6.0182	53 0
15	7760	6318	5720	2371	3680	8424	1640	4476	9600	0520	45
30	7601	6526	5535	2613	3468	8701	1402	4789	9335	0876	30
45	4.7441	3.6733	5.5348	4.2855	6.3255	4.8977	7.1162	5.5100	7.9069	6.1222	15
38 0	7281	6940	5161	3096	3041	9253	0921	5410	8801	1566	52 0
15	7119	7146	4972	3337	2825	9528	0679	5718	8532	1909	45
30	6956	7351	4783	3576	2609	9801	0435	6026	8261	2251	30
45	6793	7555	4592	3815	2391	5.0074	0190	6333	7988	2592	15
39 0	6629	7759	4400	4052	2172	0346	6.9943	6639	7715	2932	51 0
15	6464	7962	4207	4289	1951	0616	9695	6943	7489	3271	45
30	6297	8165	4014	4525	1730	0886	9446	7247	7162	3608	30
45	6131	8366	3819	4761	1507	1155	9196	7550	6884	3944	15
40 0	5963	8567	3623	4995	1284	1423	8944	7851	6604	4279	50 0
15	4.5794	3.8767	5.3426	4.5229	6.1059	5.1690	6.8691	5.8151	7.6323	6.4612	45
30	5624	8967	3228	5461	0832	1956	8437	8450	6041	4945	30
45	5454	9166	3030	5693	0605	2221	8181	8748	5756	5276	15
41 0	5283	9364	2830	5924	0377	2485	7924	9045	5471	5606	49 0
15	5110	9561	2629	6154	0147	2748	7666	9341	5184	5935	45
30	4937	9757	2427	6383	5.9916	3010	7406	9636	4896	6262	30
45	4763	9953	2224	6612	9685	3271	7145	9929	4606	6588	15
42 0	4589	4.0148	2020	6839	9452	3530	6883	6.0222	4314	6913	48 0
15	4413	0342	1815	7066	9217	3789	6620	0513	4022	7237	45
30	4237	0535	1609	7291	8982	4047	6355	0803	3728	7559	30
45	4.4059	4.0728	5.1403	4.7516	5.8746	5.4304	6.6089	6.1092	7.3432	6.7880	15
43 0	3881	0920	1195	7740	8508	4560	5822	1380	3135	8200	47 0
15	3702	1111	0986	7963	8270	4815	5553	1666	2837	8518	45
30	3522	1301	0776	8185	8030	5068	5284	1952	2537	8835	30
45	3342	1491	0565	8406	7789	5321	5013	2236	2236	9151	15
44 0	3160	1680	0354	8626	7547	5573	4741	2519	1934	9466	46 0
15	2978	1867	0141	8845	7304	5823	4467	2801	1630	9779	45
30	2795	2055	4.9928	9064	7060	6073	4193	3082	1325	7.0091	30
45	2611	2241	9713	9281	6815	6321	3917	3361	1019	0401	15
45 0	2426	2426	9497	9497	6569	6569	3640	3640	0711	0711	45 0
	Dep.	Lat.	Dep.	Lat.	Dep.	Lat.	Dep.	Lat.	Dep.	Lat.	
	Dist. 6.		Dist. 7.		Dist. 8.		Dist. 9.		Dist. 10.		

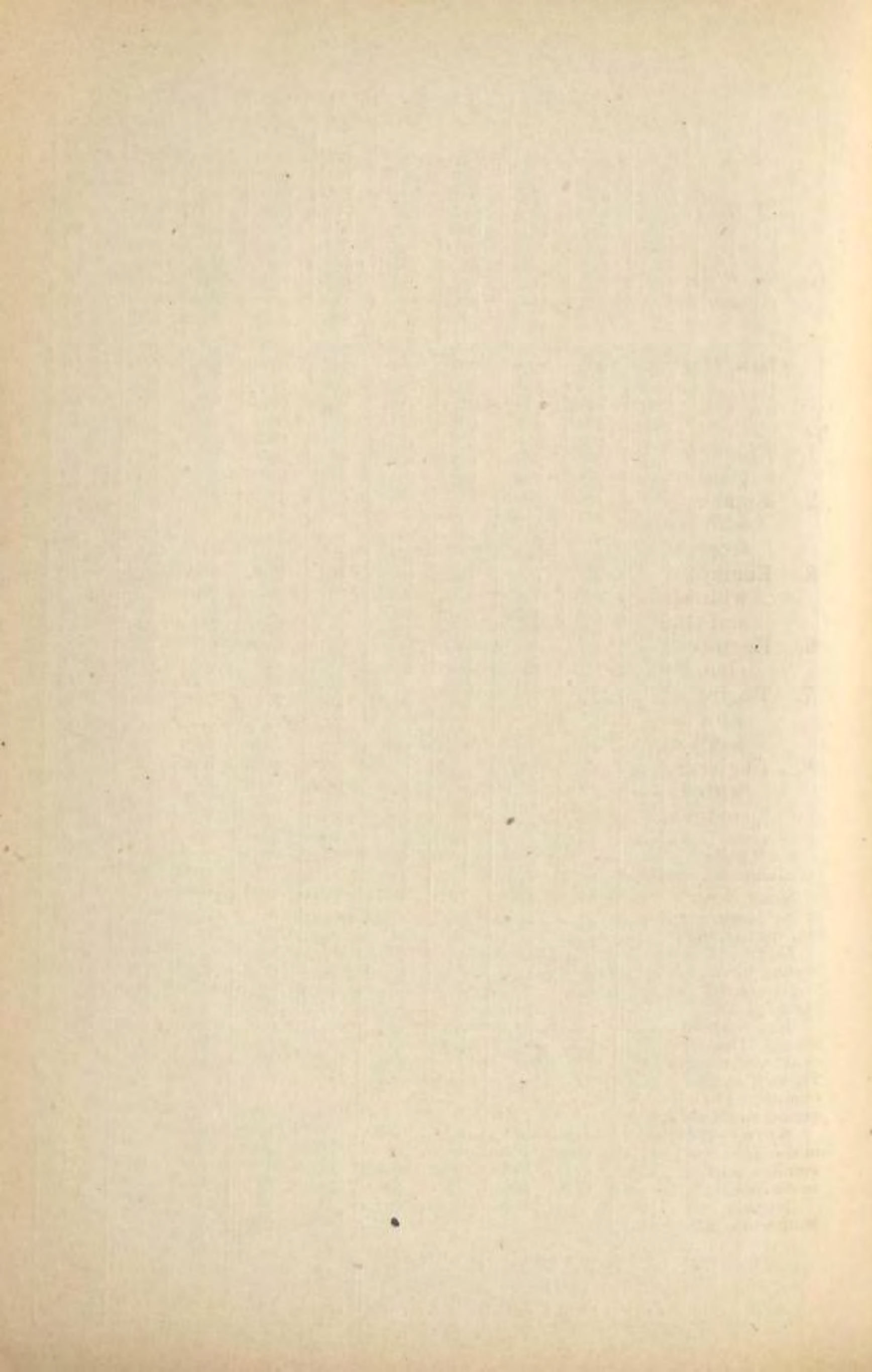

PRICE-LIST.

THIRTY-FIFTH EDITION.

TROY, N. Y., U. S. A., AUGUST, 1901.

ALL PRICES IN THIS WORK ARE IN U. S. CURRENCY. STATE WHAT EDITION OF MANUAL WHEN ORDERING GOODS, AND GIVE CATALOGUE NUMBER.

This Price-List supersedes all previous Editions.

ENGINEERS' TRANSITS.

No.		PRICE.
1.	Engineers' Transit, two verniers to limb, 4-inch needle, plain telescope*.....	\$145.00
2.	Engineers' Transit, two verniers to limb, 4-inch needle, with level on telescope and clamp and tangent to telescope axis.....	163.00
3.	Engineers' Transit, two verniers to limb, 4-inch needle, with 4½-inch vertical circle, level on telescope and clamp and tangent to telescope axis.....	175.00
6.	Engineers' Transit, two verniers to limb, 4½-inch needle, plain telescope.....	150.00
7.	Engineers' Transit, two verniers to limb, 4½-inch needle, with level on telescope and clamp and tangent to telescope axis.....	168.00
8.	Engineers' Transit, two verniers to limb, 4½-inch needle, with 4½-inch vertical circle, level on telescope and clamp and tangent to telescope axis.....	180.00

* A "plain" telescope is one *without* any attachments or extras, such as the clamp and tangent, vertical circle and level.

NOTE.—All our Transits, Nos. 1 to 105 are furnished with shifting center to the leveling-head, and with a tripod and leveling-screws and clamp and tangent to spindle.

NOTE.—The limbs of all our Transits, Nos. 1 to 102, are graduated on sterling silver. The graduation is to half degrees, and is read by vernier to single minutes. A finer graduation is furnished, if desired, at an extra price. See page 256.

The vertical circles and vertical arcs are also graduated on sterling silver. The circle of 3½-inch diameter is graduated to whole degrees and is read by vernier to 5 minutes. The circle of 4½-inch diameter and the arc of 2½-inch radius are graduated to half degrees and are read by vernier to 1 minute. The arc of 3-inch radius is graduated to 20 minutes and is read by vernier to 30 seconds.

NOTE.—If requested when ordering a new Transit, we furnish stadia wires in the telescope, dust guard to the object-glass slide and reflectors to the limb verniers, without extra charge. When desired, we arrange the stadia wires to disappear, or be out of focus, when the plain cross-wires only are in use.

NOTE.—Each Transit is packed in a mahogany case, with lock and leather strap, and has a plummet, reading-glass, adjusting-pins, etc.

ENGINEERS' TRANSITS.—*Concluded.*

No.		PRICE
9.	Engineers' Transit, two verniers to limb, $4\frac{1}{2}$ -inch needle, with vertical arc of 3 inches radius and vernier moved by tangent screw, level on telescope and clamp and tangent to telescope axis.....	\$186.00
10.	Engineers' Transit, two verniers to limb, $4\frac{1}{2}$ -inch needle, with vertical arc of 3 inches radius and vernier moved by tangent screw, level on telescope and gradienter combined with clamp and tangent to telescope axis.....	198.00
12.	Engineers' Transit, two verniers to limb, 5-inch needle, plain telescope, as shown on page 6.....	150.00
13.	Engineers' Transit, two verniers to limb, 5-inch needle, with level on telescope and clamp and tangent to telescope axis.....	168.00
14.	Engineers' Transit, two verniers to limb, 5-inch needle, with $4\frac{1}{2}$ -inch vertical circle, level on telescope and clamp and tangent to telescope axis.....	180.00
15.	Engineers' Transit, two verniers to limb, 5-inch needle, with vertical arc of 3 inches radius and vernier moved by tangent screw, level on telescope and clamp and tangent to telescope axis.....	186.00
16.	Engineers' Transit, two verniers to limb, 5-inch needle, with vertical arc of 3 inches radius and vernier moved by tangent screw, level on telescope and gradienter combined with clamp and tangent, as shown on page 26.....	198.00
17.	Engineers' Transit, two verniers to limb, 5-inch needle, with variation arc, patent Solar Attachment, vertical arc of 3 inches radius and vernier moved by tangent screw, level on telescope, and clamp and tangent to telescope axis, as shown on page 28.....	250.00

NOTE.—A variation arc furnished with any new Engineers' Transit, Nos. 1 to 16, costs extra \$4.00. See No. 130, page 255.

LIGHT MOUNTAIN AND MINING TRANSITS.

25.	Light Mountain Transit, two verniers to limb, 4-inch needle, with variation arc, telescope of finest quality, power 20 diameters, extension tripod shortening to half length. The instrument is packed in a mahogany case, covered with a light sole-leather case, with straps for "packing." With plain telescope.....	\$150.00
26.	Light Mountain Transit, with level on telescope and clamp and tangent to telescope axis.....	168.00
27.	Light Mountain Transit, with $4\frac{1}{2}$ -inch vertical circle, level on telescope and clamp and tangent to telescope axis.....	180.00

LIGHT MOUNTAIN AND MINING TRANSITS.—*Concluded.*

No.		PRICE.
28.	Light Mountain Transit, with vertical arc of $2\frac{1}{2}$ inches radius and vernier moved by tangent screw, level on telescope and clamp and tangent to telescope axis.....	\$186.00
29.	Light Mountain Transit, with vertical arc of $2\frac{1}{2}$ inches radius and vernier moved by tangent screw, level on telescope and gradienter combined with clamp and tangent...	198.00
30.	Light Mountain Transit, with patent Solar Attachment, vertical arc of $2\frac{1}{2}$ inches radius and vernier moved by tangent screw, level on telescope and clamp and tangent to telescope axis, as shown on page 31.....	245.00
31.	Light Mountain Transit, with patent Solar Attachment, Jones' patent latitude arc complete, level on telescope and clamp and tangent to telescope axis, as shown on page 81.....	300.00

SURVEYORS' TRANSITS.

(WITH TWO VERNIERS TO LIMB.)

35.	Surveyors' Transit, two verniers to limb, 4-inch needle, plain telescope.....	\$125.00
36.	Surveyors' Transit, two verniers to limb, 4-inch needle, with level on telescope and clamp and tangent to telescope axis.....	143.00
37.	Surveyors' Transit, two verniers to limb, 4-inch needle, with $4\frac{1}{2}$ -inch vertical circle, level on telescope and clamp and tangent to telescope axis.....	155.00
45.	Surveyors' Transit, two verniers to limb, 5-inch needle, plain telescope.....	130.00
46.	Surveyors' Transit, two verniers to limb, 5-inch needle, with level on telescope and clamp and tangent to telescope axis.....	148.00
47.	Surveyors' Transit, two verniers to limb, 5-inch needle, with $4\frac{1}{2}$ -inch vertical circle, level on telescope and clamp and tangent to telescope axis, as shown on page 34.....	160.00
48.	Surveyors' Transit, two verniers to limb, 5-inch needle, with $4\frac{1}{2}$ -inch vertical circle, level on telescope and gradienter combined with clamp and tangent to telescope axis..	172.00
55.	Surveyors' Transit, same as No. 45, but with $5\frac{1}{2}$ -inch needle.....	130.00
56.	Surveyors' Transit, same as No. 46, but with $5\frac{1}{2}$ -inch needle.....	148.00
57.	Surveyors' Transit, same as No. 47, but with $5\frac{1}{2}$ -inch needle.....	160.00
58.	Surveyors' Transit, same as No. 48, but with $5\frac{1}{2}$ -inch needle.....	172.00

SURVEYORS' TRANSITS.—*Concluded.*

No.		PRICE.
60.	Surveyors' Transit, two verniers to limb, 5-inch needle, with Solar Attachment, vertical arc of 3 inches radius and vernier moved by tangent screw, level on telescope and clamp and tangent to telescope axis, as shown on page 41..	\$226.00

SURVEYORS' TRANSITS.

(WITH ONE VERNIER TO LIMB.)

65.	Surveyors' Transit, one vernier to limb, 4-inch needle, plain telescope.....	\$110.00
66.	Surveyors' Transit, one vernier to limb, 4-inch needle, with level on telescope and clamp and tangent to telescope axis.....	128.00
67.	Surveyors' Transit, one vernier to limb, 4-inch needle, with 4½-inch vertical circle, level on telescope and clamp and tangent to telescope axis.....	140.00
75.	Surveyors' Transit, one vernier to limb, 5-inch needle, plain telescope.....	115.00
76.	Surveyors' Transit, one vernier to limb, 5-inch needle, with level on telescope and clamp and tangent to telescope axis, as shown on page 38.....	133.00
77.	Surveyors' Transit, one vernier to limb, 5-inch needle, with 4½-inch vertical circle, level on telescope and clamp and tangent to telescope axis.....	145.00
78.	Surveyors' Transit, one vernier to limb, 5-inch needle, with 4½-inch vertical circle, level on telescope and gradienter combined with clamp and tangent to telescope axis.....	157.00
85.	Surveyors' Transit, same as No. 75, but with 5½-inch needle.....	115.00
86.	Surveyors' Transit, same as No. 76, but with 5½-inch needle.....	133.00
87.	Surveyors' Transit, same as No. 77, but with 5½-inch needle.....	145.00
88.	Surveyors' Transit, same as No. 78, but with 5½-inch needle.....	157.00
90.	Surveyors' Transit, one vernier to limb, 5-inch needle, with Solar Attachment, vertical arc of 3 inches radius and vernier moved by tangent screw, level on telescope and clamp and tangent to telescope axis, as shown on page 41..	211.00

RECONNOISSANCE TRANSIT.

100.	Reconnaissance Transit, one vernier to limb, 3½-inch needle, with 3½-inch vertical circle, level on telescope and clamp and tangent to telescope axis, leveling-screws and clamp and tangent to spindle, and extension tripod, as shown on page 43.....	\$115.00
------	---	----------

BUILDERS' TRANSIT.

No.		PRICE.
105.	Builders' Transit, with level on telescope, clamp and tangent to telescope axis and to limb and spindle, and with leveling-screws and tripod, as shown on page 45.....	\$80.00

VERNIER TRANSIT-COMPASSSES.

110.	Vernier Transit, 5-inch needle, plain telescope, compass tripod.....	\$ 70.00
111.	Vernier Transit, 5-inch needle, with level on telescope and clamp and tangent to telescope axis.....	88.00
112.	Vernier Transit, 5-inch needle, with 3½-inch vertical circle, level on telescope and clamp and tangent to telescope axis.....	96.00
115.	Vernier Transit, 6-inch needle, plain telescope, compass tripod.....	75.00
116.	Vernier Transit, 6-inch needle, with level on telescope and clamp and tangent to telescope axis.....	93.00
117.	Vernier Transit, 6-inch needle, with 3½-inch vertical circle, level on telescope, and clamp and tangent to telescope axis, as shown on page 47.....	101.00

NOTE.—A leveling-tripod head with parallel plates, leveling-screws and clamp and tangent movement, fitted to Vernier Transits, costs extra \$13.00.

NOTE.—All our Transits, Nos. 35 to 102, and 110 to 117, have a variation arc for setting off the variation of the needle.

ATTACHMENTS AND EXTRAS FOR TRANSITS.

No.		PRICE.	POST.
130.	Variation Arc added to any new Engineers' Transit Nos. 1 to 16, if ordered with the Transit.....	\$ 4.00	
131.	Variation Arc added to Transits when sent for repairs	15.00	
135.	Vertical Circle, 3½ inches diameter, with vernier to 5 minutes, see pages 49 and 50	8.00	\$0.15
136.	Vertical Circle, 4½ inches diameter, with vernier to 1 minute, see page 49.....	12.00	.20
137.	Vertical Circle, 5 inches diameter, with vernier to 1 minute.....	15.00	.20
138.	Vertical Circle, 5 inches diameter, with two opposite double verniers to 1 minute, see page 50.....	35.00	.35
139.	Vertical Arc, 2½ inches radius, with vernier to 1 minute moved by tangent screw, see page 51.....	18.00	.20
140.	Vertical Arc, 3 inches radius, with vernier to 30 seconds moved by tangent screw, see page 51.....	18.00	.20
145.	Level on Telescope with ground vial and scale, see page 52.....	12.00	.25
148.	Clamp and Tangent to telescope axis, see page 52...	6.00	.13

ATTACHMENTS AND EXTRAS FOR TRANSITS.—*Concluded.*

No.		PRICE.	POST.
150.	Gradienter combined with clamp and tangent, see page 55.....	\$18.00	\$0.25
154.	Dust-Guard to object-glass slide, see page 12.....	4.00	
155.	Rack and Pinion movement to eyepiece.....	5.00	
157.	Sights on Telescope with folding joints, see page 54	8.00	
158.	Sights on Standards at right angles with telescope, see page 54.....	8.00	
160.	Detachable Side Telescope and Counterpoise, for vertical sighting, see page 57.....	25.00	.50
161.	Detachable Riding Telescope, for vertical sighting, see page 57.....	25.00	.50
165.	Reflector for illuminating cross-wires, see page 58...	4.00	.10
168.	Diagonal Prism for eyepiece of telescope, see page 58.....	8.00	.10
170.	Plummet-Lamp for Mine-Engineering, see page 59..	10.00	.35
173.	Quick-Leveling Attachment, see page 60.....	6.00	.35
174.	Quick-Leveling Attachment, if ordered with any new Transit Nos. 1 to 105.....	5.00	
176.	Leveling-Head with parallel plates, leveling-screws and clamp and tangent, fitted to Transits Nos. 110 to 117, see page 119.....	13.00	
180.	Attached Magnifiers, with universal joint, to read verniers, each.....	5.00	
185.	Graduation of limb to read to 20 or 30 seconds, extra..	10.00	
186.	Graduation of limb to read to 10 seconds, extra.....	30.00	
187.	Graduation of 4½ or 5-inch vertical circle to read to 20 or 30 seconds, extra.....	5.00	
190.	Patent Solar Attachment with declination arc, hour-circle and polar axis, see page 61.....	60.00	.30
193.	Patent Latitude-Level, for use with Solar Transit, see pages 31 and 79.....	6.00	.15
195.	Jones' patent Latitude Arc, with reversible level, see page 80.....	73.00	
196.	Striding or Adjusting-Level, see page 84	3.00	.15

NOTE.—For Tripods, see pages 172-175 and 261, 262. For Leather Cases, see pages 176 and 263.

SOLAR COMPASS.

	PRICE
210. Burt's Solar Compass, with leveling-screws and clamp and tangent to spindle, and tripod, see page 95.....	\$210.00

NOTE.—For Pocket Solar Compass, see No. 275, and pages 128 and 258.

RAILROAD COMPASSES.

No.		PRICE.
215.	Railroad Compass, two verniers to limb, limb reading to 1 minute, 5-inch needle, brass cover, outkeeper and staff mountings.....	\$70.00
216.	Railroad Compass, two verniers to limb, limb reading to 1 minute, 5½-inch needle, brass cover, outkeeper and staff mountings, see page 100.....	75.00
220.	Railroad Compass, one vernier to limb, limb reading to 1 minute, 5½-inch needle, brass cover, outkeeper and staff mountings, see page 103.....	60.00

These Compasses should always be used on a tripod when practicable. Tripods Nos. 415, 420 and 425 are adapted for use with these Compasses.

VERNIER COMPASSES.

225.	Vernier Compass, 4-inch needle, brass cover, outkeeper and staff mountings.....	\$30.00
226.	Vernier Compass, 5-inch needle, brass cover, outkeeper and staff mountings.....	35.00
227.	Vernier Compass, 6-inch needle, brass cover, outkeeper and staff mountings, see page 106.....	40.00

PLAIN COMPASSES.

230.	Plain Compass, 4-inch needle, brass cover, outkeeper and staff mountings.....	\$25.00
231.	Plain Compass, 5-inch needle, brass cover, outkeeper and staff mountings.....	30.00
232.	Plain Compass, 6-inch needle, brass cover, outkeeper and staff mountings, see page 117.....	35.00

NOTE.—Compasses Nos. 210 to 232 are packed in mahogany case, with lock and leather strap.

ATTACHMENTS AND EXTRAS FOR COMPASSES.

	PRICE.	POST.
240.	Compound Tangent Ball-Spindle, see page 118.....	\$ 7.00 \$0.30
241.	Leveling-Adopter, large size, see page 118.....	7.00 .40
242.	Leveling-Head with parallel plates, leveling-screws and clamp and tangent, fitted to use with tripods Nos. 401, 406, 411, 415, 420 and 425.....	13.00
245.	Compass Tripod Mountings, without the legs.....	4.00 .60

NOTE.—For Tripods, see pages 172-175 and 261 and 262. For leather Cases, see pages 176 and 263.

TELESCOPIC SIGHT. (Patented.)

ATTACHABLE TO COMPASS SIGHT. (*See pages 120-126.*)

No.		PRICE.	Post.
260.	Achromatic Telescope, 9-inch, power about 12 diameters.....	\$15.00	\$0.45
261.	Achromatic Telescope, 9-inch, larger object-glass, power about 20 diameters, see page 120.....	17.00	.45
262.	Achromatic Telescope, 9-inch, same as No. 261, and with stadia wires.....	20.00	.50

We add to any Telescopic Sight the following extras, at prices named:

265.	Vertical Circle, with vernier to 5 minutes.....	5.00	
266.	Level on Telescope, with ground and graduated vial	5.00	
267.	Clamp and Tangent to telescope axis.....	5.00	
268.	Offset-standard, to bring the telescope over the line of zeros.....	5.00	.25

POCKET SOLAR COMPASS.

275.	Pocket Solar Compass, one vernier to limb, limb reading to 1 minute, 3-inch needle, with two levels, folding sights and staff mountings, see page 128...	\$100.00
276.	Pocket Solar Compass, with light tripod.....	105.00
277.	Pocket Solar Compass, with light extension tripod...	110.00
278.	Pocket Solar Compass, with light extension tripod and leveling-plates.....	120.00
280.	Side Telescope and Counterpoise fitted to new Pocket Solar Compass.....	25.00

POCKET RAILROAD COMPASSES.

285.	Pocket Railroad Compass, one vernier to limb, limb 5 inches diameter reading to 1 minute, and with clamp and tangent, 3½-inch needle, folding sights, two levels and staff mountings, see page 131.....	\$40.00
288.	Pocket Railroad Compass, one vernier to limb with clamp and tangent, limb inside the compass-circle and reading to 1 minute, 4½-inch needle, folding sights, two levels and staff mountings, see page 132.....	33.00
290.	Pocket Railroad Compass, 4½-inch needle, clamp and tangent to limb, limb reading to 1 minute, clamp and tangent to main spindle or socket, and fitted with our Telescopic Sight No. 260, with the extras of level, vertical circle to 5 minutes, and clamp and tangent to telescope axis, and with tripod	73.00

POCKET RAILROAD COMPASSES.—*Concluded.*

No.		PRICE.	Post.
291.	Pocket Railroad Compass, same as No. 290, but with Telescope No. 261.....	\$75.00	
292.	Pocket Railroad Compass, same as No. 290, but with Telescope No. 262.....	78.00	
293.	Pocket Railroad Compass, same as No. 292, and with Leveling Adopter, complete as shown on page 133.....	83.00	

POCKET VERNIER COMPASSES.

300.	Pocket Vernier Compass, 3½-inch needle, folding sights, two levels and staff mountings, see page 135	\$16.00	\$0.60
305.	Pocket Vernier Compass, 4½-inch needle, folding sights, two levels and staff mountings, see page 135	18.00	.90
310.	Pocket Vernier Compass, 4½-inch needle, clamp and tangent to main spindle or socket, and fitted with our Telescopic Sight No. 260, with extras of level, vertical circle to 5 minutes and clamp and tangent to telescope axis, and with tripod.....	58.00	
311.	Pocket Vernier Compass, same as No. 310, but with Telescope No. 261.....	60.00	
312.	Pocket Vernier Compass, same as No. 310, but with Telescope No. 262, see page 137.....	63.00	

POCKET PLAIN COMPASSES.

315.	Pocket Plain Compass, 2½-inch needle and folding sights.....	\$ 8.00	\$0.25
316.	Pocket Plain Compass, 2½-inch needle, folding sights and staff mountings, see page 138.....	10.00	.35
317.	Pocket Plain Compass, 3½-inch needle and folding sights.....	10.00	.40
318.	Pocket Plain Compass, 3½-inch needle, folding sights and staff mountings, see page 138.....	12.00	.50
319.	Pocket Plain Compass, 3½-inch needle, folding sights, two levels and staff mountings.....	13.50	.50

EXTRAS FOR POCKET-COMPASSES.

325.	Clamp and Tangent fitted to ball-spindle of Compasses Nos. 285, 288, 300, 305, and 315 to 319..	\$ 5.00	
326.	Rack and Pinion to variation arc of Compasses Nos. 288 to 312.....	4.00	
327.	Leveling-Adopter, small size, see page 138	5.00	\$0.25
328.	Leveling-Head with parallel plates, leveling-screws and clamp and tangent to spindle.....	10.00	

NOTE.—For Tripods, see pages 172-175 and 262. For Leather Cases, see pages 176 and 263.

GEOLOGISTS' AND CLINOMETER COMPASSES.

No.		PRICE.	POST.
335.	Geologists' Compass (of Aluminum), graduated movable sighting circle, graduated base, variation arc, folding sights, two levels, clinometer and staff mountings, see page 139.....	\$24.00	\$0.35
338.	Clinometer Compass (of brass), 3½-inch needle, folding sights, square base, two levels, clinometer and staff mountings, see page 140.....	16.00	.50

A small light tripod for these compasses costs extra \$5.00.

MINERS' COMPASSES OR DIPPING-NEEDLES.

FOR TRACING VEINS OF MAGNETIC IRON ORE.

340.	Miners' Dip-Compass, 3-inch needle with stop, glass on both sides, in wood case, see page 142..	\$12.00	\$0.25
341.	Miners' Dip-Compass, 3-inch needle with stop, glass on both sides, with brass covers.....	12.00	.35
344.	Miners' Dip-Compass, 3-inch Norwegian needle with stop, glass on both sides, with brass covers, see page 142.....	12.00	.35
345.	Miners' Dip-Compass, 4-inch Norwegian needle with stop, glass on both sides, with brass covers..	15.00	.50

DIAL COMPASSES.

348.	Brass Dial Compass, with hour-arc graduated for any latitude as ordered, variation arc, graduated base, one folding sight, two levels and clinometer, see page 144	\$18.00	\$0.40
349.	Dial Compass, same as No. 348, and with staff mountings complete.....	20.50	.50
350.	Aluminum Dial Compass, with hour-arc graduated for any latitude as ordered, graduated base, graduated movable sighting circle, variation arc, one folding sight, one removable sight, two levels, clinometer and staff mountings, see page 146.....	30.00	.45
	Extra Hour-Arcs, graduated for any latitude as ordered, to fit either of these Dial Compasses, each	5.00	.12

A light tripod for the Dial Compasses Nos. 349 and 350 costs extra \$5.00.

LEVELING-INSTRUMENTS.

ENGINEERS' Y-LEVELS.

No.		PRICE.
375.	Y-Level, 22-inch telescope, with leveling-screws, clamp and tangent and tripod.....	\$115.00
376.	Y-Level, 20-inch telescope, with leveling-screws, clamp and tangent and tripod, see page 149.....	110.00
377.	Y-Level, 18-inch telescope, with leveling-screws, clamp and tangent and tripod.....	110.00
378.	Y-Level, 15-inch telescope, with leveling-screws, clamp and tangent and tripod, see page 162.....	90.00

ARCHITECTS' Y-LEVELS.

380.	Architects' Level, 12-inch telescope, with leveling-screws and tripod, see page 163	\$50.00
381.	Architects' Level, 12-inch telescope, with leveling-screws, clamp and tangent and tripod, see page 164.....	65.00

NOTE.— A compass, without sights and with 3-inch needle, can be attached to the telescopes of these leveling-instruments, Nos. 375 to 381, and used to obtain the bearing of lines when desired; its extra cost is \$10.00. Stadia wires are furnished with any of our Y-Levels, free of charge, if requested when the instrument is ordered.

DRAINAGE LEVELS.

	PRICE.
385. Drainage Level, with staff mountings.....	\$15.00
386. Drainage Level, with staff mountings and tripod.....	20.00
387. Drainage Level, with staff mountings, leveling-screws and tripod, see page 168.....	25.00
388. Drainage Level, same as No. 387, and with compass attached, see page 169.....	30.00

NOTE.— All our Levels, Nos. 375 to 388, are packed in mahogany case with lock, and strap or handle. For Level Tripods, see pages 172-175 and 262. For Leather Cases, see pages 176 and 263.

TRANSIT TRIPODS.

	PRICE.
400. Plain Tripod for Transits Nos. 1 to 90, see page 173.....	\$10.00
401. Plain Tripod for Transits Nos. 100 to 117.....	5.00
405. Split-Leg Tripod for Transits Nos. 1 to 90, see page 174...	12.00
406. Split-Leg Tripod for Transits Nos. 100 to 117.....	10.00
410. Extension Tripod for Transits Nos. 1 to 90, see page 175..	15.00
411. Extension Tripod for Transits Nos. 100 to 117.....	12.00

COMPASS TRIPODS.

No.		PRICE.
415.	Plain Tripod for Compasses Nos. 210 to 232, see page 173.	\$5.00
416.	Plain Tripod for Pocket-Compasses Nos. 275 to 319.....	5.00
420.	Split-Leg Tripod for Compasses Nos. 210 to 232.....	10.00
421.	Split-Leg Tripod for Pocket-Compasses Nos. 275 to 319..	8.00
425.	Extension Tripod for Compasses Nos. 210 to 232.....	12.00
426.	Extension Tripod for Pocket-Compasses Nos. 275 to 319..	10.00

LEVEL TRIPODS.

430.	Plain Tripod for Levels Nos. 375 to 378, see page 173.....	\$10.00
431.	Plain Tripod for Levels Nos. 380 to 388.....	5.00
435.	Split-Leg Tripod for Levels Nos. 375 to 378, see page 174.	12.00
436.	Split-Leg Tripod for Levels Nos. 380 to 388.....	10.00.
440.	Extension Tripod for Levels Nos. 375 to 378, see page 175.	15.00
441.	Extension Tripod for Levels Nos. 380 and 381.....	12.00
442.	Extension Tripod for Levels Nos. 385 to 388.....	10.00

BRASS PLUMMETS. Plain.

No.		PRICE.	POST.
450.	Plummet, screw head, steel point, 6 oz.....	\$1.00	\$0.15
452.	Plummet, screw head, steel point, 10 oz.....	1.50	.20
454.	Plummet, screw head, steel point, 16 oz.....	2.00	.25
456.	Plummet, screw head, steel point, 24 oz.....	2.75	.35
458.	Plummet, screw head, steel point, 32 oz.....	3.50	.45
460.	Plummet, screw head, steel point, long neck, 12 oz.....	2.00	.25

BRASS PLUMMETS. Adjustable.

These Plummetts are a concealed reel, R, around which the string is wound by turning the milled head, K, on top. The friction upon the reel will hold the Plummett at any desired point of the line.

465.	Adjustable Plummett, 10 oz.....	\$2.50	\$0.20
469.	Adjustable Plummett, 30 oz.....	5.00	.45

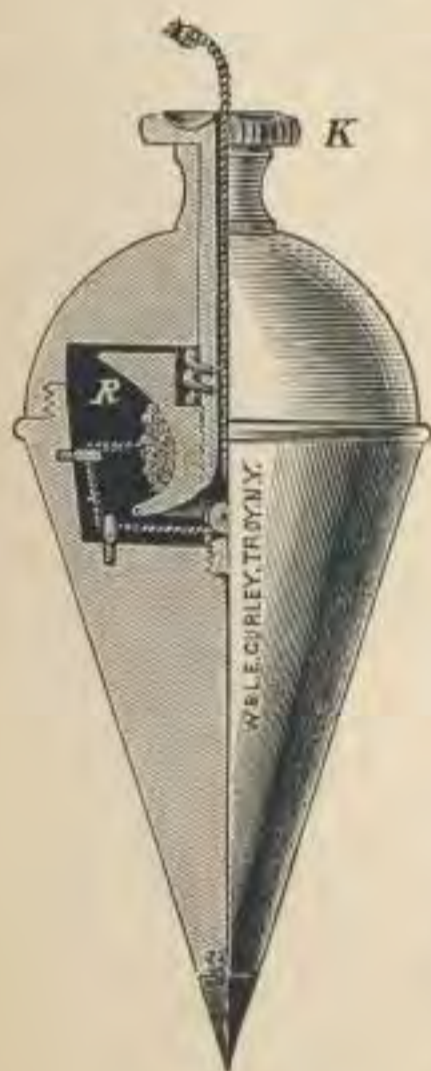

No. 465.

SOLE-LEATHER CASES.

TO FIT OUTSIDE THE WOOD BOX.

No.		PRICE.
475.	Leather Case and Strap, for Engineers' or Surveyors' Transits, price according to size.....	\$8.00 to \$10.00
476.	Leather Case and Strap, for Mountain, Reconnoissance or Builders' Transits.....	8.00
477.	Leather Case and Strap for large Solar Compasses..	10.00
478.	Leather Case and Strap, for Surveyors' Compasses, Nos. 215 to 232, price according to size.....	7.00 to 9.00
479.	Leather Case and Strap, for Engineers' Y-Levels, price according to size.....	8.00 to 10.00
480.	Leather Case and Strap, for Architects' Level.....	7.00
481.	Leather Case and Strap, for Drainage Level.....	4.00

LEATHER CASE AND SHOULDER-STRAP FOR POCKET-COMPASSES, sizes as follows :

	PRICE.	POST.
485. Size for Compasses Nos. 315, 316, 335, 340 to 344, 348 to 350.....	\$2.50	\$0.20
486. Size for Compasses Nos. 300, 317 to 319, 338, 345,	3.00	.30
487. Size for Compasses Nos. 275, 285, 288, 305.....	4.00	.50
488. Size for Compasses Nos. 290 to 293, 310 to 312.....	6.00	

LEATHER POUCH AND SHOULDER-STRAP, fitted to receive Pocket-Compasses without wood box, sizes as follows :



490. Size for Compasses Nos. 315, 316, 335, 340 to 344, 348 to 350.....	\$2.00	\$0.15
491. Size for Compasses Nos. 300, 317 to 319, 338, 345..	2.50	.25
492. Size for Compasses Nos. 288, 305.....	3.00	.35

NOTE.—We are prepared to make to order Leather Cases and Pouches of any style and size that may be desired. See page 110.

LEVELING-RODS. (See pages 177-186.)

No.		PRICE.
500.	Philadelphia Rod, $7\frac{3}{10}$ feet closed, sliding to 13 feet.....	\$14.00
502.	Philadelphia Mining Rod, $3\frac{3}{10}$ feet closed, sliding to 5 feet	12.00
503.	Boston Rod, 6 feet closed, sliding to 11 feet.....	14.00
504.	Troy Rod, $6\frac{1}{2}$ feet closed, sliding to 12 feet.....	10.00
505.	New York Rod, 2 ply, $6\frac{8}{10}$ feet closed, sliding to 12 feet...	14.00
507.	New York Rod, 3 ply, 5 feet closed, sliding to $12\frac{1}{2}$ feet...	18.00
508.	New York Rod, 4 ply, 5 feet closed, sliding to 16 feet.....	20.00
509.	New York Mining Rod, 2 ply, $3\frac{3}{10}$ feet closed, sliding to $5\frac{3}{10}$ feet.....	12.00
510.	Architects' Rod, $5\frac{1}{2}$ feet closed, sliding to 10 feet, in inches and 16ths.....	6.00
511.	Architects' Rod, $5\frac{1}{2}$ feet closed, sliding to 10 feet, in feet and 100ths.....	6.00
512.	Machinists' Rod, $6\frac{1}{2}$ feet long, with swivel hook for shafting	5.00
513.	Telemeter, or Stadia Rod, 6 feet folded, unfolding to 12 feet	12.00
514.	Telemeter, or Stadia Rod, 7 feet folded, unfolding to 14 feet	13.00
515.	Telescopic Rod, 3 ply, 5 feet closed, sliding to 14 feet.....	24.00
516.	Cross-Section Rod, 10 feet long, with level-vial at each end	10.00
518.	Plain Rod, without target, 10 feet long, feet and 100ths...	6.00
519.	Plain Rod, without target, 12 feet long, feet and 100ths...	7.00
520.	Plain Rod, without target, 14 feet long, feet and 100ths...	8.00
521.	Plain Rod, without target, 16 feet long, feet and 100ths...	9.00

NOTE.—Plain Rods, Nos. 518 to 521, if made with a hinge joint at the center, folding once, cost \$2.00 each extra. Any of our Leveling-Rods made with metric graduations without extra charge.

FLEXIBLE OR POCKET LEVELING-RODS.

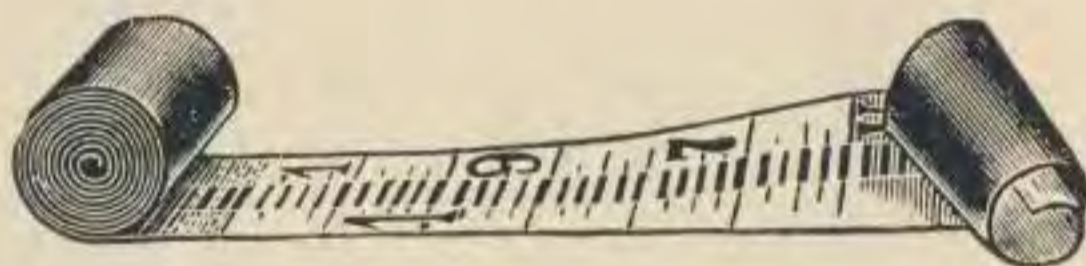

	PRICE.	POST.
525. Pocket Leveling-Rod, 10 feet long, self-reading to feet and 100ths, made of rubber canvas, can be coiled up and carried in pocket; in use it is fastened to a board with thumb tacks.....	\$3.25	\$0.25
526. Pocket Leveling-Rod, same as No. 525, 12 feet long.....	4.00	.30
527. Pocket Leveling-Rod, same as No. 525, 14 feet long.....	4.50	.30
528. Pocket Leveling-Rod, same as No. 525, $3\frac{1}{2}$ meters long, divided to centimeters.....	4.00	.30

COMBINED LEVELING-POLE AND FLAGSTAFF.

	PRICE.
530. Wood Leveling-Pole and Staff, 7 feet long, see page 186...	\$5.00
531. Wood Leveling-Pole and Staff, 9 feet long.....	6.00

WOOD AND IRON FLAGSTAFFS. (See page 187.)

These staffs are divided in feet, which are painted alternately red and white.

No.		PRICE.
534.	Wood Staff, 6 feet long, with metal shoe.....	\$2.00
535.	Wood Staff, 8 feet long, with metal shoe.....	2.25
536.	Wood Staff, 10 feet long, with metal shoe.....	2.50
539.	Aligning or Ranging-Pole, 6 feet long, hung in gimbals...	4.00

NOTE.—This pole consists of an iron tube, $\frac{1}{16}$ of an inch diameter, 6 feet long, and being hung in gimbals always assumes a vertical position.

541.	Iron Tubular Ranging-Pole, 6 feet long, $\frac{1}{16}$ inch diameter	2.75
543.	Iron Tubular Ranging-Pole, 8 feet long, $\frac{1}{16}$ inch diameter	3.00

NOTE.—Any of the above staffs with metric graduations (five to a meter) at same price.

	PRICE.	POST.
545. Rod-Level, for plumbing a Rod or Staff, see page 188	\$3.00	\$0.15

PLANE-TABLE OUTFITS.

No.		PRICE.
549.	Plane-Table, with board 30x24 inches, mounted on large tripod with leveling-socket and clamp, and with plumb- ing-arm, plummet and clamps for paper.....	\$45.00
	Set of three leveling-screws.....	10.00
	Clamp and tangent, for movement in azimuth.....	10.00
	Combined Compass with levels and square base.....	15.00
	Alidade with telescope 11 inches long, with stadia, $4\frac{1}{2}$ - inch vertical circle to 1 minute, level on telescope and clamp and tangent, on column, power of telescope 24 diameters, see page 197, No. 583.....	90.00
	Total, as shown on page 192.....	<u>\$170.00</u>
550.	Plane-Table, with board 30x24 inches, mounted on large tripod with leveling-socket and clamp, and with plumb- ing-arm, plummet and clamps for paper.....	\$45.00
	Combined Compass with levels and square base.....	15.00
	Alidade with telescope 11 inches long, with stadia, $4\frac{1}{2}$ -inch vertical circle to 1 minute, level on telescope and clamp and tangent, on column, power of telescope 24 diameters, see page 197, No. 583.....	90.00
	Total.....	<u>\$150.00</u>
553.	Plane-Table, with board, tripod, etc., like No. 550.....	\$45.00
	Combined Compass with levels and square base.....	15.00
	Alidade with telescope 9 inches long, power 20 diameters, with stadia, vertical circle to 1 minute, level on tele- scope and clamp and tangent, on column, see page 197, No. 582.....	70.00
	Total, as shown on page 189.....	<u>\$130.00</u>
556.	Plane-Table, with board, tripod, etc., like No. 550.....	\$45.00
	Combined Compass with levels and square base.....	15.00
	Alidade with telescopic sight No. 262, with stadia, vertical circle to 5 minutes, level and clamp and tangent, see page 196, No. 581.....	50.00
	Total.....	<u>\$110.00</u>
559.	Plane-Table, with board, tripod, etc., like No. 550.....	\$45.00
	Combined Compass with levels and square base.....	15.00
	Alidade with compass-sights, see page 196, No. 580.....	15.00
	Total.....	<u>\$75.00</u>
560.	Plane-Table, with board, tripod, etc., as described in No. 550, and omitting Compass and Alidade.....	\$45.00
563.	Set of three leveling-screws for Plane-Tables Nos. 550-560, extra.....	10.00
564.	Clamp and tangent, for movement in azimuth, for Plane- Tables Nos. 550-560, extra.....	10.00

JOHNSON'S IMPROVED PLANE-TABLE AND EXTRAS.

(Prices for separate parts. See engraving, page 195.)

No.		PRICE.
570.	Johnson's Plane-Table Movement and tripod.....	\$45.00
573.	Drawing-Board, 31x24 inches, with brass screw-plate fitted, and with eight clamp-screws and sockets for paper.....	5.00
574.	Plumbing-arm and plummet.....	4.00
575.	Combined Compass with levels and square base.....	15.00

JOHNSON'S PLANE-TABLE OUTFITS.

576.	Johnson's Plane-Table Movement and tripod, with drawing-board, 31x24 inches, with brass screw-plate fitted, and with eight clamp-screws and sockets for paper.....	\$50.00
	Plumbing-arm and plummet.....	4.00
	Combined Compass with levels and square base.....	15.00
	Alidade with telescope 11 inches long, with stadia $4\frac{1}{2}$ -inch vertical circle to 1 minute, level on telescope and clamp and tangent, on column, power of telescope 24 diameters, see page 197, No. 583.....	90.00
	Total, as shown on page 195.....	<u>\$159.00</u>
577.	Plane-Table, with tripod, board, etc., like No. 576.....	\$50.00
	Plumbing-arm and plummet.....	4.00
	Combined Compass with levels and square base.....	15.00
	Alidade with telescope 9 inches long, power 20 diameters, with stadia, vertical circle to 1 minute, level on telescope and clamp and tangent, on column, No. 582...	70.00
	Total.....	<u>\$139.00</u>
578.	Plane-Table, with tripod, board, etc., like No. 576.....	\$50.00
	Plumbing-arm and plummet.....	4.00
	Combined Compass with levels and square base.....	15.00
	Alidade with telescopic sight No. 262, with stadia, vertical circle to 5 minutes, level and clamp and tangent, see page 196, No. 581.....	50.00
	Total	<u>\$119.00</u>
579.	Plane-Table, with tripod, board, etc., like No. 576.....	\$50.00
	Plumbing-arm and plummet.....	4.00
	Combined Compass with levels and square base.....	15.00
	Alidade with compass-sights, see page 196, No. 580.....	15.00
	Total.....	<u>\$84.00</u>

ALIDADES.

No.		PRICE.
580.	Alidade with compass-sights, see page 196.....	\$15.00
581.	Alidade with telescopic sight No. 262, with stadia, vertical circle to 5 minutes, level and clamp and tangent, * see page 196.....	50.00
582.	Alidade with telescope 9 inches long, power 20 diameters, with stadia, vertical circle to 1 minute, level on telescope and clamp and tangent, on column as in engraving, see page 189.....	70.00
583.	Alidade with telescope 11 inches long, with stadia, 4½-inch vertical circle to 1 minute, level on telescope and clamp and tangent, on column, power of telescope 24 diameters, see page 197.....	90.00
584.	Alidade with telescope 11 inches long, stadia, vertical arc to 1 minute, detachable striding level, axis tangent, diagonal prism for eyepiece. The telescope has a power of 24 diameters, and is made erecting or inverting, as ordered, and is mounted on column.....	118.00

NOTE.—The Alidades as above described, can be used with any of our Plane-Tables Nos. 549-579, and will be sold separately at the prices named.

TRAVERSE PLANE-TABLE — U. S. G. S. PATTERN.

586.	Traverse-Table Board, 15x15 inches, with Box-Compass let into one edge, Ruler-Alidade with graduated edge and folding sights, and with tripod, complete as shown on page 198.....	\$25.00
------	---	---------

If the tripod has extension legs, add extra \$5.00.

When desired we furnish separate parts of this Plane-Table at the following prices :

587.	Drawing-Board with brass screw-plate, and with tripod head and plain legs.....	\$9.00
588.	Box-Compass, rectangular metal case, 3-inch needle.....	8.00
589.	Ruler-Alidade with graduated edge and folding sights.....	10.00

CURRENT-METERS.

W. G. PRICE'S PATENT.

For measuring the velocity of the current of rivers and harbors,
at any depth.

No.		PRICE.
600.	Current-Meter for Harbors and Rivers, see page 200.....	\$100.00
604.	Brass Tubing, graduated to feet and tenths, and jointed in 4-ft. lengths, per length.....	5.00
606.	Lead Weight, 60 lbs., with connections, see page 200.....	15.00
609.	Electric Register, see pages 200 and 204.....	50.00
610.	Dry Cell Battery of three cells, in box with lock and strap,	4.00
612.	Wet Cell Battery of three cells, in box with lock and strap,	7.00
614.	Insulated Copper Wire for battery, per foot.....	.03
616.	Acoustic Current-Meter for small streams, see page 207...	50.00
617.	Electric Current-Meter for small streams, complete with electric sounder, cable and weight.....	70.00
619.	Time-Recorder, open face, nickel case, stem-winder, with fly-back attachment for starting and stopping. Register- ing minutes, seconds and fifths of seconds	6.00
620.	Boyden's Hook-Gauge, see page 210.....	25.00

HAND-LEVELS.

		PRICE.	POST.
625.	Monocular Hand-Level, in case, see page 212.....	\$12.00	\$0.20
627.	Binocular Hand-Level, in case, see page 212.....	15.00	.35
630.	Locke's Hand-Level, nickel-plated, in case, see page 214.....	8.00	.20
634.	Abney Level, an improved "Locke's Hand-Level," giving angles of elevation; also graduated for slopes, as 1 to 1, 2 to 1, etc.; in case, see page 215.....	13.50	.25
636.	Abney Level, same as No. 634, with compass and staff socket attached.....	18.00	.30

NOTE.—Nos. 625 to 634 are our own make; No. 636 is of foreign make.

CHAINS. (*See pages 223-226.*)

No.		PRICE.	POST.
650.	33 feet, 50 links, oval rings, No. 10 refined iron wire	\$2.25	\$0.65
651.	33 feet, 50 links, oval rings, No. 8 refined iron wire	2.50	.85
652.	66 feet, 100 links, oval rings, No. 10 refined iron wire	3.50	1.15
653.	66 feet, 100 links, oval rings, No. 8 refined iron wire	4.00	1.75
656.	33 feet, 50 links, oval rings, No. 10 best steel wire	4.00	.65
658.	50 feet, 50 links, oval rings, No. 10 best steel wire	4.75	.80
659.	50 feet, 50 links, oval rings, No. 8 best steel wire	5.50	.90
660.	66 feet, 100 links, oval rings, No. 10 best steel wire	7.00	1.15
662.	100 feet, 100 links, oval rings, No. 10 best steel wire	8.50	1.50
663.	100 feet, 100 links, oval rings, No. 8 best steel wire	10.00	1.80

BRAZED STEEL CHAINS.

670.	33 feet, 50 links, No. 12 tempered steel wire, brazed links and rings.....	\$ 5.00	\$0.45
671.	50 feet, 50 links, No. 12 tempered steel wire, brazed links and rings.....	6.00	.55
672.	66 feet, 100 links, No. 12 tempered steel wire, brazed links and rings.....	9.00	.70
673.	100 feet, 100 links, No. 12 tempered steel wire, brazed links and rings.....	10.00	1.00

Our brazed steel chains displace the ordinary chains wherever they are tried, on account of superior lightness and strength. They are practically the only chains now used in railroad construction.

Chains of two and four poles with 40 and 80 links, same price as chains of 50 and 100 links.

Steel snaps to make full chains into "half chains," without extra charge, if ordered with the chain.

GRUMMAN PATENT STEEL CHAINS.

680.	33 feet, 50 links, No. 15 tempered steel wire, weight 1 lb.....	\$ 5.00	\$0.28
681.	50 feet, 100 links, No. 15 tempered steel wire, weight $1\frac{1}{4}$ lbs.....	6.00	.30
682.	66 feet, 100 links, No. 15 tempered steel wire, weight $1\frac{1}{2}$ lbs.....	9.00	.35
683.	100 feet, 200 links, No. 15 tempered steel wire, weight $2\frac{1}{4}$ lbs.....	11.00	.50
685.	50 feet, 100 links, No. 18 tempered steel wire, with spring-balance, level and thermometer, for very accurate measurements, weight $14\frac{1}{2}$ oz.....	15.00	.25
688.	Spring-balance with handle and steel snap, to use with chains Nos. 680 to 683.....	2.50	.15

VARA CHAINS.

No.		PRICE.	POST.
690.	10 varas, 50 links, oval rings, No. 10 refined iron wire.....	\$ 2.25	\$0.55
691.	10 varas, 50 links, oval rings, No. 8 refined iron wire.....	2.50	.75
694.	20 varas, 100 links, oval rings, No. 10 refined iron wire.....	3.50	1.00
695.	20 varas, 100 links, oval rings, No. 8 refined iron wire.....	4.00	1.65
700.	10 varas, 50 links, oval rings, No. 10 best steel wire.....	4.00	.55
704.	20 varas, 100 links, oval rings, No. 10 best steel wire.....	7.00	1.00
708.	10 varas, 50 links, oval rings, No. 12 tempered steel wire, brazed links and rings.....	5.00	.35
710.	20 varas, 100 links, oval rings, No. 12 tempered steel wire, brazed links and rings.....	9.00	.65

METER CHAINS.

715.	10 meters, 50 links, oval rings, No. 10 refined iron wire.....	\$ 2.25	\$0.65
716.	10 meters, 50 links, oval rings, No. 8 refined iron wire.....	2.50	.85
719.	20 meters, 100 links, oval rings, No. 10 refined iron wire.....	3.50	1.15
720.	20 meters, 100 links, oval rings, No. 8 refined iron wire.....	4.00	1.75
723.	10 meters, 50 links, oval rings, No. 10 best steel wire.....	4.00	.65
727.	20 meters, 100 links, oval rings, No. 10 best steel wire.....	7.00	1.15
730.	10 meters, 50 links, oval rings, No. 12 tempered steel wire, brazed links and rings.....	5.00	.45
732.	20 meters, 100 links, oval rings, No. 12 tempered steel wire, brazed links and rings.....	9.00	.70

MARKING-PINS AND TIMBER-SCRIBE.

740.	Set of 11 Pins, No. 4 iron wire, 14 inches long.....	\$1.25	\$0.50
742.	Set of 11 Pins, No. 6 steel wire, 14 inches long.....	1.50	.40
744.	Set of 11 Pins, No. 6 steel wire weighted, 14 inches long.....	2.50	1.25
746.	Set of 11 Pins, No. 10 steel wire, 9 inches long, in leather pouch.....	2.00	.25
748.	Set of 11 Pins, No. 4 brass wire, 14 inches long.....	2.50	.50
750.	Timber-Scribe, for marking trees, posts or boards....	1.25	.15

STEEL RIBBON CHAIN-TAPES.

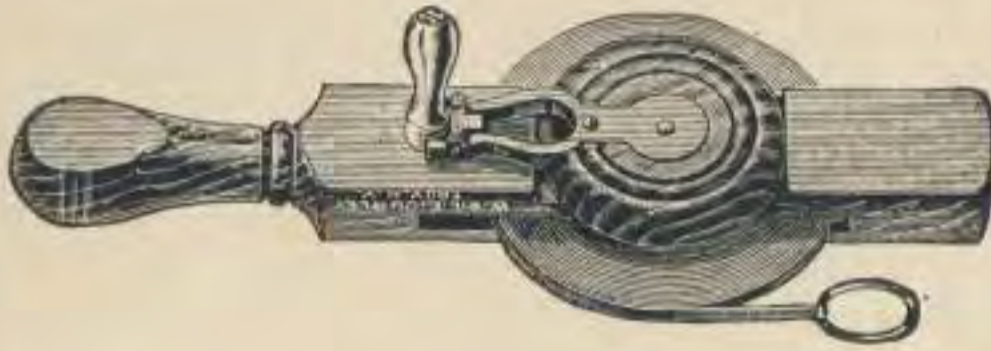
 $\frac{1}{4}$ INCH WIDE, AND WITH HANDLES AND REEL.

No.		PRICE.	POST.
760.	Steel Ribbon, 33 feet, graduated each link.....	\$3.50	\$0.25
761.	Steel Ribbon, 50 feet, graduated each foot.....	4.00	.30
762.	Steel Ribbon, 66 feet, graduated each link.....	4.50	.35
763.	Steel Ribbon, 100 feet, graduated each foot.....	5.00	.40
765.	Steel Ribbon, 200 feet, graduated each foot up to 100 feet, and the last 100 feet graduated each 10 feet.....	7.50	.70
767.	Steel Ribbon, 300 feet, graduated each foot up to 100 feet, and the last 200 feet graduated each 10 feet.....	10.00	

The 50, 100, 200 and 300 feet Chain-tapes also have the first and last foot in 10ths.

STEEL RIBBON BRIDGE-TAPES.

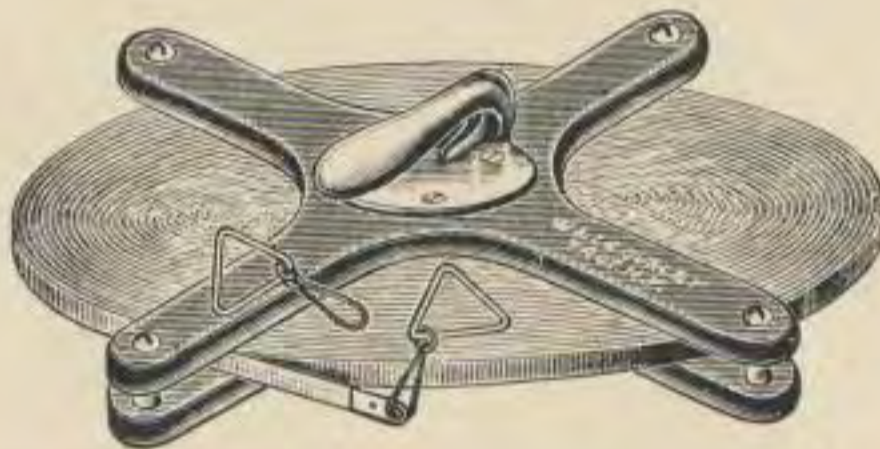
 $\frac{1}{4}$ INCH WIDE, WITH HANDLES AND EXTRA FINE REELS.

No.		PRICE.
770.	Steel Ribbon, 300 feet, graduated each 5 feet.....	\$13.00
771.	Steel Ribbon, 400 feet, graduated each 5 feet.....	15.00
772.	Steel Ribbon, 500 feet, graduated each 5 feet.....	17.00

Our Bridge-tapes are mounted on substantial wooden reels with aluminum and brass mountings and swivel handle.

These tapes have the first and last 5 feet graduated each foot.

METALLIC TAPES.

Made of linen thread, interwoven with fine brass wire. They are $\frac{5}{8}$ -inch wide, and in leather cases. The graduations are in 10ths or 12ths of a foot, as desired, on one side and in links on the reverse side.

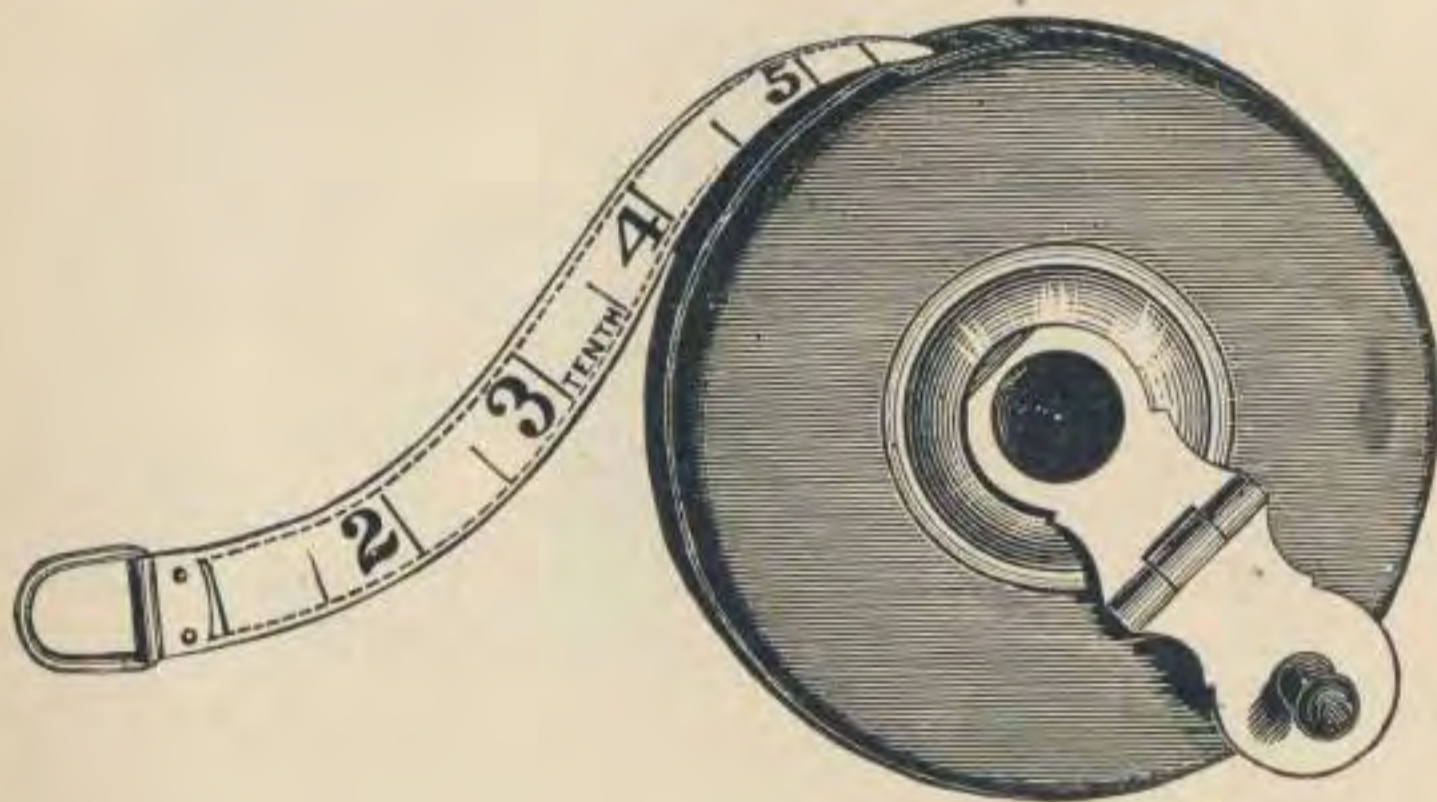

No.		PRICE.	POST.
780.	Metallic Tape, 33 feet, in 10ths or 12ths, and links..	\$2.10	\$0.18
782.	Metallic Tape, 50 feet, in 10ths or 12ths, and links..	2.60	.20
783.	Metallic Tape, 66 feet, in 10ths or 12ths, and links..	3.00	.25
786.	Metallic Tape, 100 feet, in 10ths or 12ths, and links	4.20	.30

NOTE.—We can furnish metallic tapes with metric or vara measure on reverse side, instead of links, at an extra cost of one cent per foot.

METALLIC TAPES WITHOUT CASES.

These tapes can be put into the leather cases when the original tape line is worn out.

790.	Metallic Tape, 33 feet, in 10ths or 12ths, and links, without case.....	\$1.10	\$0.12
791.	Metallic Tape, 50 feet, in 10ths or 12ths, and links, without case.....	1.50	.15
792.	Metallic Tape, 66 feet, in 10ths or 12ths, and links, without case.....	1.80	.18
794.	Metallic Tape, 100 feet, in 10ths or 12ths, and links, without case.....	2.90	.20

STANDARD STEEL TAPES.

ALL STEEL, $\frac{3}{8}$ -INCH WIDE, IN LEATHER CASES; THE MOST ACCURATE,
DURABLE AND PORTABLE MEASURES.

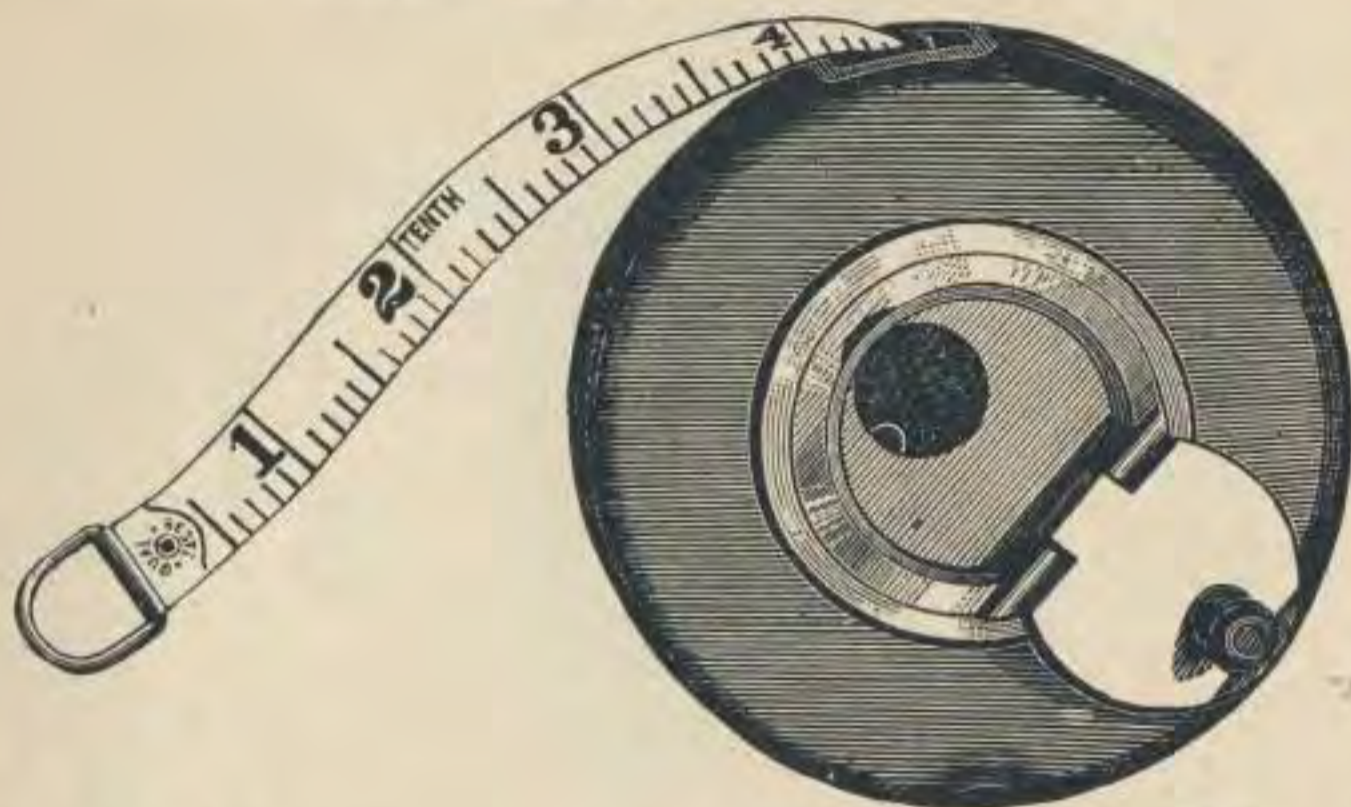

No.						PRICE.	POST.
800.	Steel Tape, 25 feet, in 10ths or 12ths, and links.....					\$ 3.75	\$0.15
801.	“ “ 33 feet, “ “ “ “					4.30	.18
802.	“ “ 50 feet, “ “ “ “					6.00	.20
803.	“ “ 66 feet, “ “ “ “					7.60	.23
804.	“ “ 75 feet, “ “ “ “					8.60	.25
805.	“ “ 100 feet, “ “ “ “					10.60	.30

THE “STAR” STEEL TAPE.

$\frac{3}{8}$ -INCH WIDE, IN NICKELED BRASS CASES.

810.	“Star” Steel Tape, 50 feet, in 10ths or 12ths, and links.....					\$4.50	\$0.20
811.	“Star” Steel Tape, 66 feet, in 10ths or 12ths, and links.....					5.50	.25
812.	“Star” Steel Tape, 75 feet, in 10ths or 12ths, and links					6.00	.30
813.	“Star” Steel Tape, 100 feet, in 10ths or 12ths, and links.....					8.00	.35

PAINE’S PATENT STEEL TAPES.

$\frac{1}{4}$ -INCH WIDE, IN LEATHER CASES, FOLDING HANDLES.

820.	Steel Tape, 33 feet, in 10ths or 12ths, and links.....					\$4.40	\$0.18
821.	“ “ 50 feet, “ “ “ “					6.40	.23
822.	“ “ 66 feet, “ “ “ “					8.00	.28
823.	“ “ 75 feet, “ “ “ “					9.60	.30
824.	“ “ 100 feet, “ “ “ “					12.00	.35

PAINE'S PATENT STEEL TAPES.

$\frac{1}{4}$ -INCH WIDE, IN METAL CASES, FOLDING HANDLES.

No.							PRICE.	POST.
830.	Steel Tape,	25 feet,	in 10ths or 12ths,	and links.....			\$2.80	\$0.15
831.	"	"	33 "	"	"	"	3.60	.18
832.	"	"	50 "	"	"	"	4.80	.23
833.	"	"	66 "	"	"	"	6.40	.28
834.	"	"	75 "	"	"	"	8.00	.30
835.	"	"	100 "	"	"	"	9.60	.35

NOTE.—Paine's Tapes (50 to 100 feet) are detachable from their cases, and furnished with an extra handle (No. 841), and can be used as a chain-tape.

Tapes Nos. 800 to 835 with metric or vara measure on reverse side, instead of links, at an extra cost of two and one-half cents per foot.

EXTRAS FOR PAINE'S PATENT STEEL TAPES.

840.	Compensating handles, detachable, with graduated scale, per pair.....	\$2.40	\$0.12
841.	Plain Finger-ring Handles, detachable, each.....	.40	.02
843.	Pocket Thermometers, each.....	.85	.15
844.	Spring-Balance, with handle and snap.....	2.50	.15
845.	Spring-Balance and Level, with handle and snap ...	4.00	.15

EXCELSIOR STEEL TAPES.

$\frac{1}{2}$ -INCH WIDE, ON BRASS FRAME WITH HANDLE.

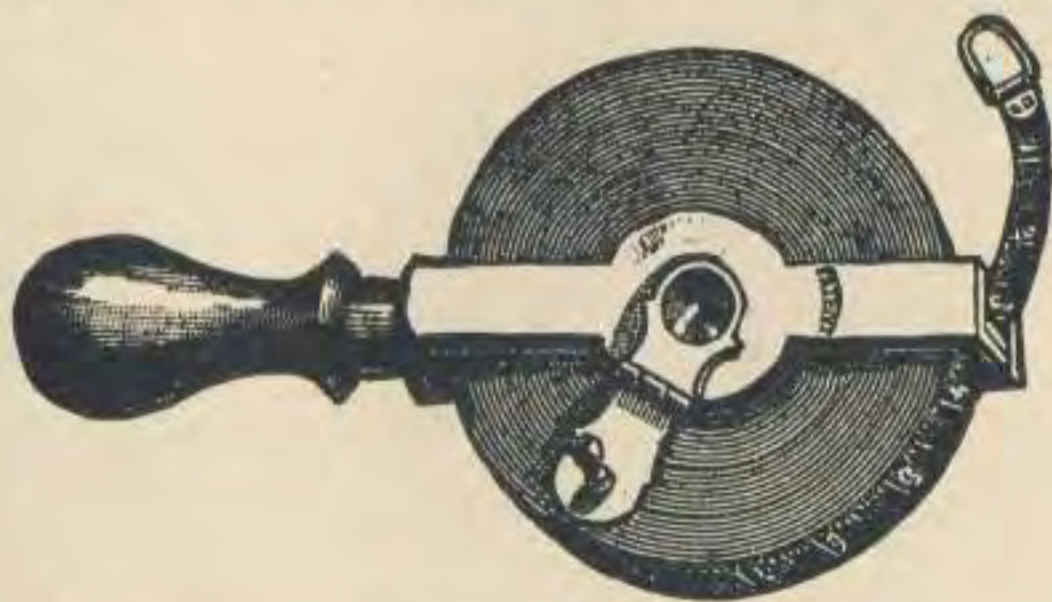

850.	Steel Tape, 33 feet, in 10ths or 12ths, and links.....	\$ 5.00	\$0.20
851.	" " 50 " " " " " " " " " " " "	6.40	.25
852.	" " 66 " " " " " " " " " " " "	8.00	.30
853.	" " 100 " " " " " " " " " " " "	11.50	.40

EXCELSIOR STEEL TAPES.—*Concluded.*

No.		PRICE.	POST.
855.	Steel Tape, 50 feet, in 10ths or 12ths, and meters,	\$ 7.65	\$0.25
858.	“ “ 100 “ “ “ “	14.00	.40

NOTE.—Tapes Nos. 800 to 858 are graduated to feet, 10ths and 100ths of a foot, or to feet, inches and 8ths of inches, as desired, on one side and in links on the reverse side.

METRIC AND VARA TAPES.

We can furnish any of our tapes, Nos. 780–835, with metric or vara measure only, at prices for regular style of tapes of similar lengths in feet. If with metric or vara measure on reverse side, instead of links, the extra cost will be as stated on pages 273 and 275.

NICKEL-PLATED TAPES.

When desired, we will nickel-plate our steel tapes, Nos. 800–835 and 850–858, to protect from rust, at the following prices:

	25	33	50	66	75	100	feet
each \$.90	.90	1.35	1.55	1.55	1.75	

POCKET STEEL TAPES.

IN GERMAN SILVER CASES, WITH SPRING AND STOP.

860.	Pocket Steel Tape, 3 feet, in 10ths or 12ths.....	\$1.00	\$0.11
863.	“ “ “ 6 “ “ “	1.40	.12
866.	“ “ “ 12 “ “ “	2.50	.15
870.	Pocket Steel Tape, 6 feet, in 10ths one side and 12ths reverse side.....	1.60	.12
873.	Pocket Steel Tape, 12 feet, in 10ths one side and 12ths reverse side.....	2.80	.15
875.	Pocket Steel Tape, 3 feet, in 10ths or 12ths, and meter.....	1.10	.11
877.	Pocket Steel Tape, 6 feet, in 10ths or 12ths, and meter.....	1.60	.12
879.	Pocket Steel Tape, 12 feet, in 10ths or 12ths, and meter.....	2.80	.15

SUPPLEMENT

TO

Thirty-Fifth Edition of Manual.

AUGUST, 1901.

. The prices in this Catalogue may vary from time to time, on account of fluctuations in Market Rates.

This Price-List supersedes all previous editions, and has been carefully revised and enlarged.

 When ordering goods always state what edition of Manual, and number in Catalogue.

DRAWING-INSTRUMENTS.

TO GUIDE the Surveyor and Engineer in the selection of Drawing-Instruments, we here add a detailed description, with illustrations and prices of the separate pieces and cases of the different kinds in general use.

Those we shall first mention are of Swiss manufacture, of the finest quality and finish, and are made of the best German silver and English steel.

We show first the regular patterns and then those with the celebrated pivot-joint.

The Alteneder instruments are the best of American manufacture, and are equally good with those of Swiss make.

The fine German silver instruments, of German make, are the best of their kind.

The instruments before mentioned are intended for Engineers, Architects, Draftsmen, Machinists and Students in Technical Schools.

The cheaper German silver, brass and nickel-plated instruments are for Common School use and elementary practice.

Parties wanting special cases made up, can select the pieces, and we will make cases to suit, at an additional cost of from \$2 to \$10, according to the size and quality of the cases, which are made of morocco, rosewood, or mahogany.

For prices of regular size cases, see page 288.

For the convenience of our customers, we will furnish any articles not on our list, but described in the catalogue of any American manufacturer or dealer in mathematical instruments, at catalogue prices.

SPECIAL NOTICE.

MANY of our smaller instruments, such as drawing-instruments, pocket-compasses, chains, tapes, small packages of paper and parts of large instruments, can be sent by mail securely packed, and at much lower rates than are charged by Express Companies. Packages not exceeding four pounds in weight can be sent in this way within the United States, Canada and Mexico at a cost of one cent per ounce.

In all cases where goods are to be sent by mail, the cash for postage as well as for the goods must accompany the order.

The postage required is mentioned in the second column of the Price-List, and for articles worth more than one dollar the amount named for postage includes the cost of registry.

All articles can be registered at an extra cost of eight cents for each package besides regular postage. Packages for registry should not exceed four feet in length.

We are not responsible for goods lost or injured when sent by mail.

SUPERIOR SWISS DRAWING-INSTRUMENTS.
OF GERMAN SILVER, EXTRA FINE FINISH.

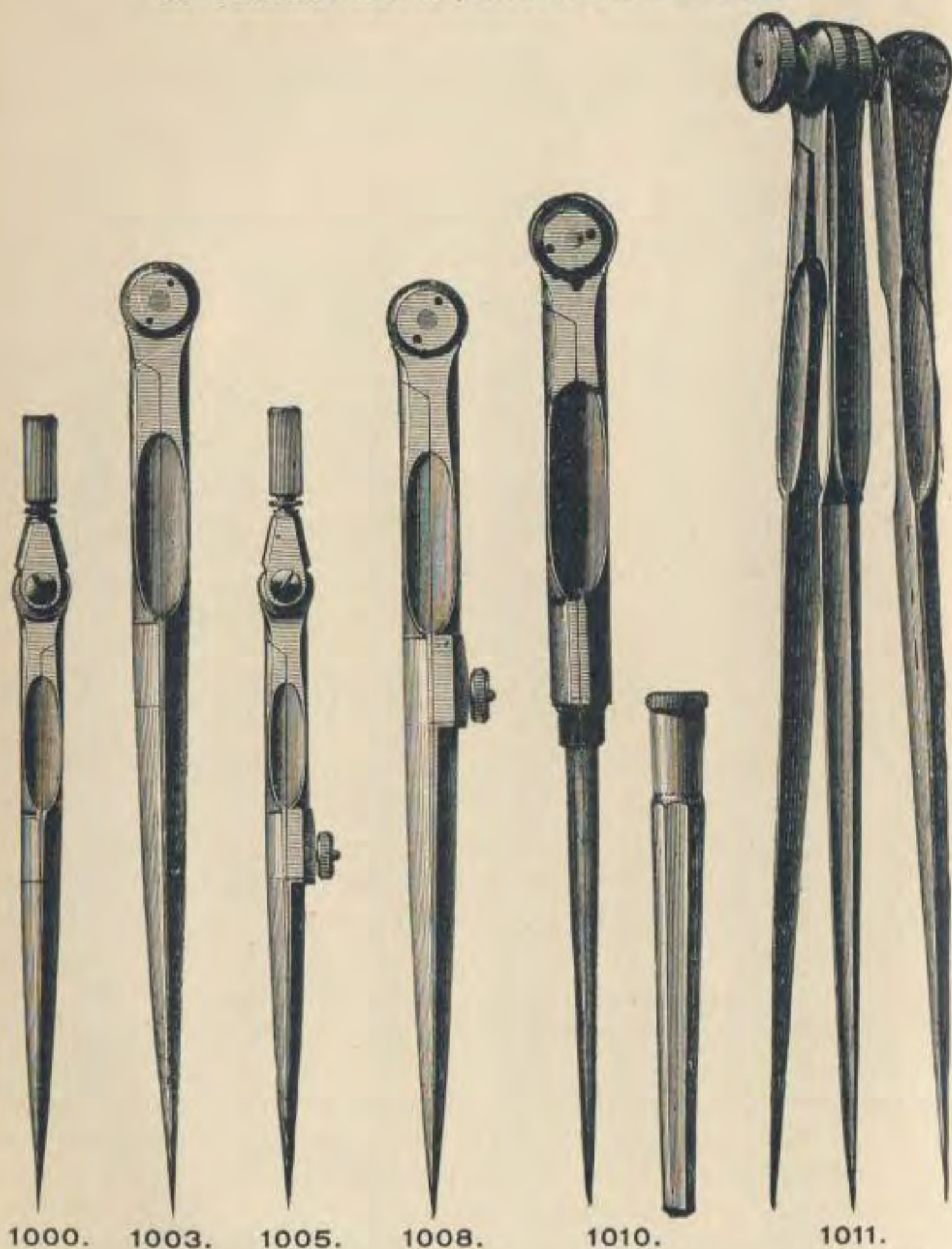

No.		PRICE.	POST.
1000.	Plain Dividers, $3\frac{1}{2}$ -inch, with handle	\$1.50	\$0.10
1002.	Plain Dividers, $4\frac{1}{2}$ -inch, without handle.....	1.50	.12
1003.	Plain Dividers, 5-inch, without handle.....	1.75	.12
1005.	Hairspring Dividers, $3\frac{1}{2}$ -inch, with handle	2.25	.10

No.		PRICE.	Post.
1007.	Hairspring Dividers, 4½-inch, without handle.....	\$2.25	\$0.12
1008.	Hairspring Dividers, 5-inch, without handle.....	2.50	.12
1010.	Pocket Dividers, 5-inch, with sheath.....	2.50	.12
1011.	Three-legged Dividers, 6-inch, for spacing off three points.....	4.00	.13
1013.	Whole and Half Dividers, 7¼-inch.....	3.50	.15

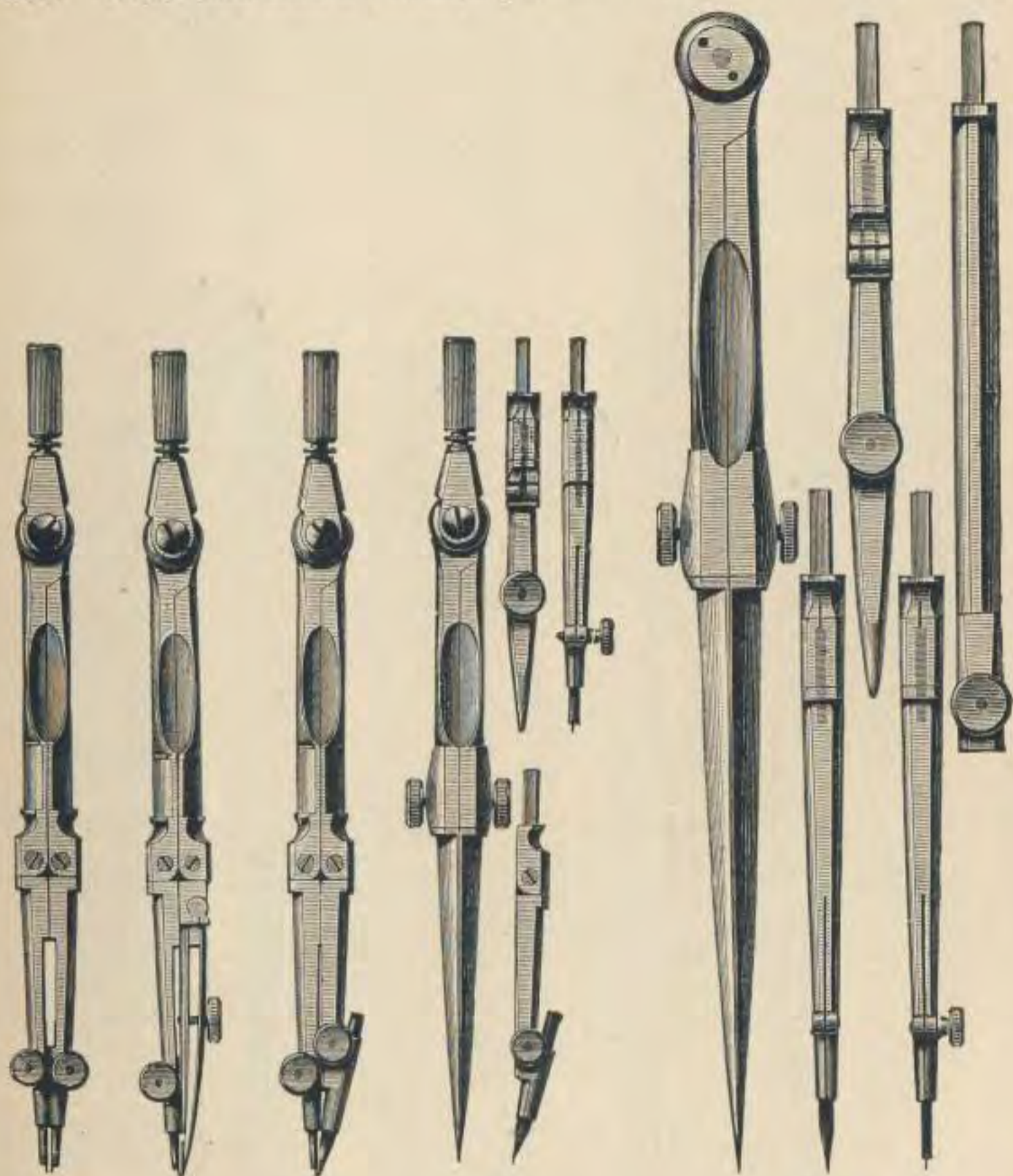

1015.	Compasses, 3½-inch, with two fixed needle points..	3.00	.10
1016.	Compasses, 3½-inch, with fixed needle and pen points	3.00	.10

No.		PRICE.	POST.
1017.	Compasses, 3½-inch, with fixed needle and pencil points	\$3.00	\$0.10
1018.	Compasses, 3½-inch, with fixed needle point, and pen and pencil points.....	4.50	.12
1019.	Compasses, 3½-inch, with pen, pencil and needle points	5.00	.12
1020.	Spring Bow-Compasses, 3½-inch, with long handle, two steel points, pencil and needle points and two pen points for ruling parallel lines.....	7.00	.13
1022.	Compasses, 5½-inch, with fixed needle point, pen and pencil points and lengthening bar	5.50	.15
1024.	Compasses, 6-inch, with pen, pencil and needle points and lengthening bar.....	6.50	.15



1026.



Folded.
1029.

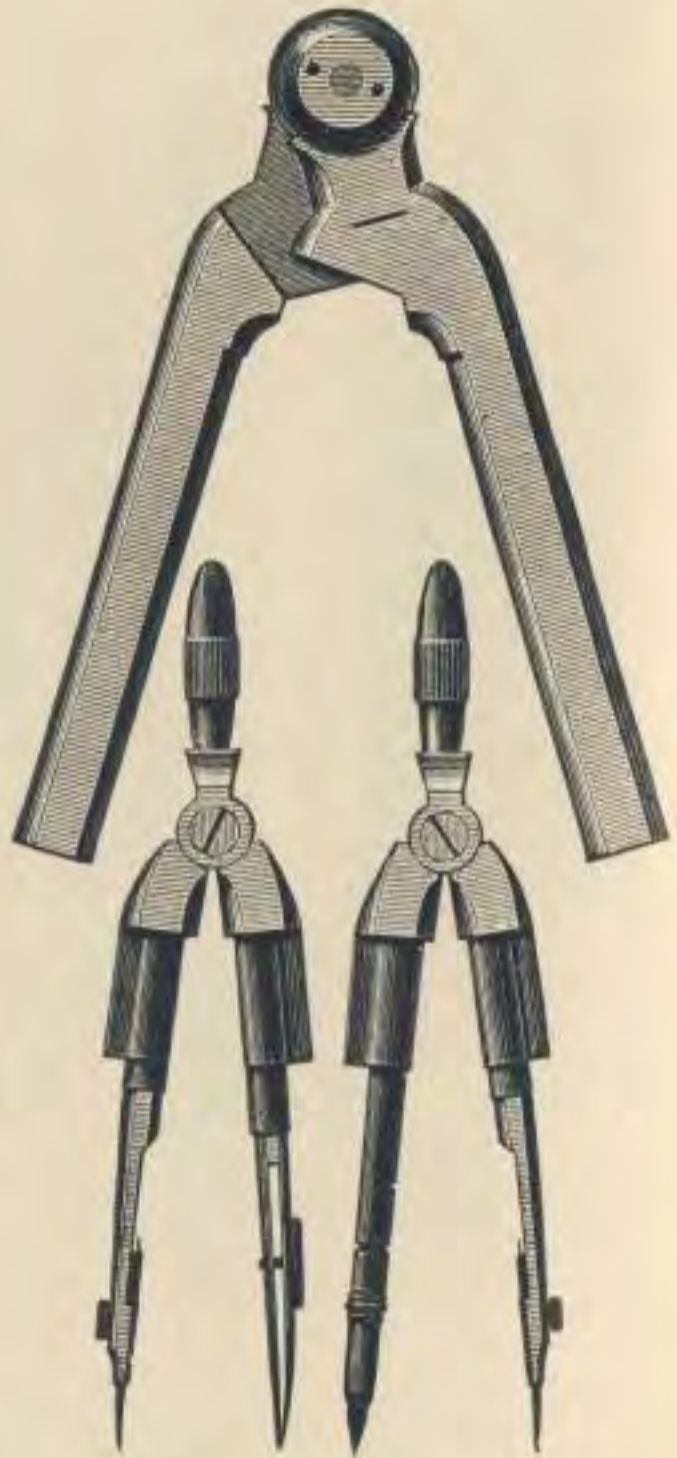

Drawn out for small circles.
1029.

No.		PRICE.	POST.
1026.	Compasses, 6½-inch, with joint in each leg, pen, pencil and needle points, dotting-pen and lengthening bar	\$9.00	\$0.18
1028.	Pocket-Compasses, with folding points.....	8.75	.12
1029.	Pillar-Compasses, with handles, pen, pencil and two needle points which can be drawn out and used as a small bow-pen and bow-pencil.....	9.75	.14



1033.



1034.



1035.

1033.	Steelspring Bow-dividers, with ivory handle, 3-inch	1.50	.10
1034.	Steelspring Bow-pen, with ivory handle, 3-inch....	2.00	.10
1035.	Steelspring Bow-pencil, with ivory handle, 3-inch..	2.00	.10
1039.	Steelspring Bow-dividers, with ivory handle, 3½-inch	2.00	.10
1040.	Steelspring Bow-dividers, with needle point, ivory handle, 3½-inch	2.50	.10
1041.	Steelspring Bow-pen, with needle point, ivory handle, 3½-inch	2.50	.10
1042.	Steelspring Bow-pencil, with needle point, ivory handle, 3½-inch	2.50	.10
1046.	Spring Bow-pen, with adjusting-screw.....	2.00	.10
1047.	Spring Bow-pen, with adjusting-screw and pencil point	3.00	.10
1048.	Spring Bow-pen, with adjustable point, for small circles	3.00	.10
1049.	Spring Bow-pen and pencil, with adjustable point, for small circles	4.00	.10



1040.



1041.

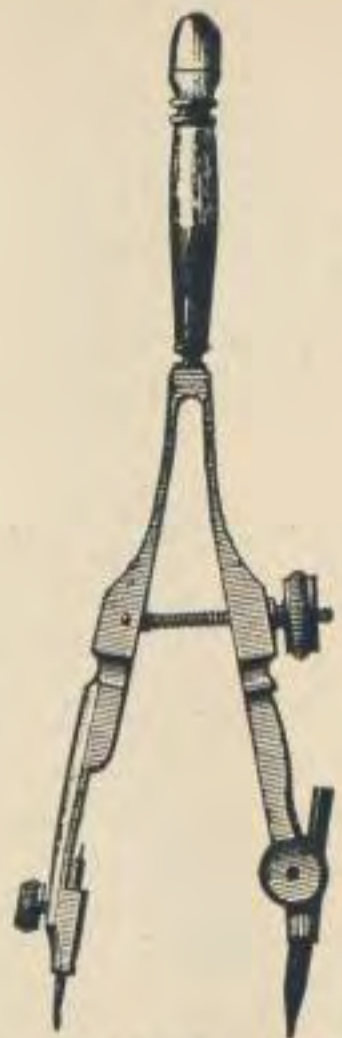

1042.



1046.



1047.



1048.



1049.

(For prices, see page 283.)

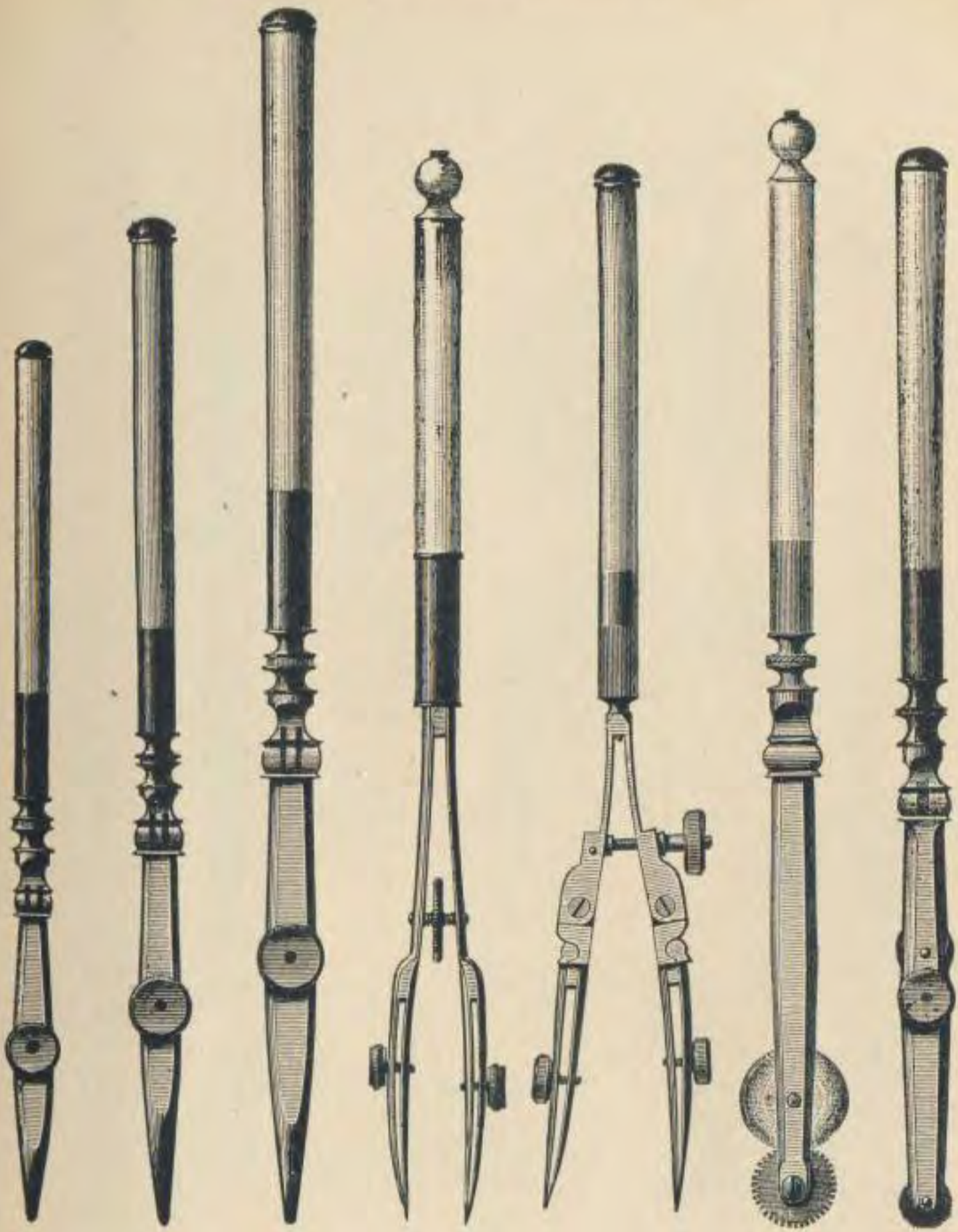

1055. 1056. 1057. 1060. 1062. 1064. 1065.

No.		PRICE.	POST.
1055.	Drawing-Pen, with joint and pin, ivory handle, 4 $\frac{3}{4}$ -inch	\$1.25	\$0.10
1056.	Drawing-Pen, with joint and pin, ivory handle, 5 $\frac{1}{2}$ -inch	1.40	.10
1057.	Drawing-Pen, with joint and pin, ivory handle, 6 $\frac{1}{2}$ -inch	1.60	.10
1060.	Railroad Pen, without joints, ivory handle, 6-inch..	2.50	.10

No.		PRICE.	POST.
1062.	Railroad Pen, with joints in blades and shanks, improved pattern, ivory handle, 5½-inch.....	\$3.00	\$0.10
1064.	Dotting-Pen, one wheel, ivory handle, 6 inch.....	1.85	.10
1065.	Dotting-Pen, six wheels, improved pattern, with ink reservoir, ivory handle, 6-inch.....	3.50	.10

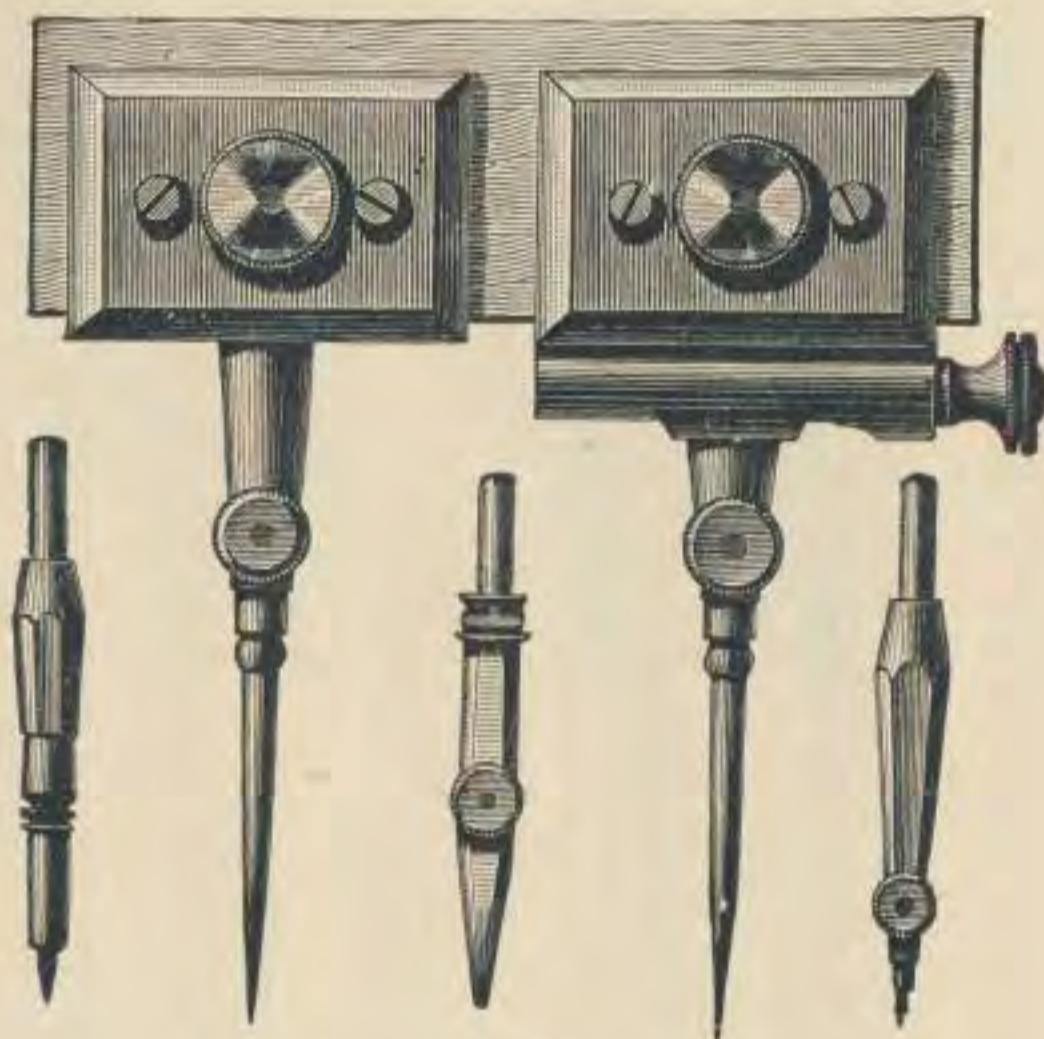

1067.

1067.	Beam-Compass Furniture, with two steel points, pen, pencil and needle points, in morocco case...	8.00	.20
1068.	Beam-Compass Furniture, with micrometer adjustment, two steel points, pen, pencil and needle points, and wheel attachment to stand alone; all in morocco case.....	13.00	.30
1069.	Hardwood Bars for No. 1067 Beam-Compass		
	24 30 36 48 inches long.		
	Each, \$0.25 \$0.30 \$0.35 \$0.50		
	Postage, .10 .12 .15 .20		
1070.	Beam-Compasses, 18-inch, in two German silver bars, with two steel points, pen, pencil and needle points.....	10.00	.20
1071.	Beam-Compasses, 24-inch, three bars, with two steel points, pen, pencil and needle points.....	11.00	.25
1072.	Beam-Compasses, 36-inch, three bars, with two steel points, pen, pencil and needle points.....	14.00	.30



1075.

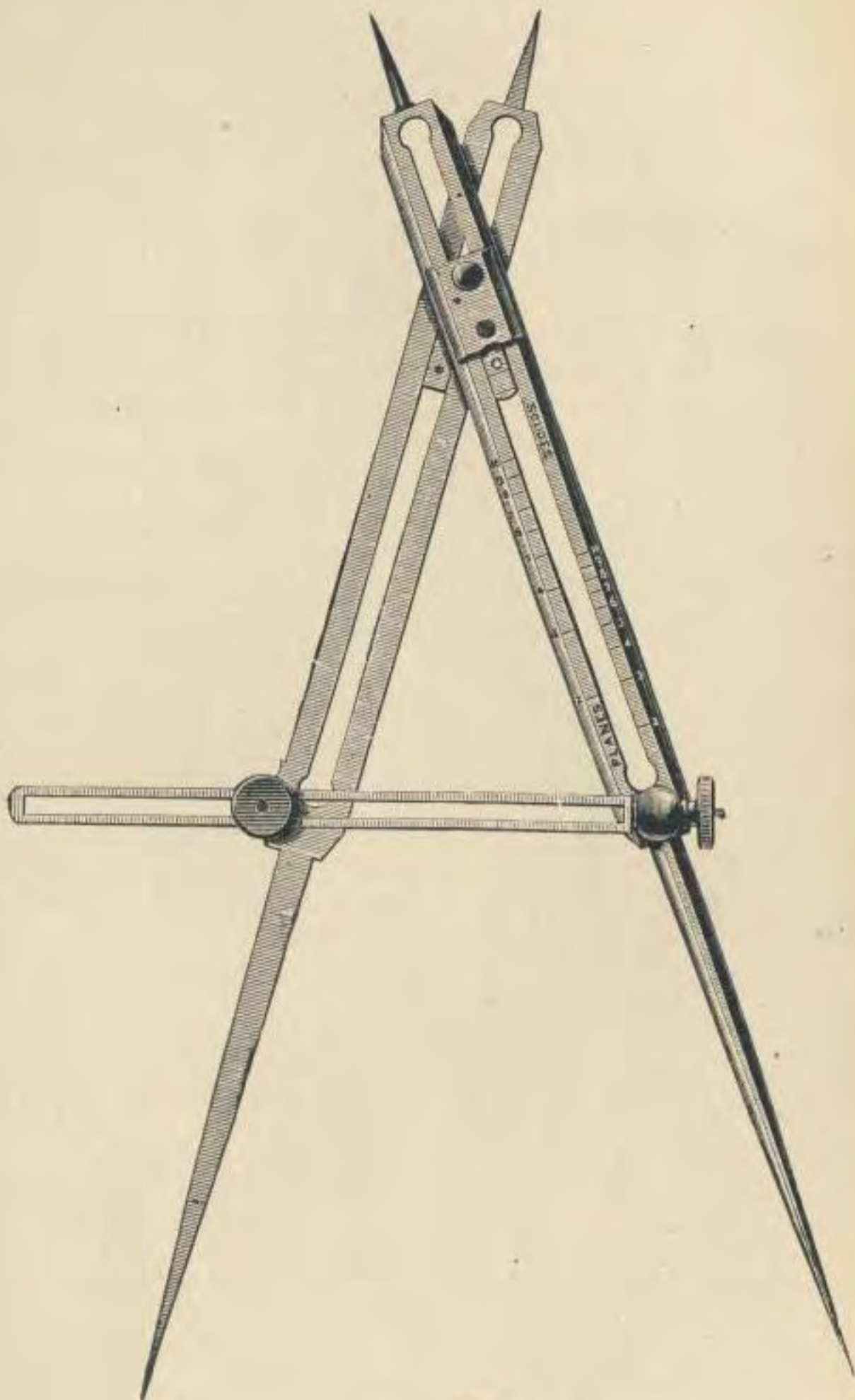

1079.

No.		PRICE.	Post.
1074.	Proportional Dividers, $7\frac{1}{8}$ -inch, divided for lines.....	\$8.00	\$0.15
1075.	Proportional Dividers, $7\frac{1}{8}$ -inch, divided for lines and circles.....	9.00	.15

No.		PRICE.	Post.
1076.	Proportional Dividers, $8\frac{3}{4}$ -inch, divided for lines and circles, and with rack and pinion movement.	\$12.00	\$0.18
1078.	Proportional Dividers, 9-inch, divided for lines and circles, and with micrometer screw.....	14.00	.20
1079.	Proportional Dividers, 9-inch, divided for lines, circles, planes and solids, and with micrometer screw.....	16.00	.20
	Morocco Cases for Proportional Dividers :		
	To fit Dividers Nos. 1074, 1075.....	.80	.10
	“ “ No. 1076.....	1.10	.12
	“ “ Nos. 1078, 1079.....	1.20	.15
1084.	Polar Planimeter, German silver, best quality, in morocco case, with printed directions.....	16.50	.25
	This Planimeter indicates up to 10 square inches.		
1086.	Polar Planimeter, German silver, best quality, in morocco case, with printed directions.....	19.00	.25
	This Planimeter indicates up to 100 square inches.		
1088.	Polar Planimeter, German silver, best quality, in morocco case, with printed directions.....	28.50	.35
	This Planimeter indicates square inches, square feet and square centimeters.		
1090.	Polar Planimeter, German silver, with the tracer-arm graduated nearly its entire length and with vernier. Easily adjusted to any desired scale. In mahogany box, with printed directions.....	33.00	.50

By means of the Polar Planimeter a person may ascertain the area of any planimetric figure more correctly and in less time than the most experienced Mathematician could calculate it.

NOTE.—The Planimeters mentioned above are the favorite styles and the best quality.

We can furnish cheaper Planimeters (to order only), but do not keep them in stock.

EMPTY CASES FOR DRAWING-INSTRUMENTS,

WITH TRAY FITTED COMPLETE, AND WITH LOCK SPACE UNDER TRAY FOR SUNDRIES.

No.	Size.	MAHOGANY CASES FITTED, WITH TRAY.			MOROCCO CASES FITTED, WITHOUT TRAY.	
		Plain.	Polished.	Postage.	Price.	Postage.
1092.....	8 x $3\frac{1}{2}$ inches.	\$2.50	\$3.25	\$0.20	\$2.25	\$0.15
1093.....	8 x 4 inches.	2.75	3.50	.20	2.50	.15
1094.....	8 x 5 inches.	3.00	3.75	.25	2.75	.18
1095.....	9 x 5 inches.	3.25	4.00	.30	3.00	.18
1096.....	10 x 6 inches.	4.00	5.00	.35	4.00	.20
1097.....	11 x 7 inches.	4.75	6.00	.50	5.00	.25
1098.....	13 x 7 inches.	5.75	7.00	.75	6.00	.50

Other sizes made to order.

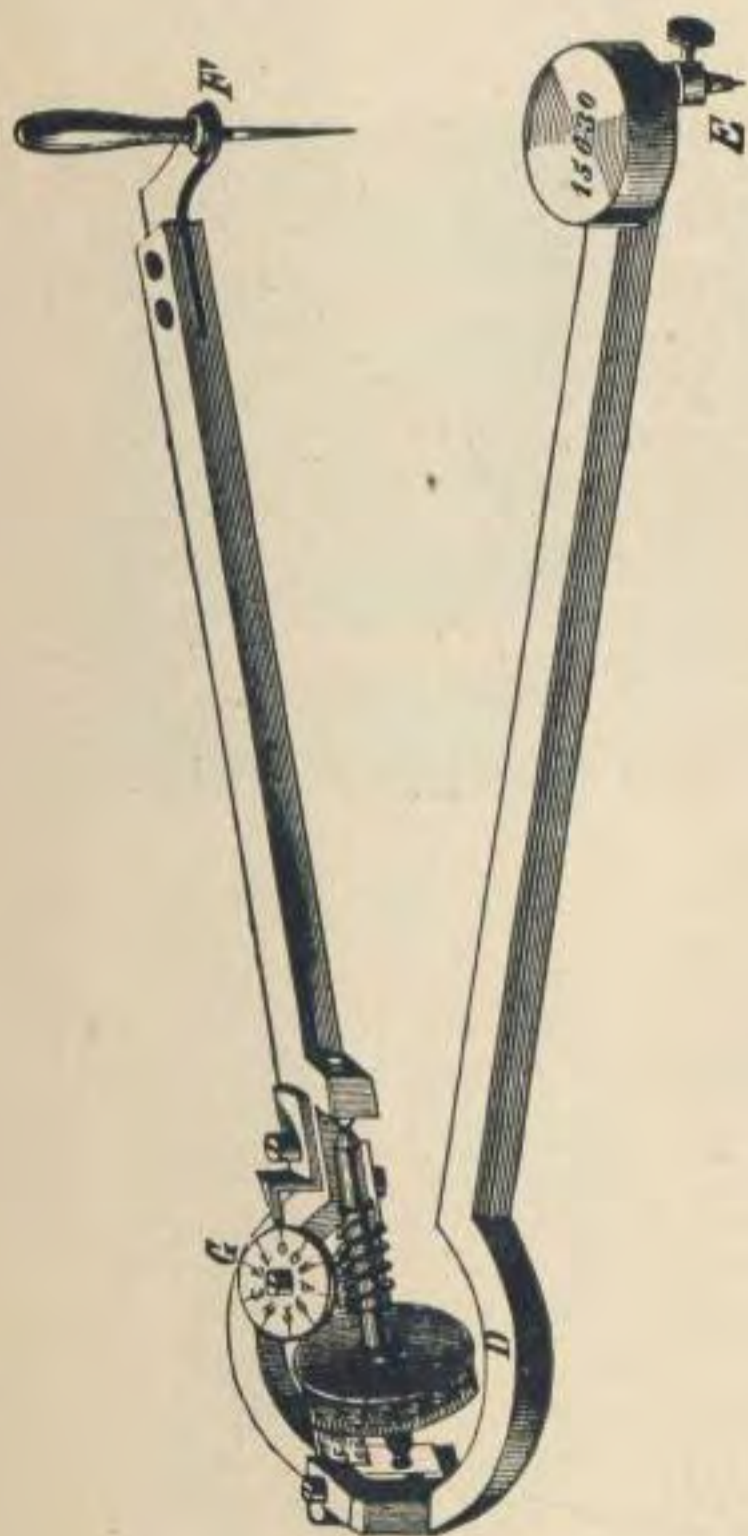

1086.

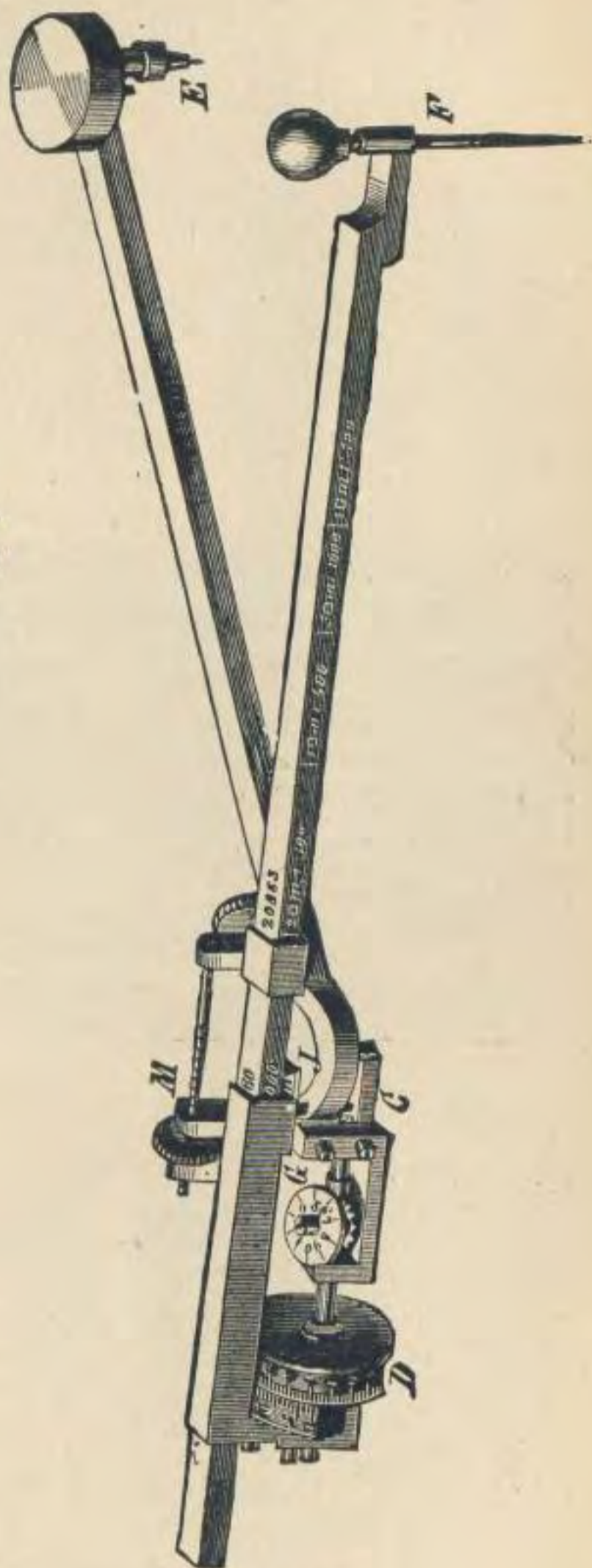

1088.

(See page 288.)

SETS OF EXTRA FINE SWISS DRAWING- INSTRUMENTS IN CASES.

No.		PRICE.	POST.
1100.	Morocco Case, containing : Hairspring Dividers, No. 1005 ; Compasses, No. 1019 ; Bow-pen, No. 1034 ; Drawing-Pen, No. 1055 ; Box of Leads.....	\$13.00	\$0.15
1102.	Morocco Case, containing : Hairspring Dividers, No. 1008 ; Compasses, No. 1024 ; Bow-pen, No. 1041 ; Drawing-Pens, Nos. 1055 and 1057 ; Box of Leads	17.00	.20



1104.

1104.	Morocco Case, containing : Hairspring Dividers, No. 1008 ; Compasses, No. 1024 ; Bow-spacer, No. 1039 ; Bow-pen, No. 1041 ; Bow-pencil, No. 1042 ; Drawing-Pens, Nos. 1055 and 1057 ; Box of Leads.....	22.00	.25
1105.	Polished Mahogany Box, with lock and tray, containing : Hairspring Dividers, No. 1008 ; Compasses, Nos. 1019 and 1024 ; Drawing-Pens, Nos. 1055 and 1056 ; Box of Leads.....	21.00	.40
1106.	Polished Mahogany Box, with lock and tray, containing : Plain Dividers, No. 1003 ; Hairspring Dividers, No. 1008 ; Compasses, Nos. 1018 and 1022 ; Bow-spacer, No. 1033 ; Bow-pen, No. 1034 ; Bow-pencil, No. 1035 ; Drawing-Pens, Nos. 1055 and 1056 ; Box of Leads	27.00	.45

SUPERIOR SWISS DRAWING-INSTRUMENTS,
WITH PERFECT PIVOT-JOINTED HEADS.

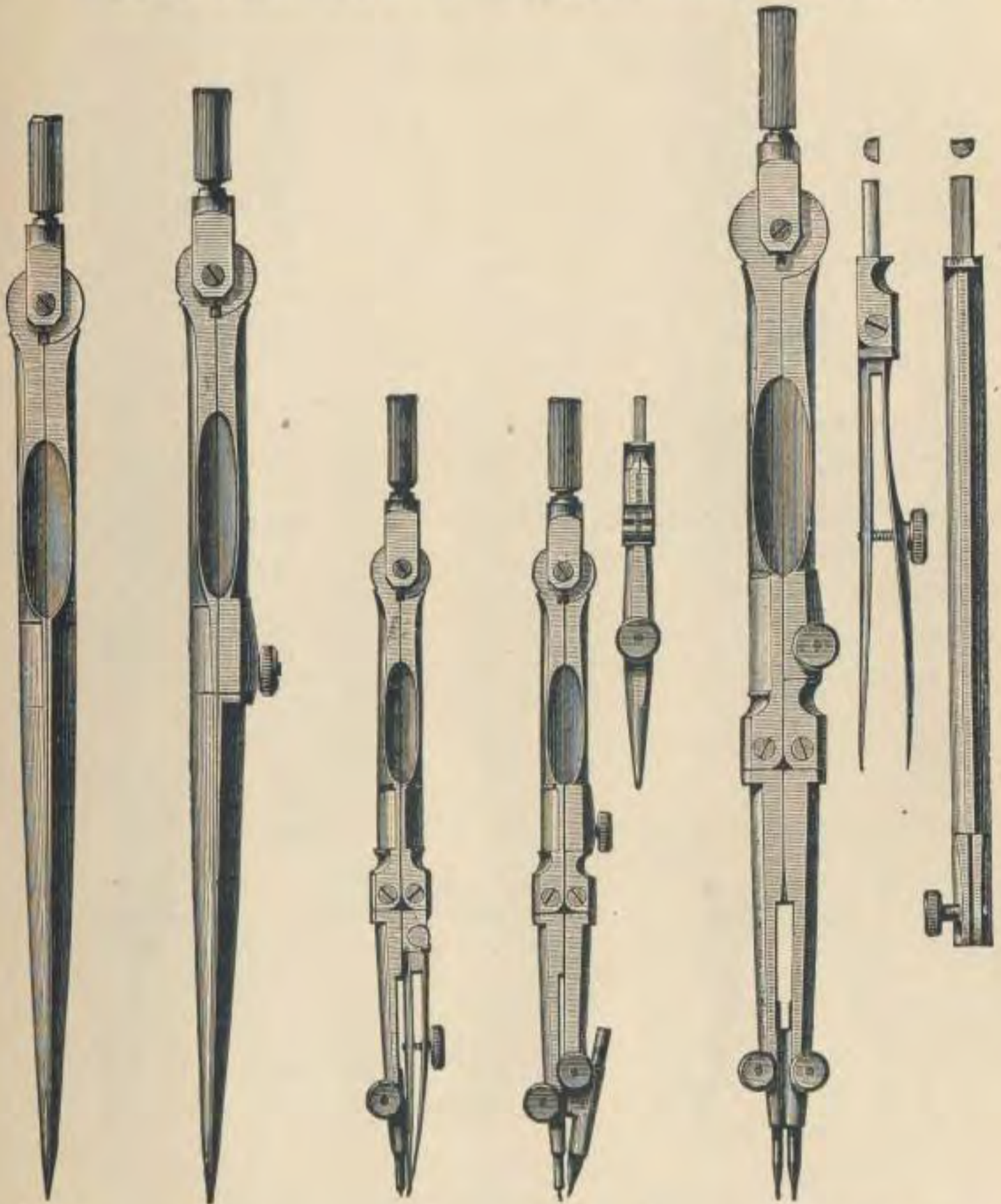

1112.

1116.

1119.

1122.

1130.

No.		PRICE.	POST.
1110.	Plain Dividers, 3½-inch.....	\$2.00	\$0.10
1111.	Plain Dividers, 4½-inch.....	2.35	.12
1112.	Plain Dividers, 5-inch.....	2.50	.12
1114.	Hairspring Dividers, 3½-inch.....	2.50	.10

No.		PRICE.	POST.
1115.	Hairspring Dividers, 4½-inch.....	\$3.00	\$0.12
1116.	Hairspring Dividers, 5-inch.....	3.25	.12
1119.	Compasses, 3½-inch, with fixed needle and pen points.....	3.35	.10
1120.	Compasses, 3½-inch, with fixed needle and pencil points.....	3.35	.10
1122.	Compasses, 3½-inch, with fixed needle point, and pen and pencil points.....	5.00	.12
1124.	Compasses, 3½-inch, with fixed needle point with hairspring, and pen and pencil points.....	6.00	.12
1126.	Compasses, 4½-inch, with fixed needle point, pen and pencil points and lengthening bar.....	6.25	.15
1128.	Compasses, 4½-inch, with fixed needle point with hairspring, pen and pencil points and lengthening bar.....	7.25	.15
1130.	Compasses, 5½-inch, with fixed needle point, pen and pencil points and lengthening bar.....	6.50	.15
1132.	Compasses, 5½-inch, with fixed needle point with hairspring, pen and pencil points and lengthening bar.....	7.50	.15



1135.



1137.



1138.

1135.	Steelspring Bow-spacer, 3-inch, with metal handle..	1.50	.10
1137.	Steelspring Bow-pen, 3-inch, with metal handle....	2.25	.10
1138.	Steelspring Bow-pencil, 3-inch, with metal handle..	2.25	.10
1140.	Steelspring Bow-spacer, 3½-inch, with wheel adjustment.....	2.00	.10
1142.	Steelspring Bow-pen, 3½-inch, with wheel adjustment.....	2.75	.10



1132.

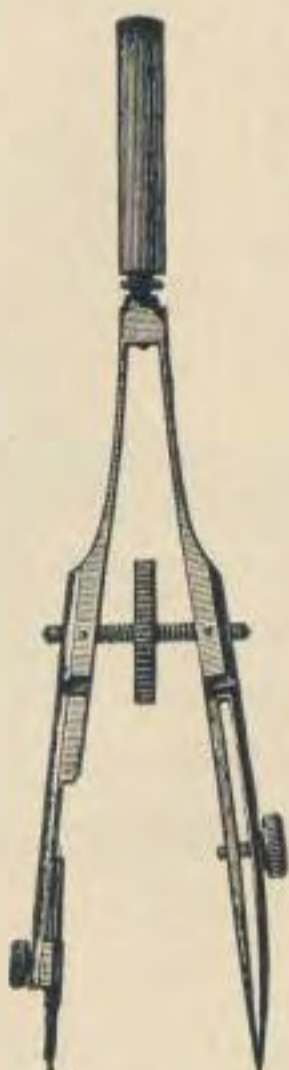

1142.



1140.



1143.



1147.



1148.

(For prices, see pages 292 and 294.)

No.		PRICE.	POST.
1143.	Steelspring Bow-pencil, $3\frac{1}{2}$ -inch, with wheel adjustment	\$2.75	\$0.10
1147.	Drawing-Pen, with spring blade, ebony handle, $4\frac{1}{2}$ -inch	1.10	.10
1148.	Drawing-Pen, with spring blade, ebony handle, 5-inch	1.20	.10
1149.	Drawing-Pen, with spring blade, ebony handle, $5\frac{1}{2}$ -inch	1.35	.10

CASES OF SWISS DRAWING-INSTRUMENTS, WITH PIVOT-JOINTED HEADS.

1160.	Morocco Case, containing : Plain Dividers, No. 1110 ; Compasses, No. 1122 ; Drawing-Pen, No. 1147 ; Box of Leads.....	\$9.00	\$0.15
1161.	Morocco Case, containing : Hairspring Dividers, No. 1115 ; Compasses, No. 1126 ; Drawing-Pen, No. 1148 ; Box of Leads...	12.00	.15

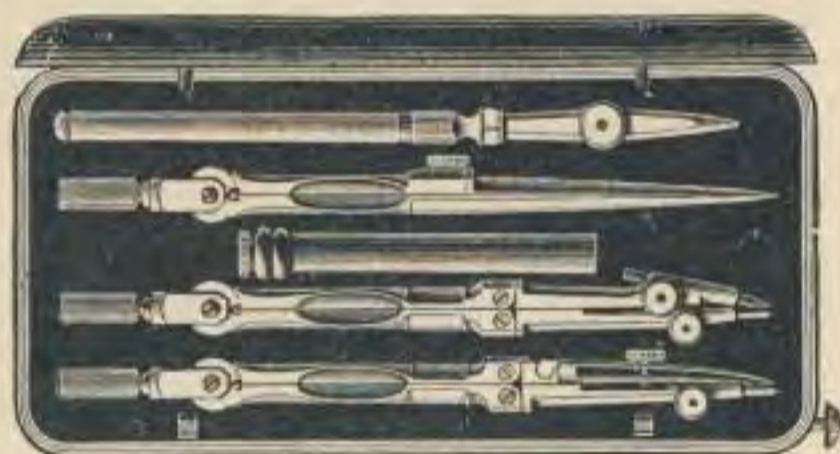

1162.

1162.	Morocco Case, containing : Hairspring Dividers, No. 1114 ; Compasses, Nos. 1119 and 1120 ; Drawing-Pen, No. 1147 ; Box of Leads.....	12.00	.15
1163.	Morocco Case, containing : Hairspring Dividers, No. 1115 ; Compasses, No. 1126 ; Bow-pen, No. 1137 ; Drawing-Pens, Nos. 1147 and 1148 ; Box of Leads.....	16.00	.20
1164.	Morocco Case, containing : Hairspring Dividers, No. 1116 ; Compasses, Nos. 1124 and 1130 ; Drawing-Pens, Nos. 1147 and 1148 ; Box of Leads.....	20.00	.20

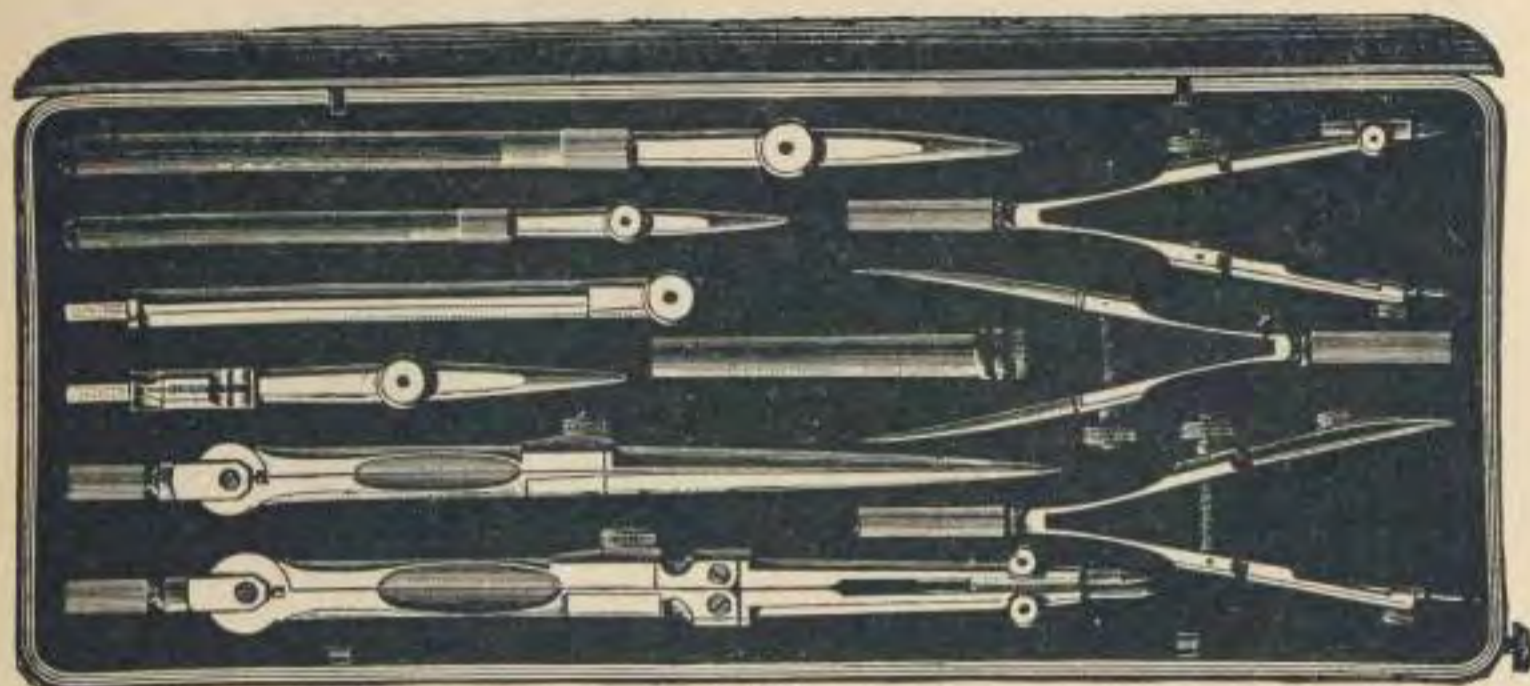

1166.

No.		PRICE.	POST.
1166.	Morocco Case, containing: Hairspring Dividers, No. 1115; Compasses, No. 1126; Bow-spacer, No. 1135; Bow-pen, No. 1137; Bow-pencil, No. 1138; Drawing-Pens, Nos. 1147 and 1148; Box of Leads	\$20.00	\$0.20
1167.	Morocco Case, containing: Hairspring Dividers, No. 1116; Compasses, Nos. 1124 and 1130; Bow-pen, No. 1137; Drawing-Pens, Nos. 1147, 1148 and 1149; Box of Leads..	24.00	.25
1168.	Folding Pocket Case with flexible flaps (see page 301), and containing same instruments as in set No. 1166.....	21.25	.20

ALTENEDER'S PATENT JOINT GERMAN SILVER AND STEEL DRAWING-INSTRUMENTS.

(WARRANTED GENUINE.)

The excellence of these instruments consists in the joints of the dividers being so constructed as to prevent any irregular motion when the legs are opened or closed, also for the general care with which the instruments are finished. All the pens are well made and pointed.

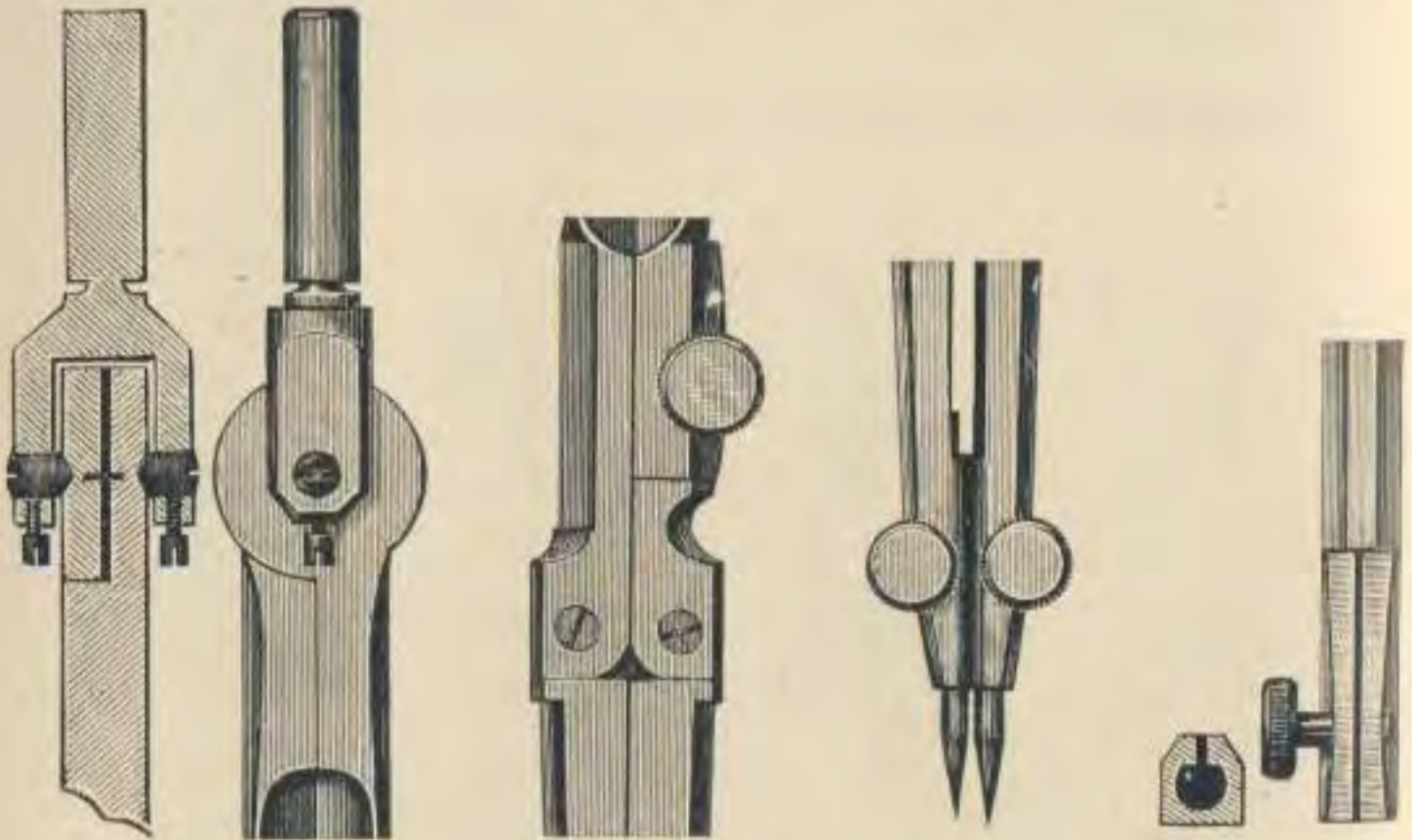

Alteneder's Patent Joint.

Knuckle-Joints.

Clamp-Holders

Clamp-Sockets.

No.		PRICE.	POST.
1170.	Plain Dividers, 3½-inch.....	\$ 2.25	\$0.10
1171.	Plain Dividers, 4½-inch.....	2.50	.12
1172.	Plain Dividers, 5-inch.....	2.50	.12
1174.	Hairspring Dividers, 3½-inch.....	3.50	.10
1175.	Hairspring Dividers, 4½-inch.....	3.75	.12
1176.	Hairspring Dividers, 5-inch.....	4.00	.12
1180.	Compasses, 3½-inch, with fixed needle and pen points.....	4.00	.10
1181.	Compasses, 3½-inch, with fixed needle and pencil points.....	4.00	.10
1182.	Compasses, 4½-inch, with fixed needle and pen points	4.50	.12
1183.	Compasses, 4½-inch, with fixed needle and pencil points	4.50	.12

(See cuts on pages 297 and 298.)

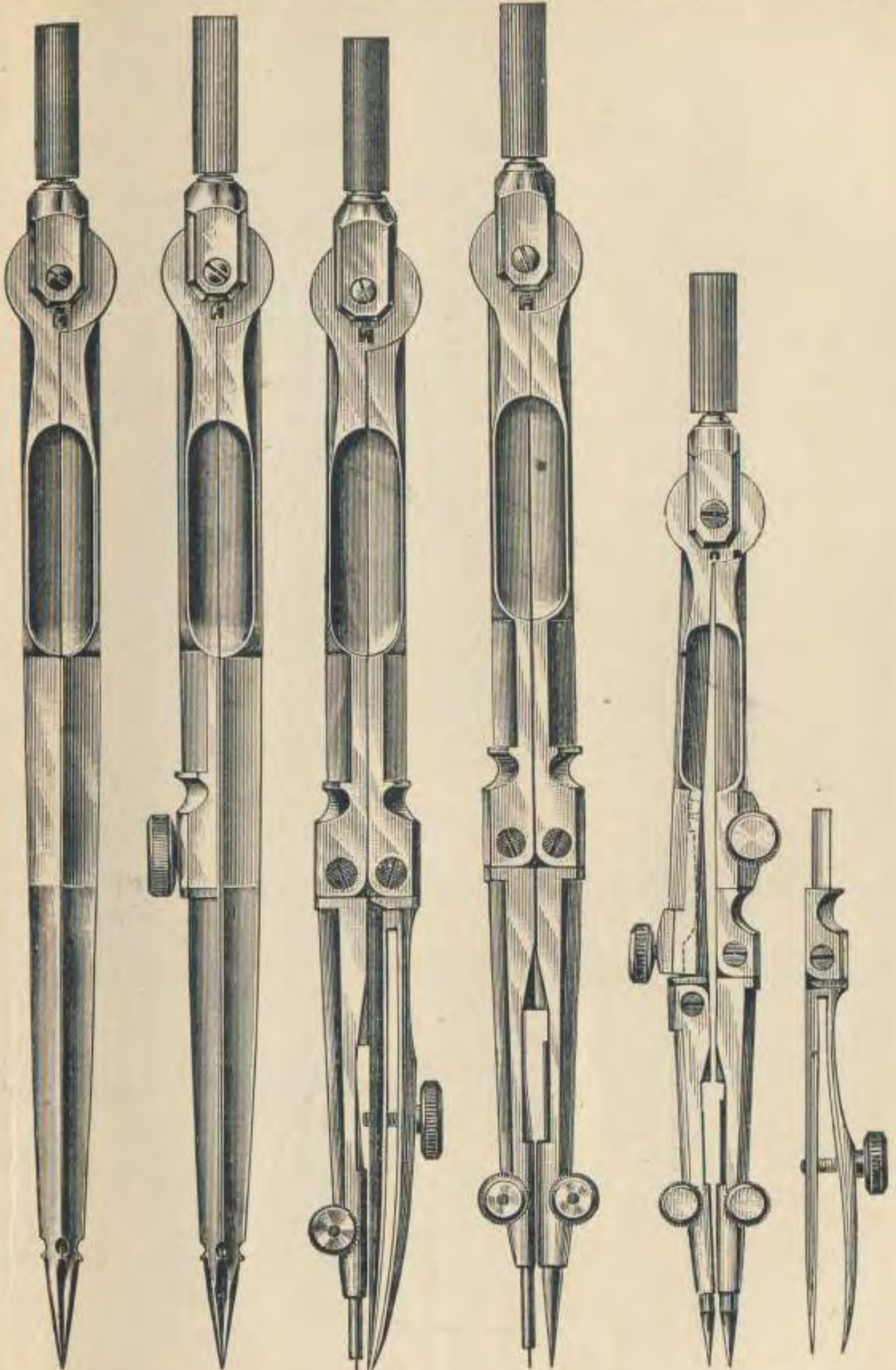

1171.

1175.

1182.

1183.

1187.

(For prices, see pages 296 and 299.)



1190.



1195.



1196.



1197.



1198.

(For prices, see page 299.)

No.		PRICE.	POST.
1184.	Compasses, 5½-inch, with fixed needle and pen points	\$5.00	\$0.12
1185.	Compasses, 5½-inch, with fixed needle and pencil points	5.00	.12
1186.	Compasses, 3½-inch, with fixed needle point, and pen and pencil points.....	6.00	.12
1187.	Compasses, 3½-inch, with fixed needle point with hairspring, and pen and pencil points.	7.50	.12
	(See cut of No. 1187 on page 297.)		
1188.	Compasses, 4½-inch, with fixed needle point, and pen and pencil points and lengthening bar.....	7.25	.14
1189.	Compasses, 4½-inch, with fixed needle point with hairspring, and pen and pencil points and lengthening bar.....	8.75	.14
1190.	Compasses, 5½-inch, with fixed needle point, pen and pencil points and lengthening bar.....	7.50	.15
1191.	Compasses, 5½-inch, with fixed needle point with hairspring, pen and pencil points and lengthening bar	9.00	.15
1195.	Steelspring Bow-spacer, metal handle, 3-inch.....	1.75	.10
1196.	Steelspring Bow-spacer, needle-points, metal handle, 3-inch.....	2.50	.10
1197.	Steelspring Bow-pen, needle point, metal handle, 3-inch.....	2.50	.10
1198.	Steelspring Bow-pencil, needle point, metal handle, 3-inch	2.50	.10
	(See cuts of Nos. 1190-1198 on page 298.)		

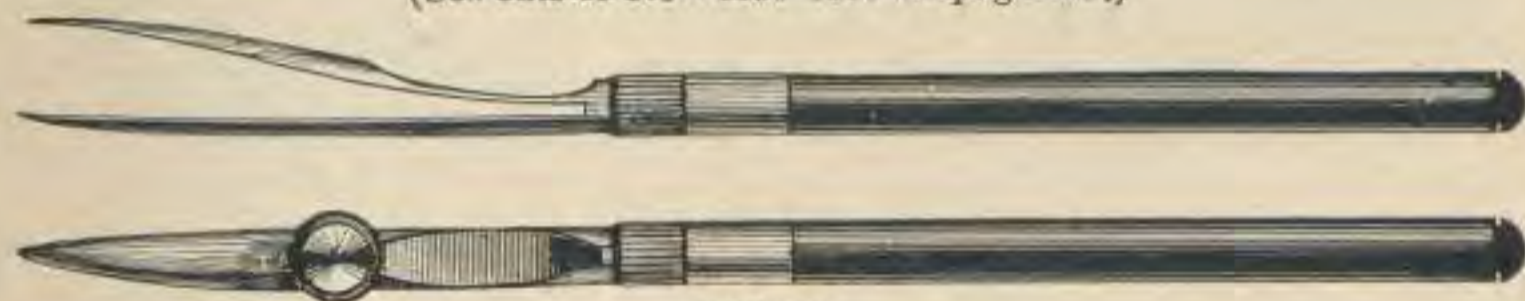

1206.

1206.	Drawing-Pen, with spring blade, ebony handle, 4¼-inch	1.40	.10
1207.	Drawing-Pen, with spring blade, ebony handle, 5-inch	1.65	.10
1208.	Drawing-Pen, with spring blade, ebony handle, 5½-inch	1.90	.10
1209.	Drawing-Pen, with patent spring hinge, ebony handle, 5-inch.....	2.90	.10
1210.	Railroad Pen, ebony handle, 5-inch.....	3.50	.10
1211.	Swivel Curve-Pen, spring blade, hollow metal handle	2.00	.10
1212.	Pricker, with removable needle point, ebony handle,	1.00	.10
1214.	Nickel-plated case, for leads.....	.15	.02

ALTENEDER'S PATENT JOINT DRAWING - INSTRUMENTS IN MOROCCO CASES.

No.		PRICE.	POST.
1220.	Morocco Case containing: Compasses, Nos. 1180 and 1181 ; Drawing-Pen, No. 1206 ; Box of Leads	\$10.75	\$0.15
1222.	Morocco Case, containing: Hairspring Dividers, No. 1175 ; Compasses, No. 1188 ; Drawing-Pen, No. 1207 ; Box of Leads..	14.25	.18
1224.	Morocco Case, containing: Hairspring Dividers, No. 1175 ; Compasses, No. 1189 ; Bow-pen, No. 1197 ; Drawing-Pen, No. 1207 ; Box of Leads.....	18.50	.20



1225.

1225.	Morocco Case, containing: Hairspring Dividers, No. 1176 ; Compasses, No. 1190 ; Bow-spacer, No. 1195 ; Bow-pen, No. 1197 ; Bow-pencil, No. 1198 ; Drawing - Pens, Nos. 1206 and 1207 ; Box of Leads.....	23.50	.20
1227.	Morocco Case, containing: Hairspring Dividers, No. 1176 ; Compasses, No. 1191 ; Bow-spacer, No. 1195 ; Bow-pen, No. 1197 ; Bow-pencil, No. 1198 ; Drawing - Pens, Nos. 1206 and 1207 ; Box of Leads.....	25.00	.25
1228.	Morocco Case, containing: Hairspring Dividers, No. 1176 ; Compasses, Nos. 1186 and 1190 ; Bow-spacer, No. 1195 ; Bow- pen, No. 1197 ; Bow-pencil, No. 1198 ; Drawing- pens, Nos. 1206 and 1207 ; Box of Leads.....	30.00	.30



CLOSED.

1230.

No.		PRICE.	POST.
1230.	Leather Pocket Case, with flexible flaps, and containing same instruments as in set No. 1225.....	\$24.75	\$0.20
1232.	Empty Leather Pocket Case, with flexible flaps, and fitted to receive from five to twelve pieces of drawing-instruments; price, according to size of case.....	PRICE. \$3.00 to \$4.00	POST. \$0.12 to \$0.20

NOTE.—Leather Pocket Cases furnished instead of the usual Morocco Cases, with sets Nos. 1220 - 1228, at an extra cost of \$1.25.

BEST GERMAN DRAWING-INSTRUMENTS.

OF FINE GERMAN SILVER AND STEEL.

(For prices of empty cases for Drawing-Instruments, see page 288.)

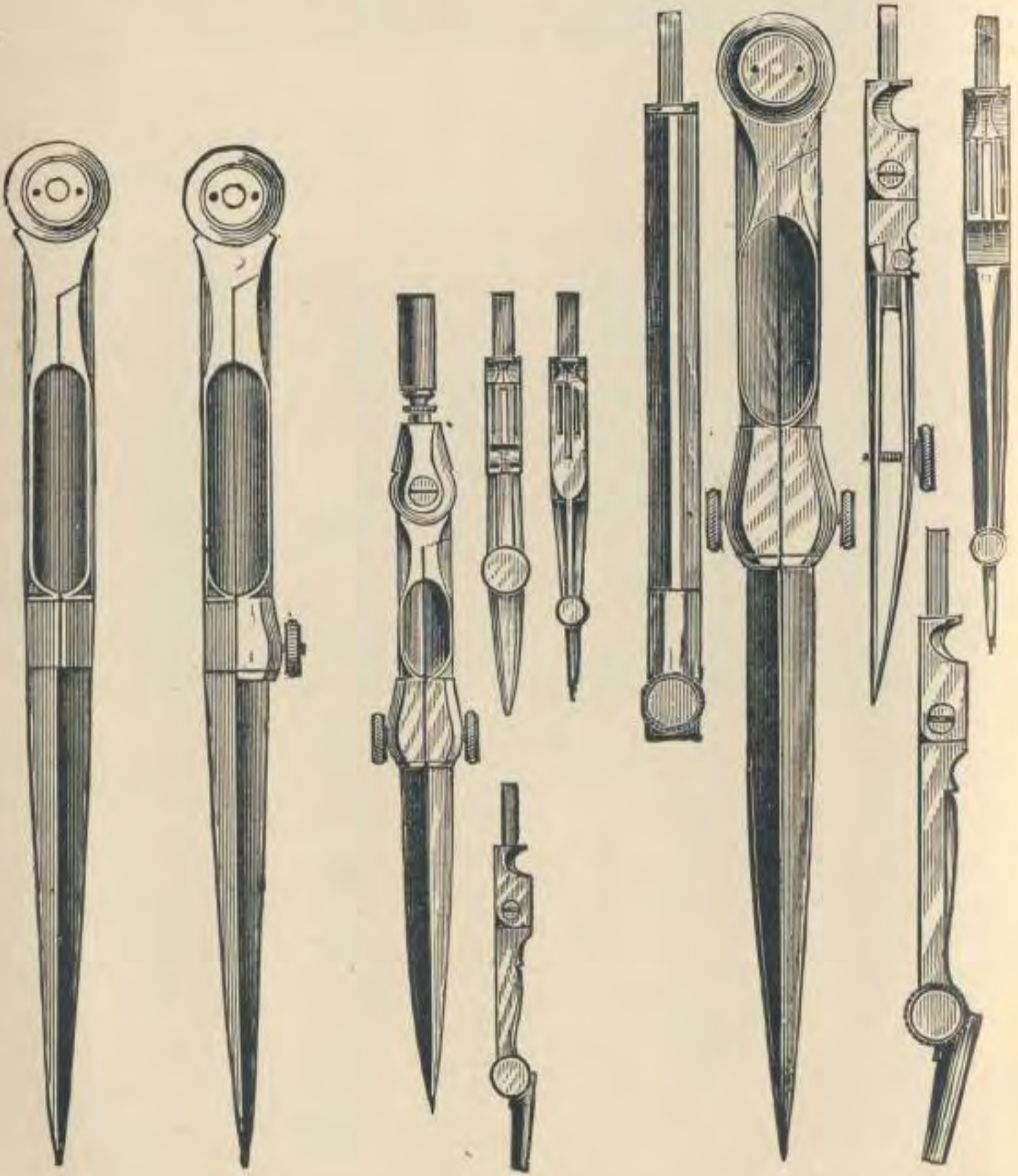

1237.

1241.

1245.

1247.

(For prices, see page 303. Nos. 1237, 1241 and 1247 are now made with handles.)

No.		PRICE.	POST.
1235.	Plain Dividers, 3½-inch, with handle.....	\$0.70	\$0.02
1236.	Plain Dividers, 4-inch, with handle.....	.75	.02
1237.	Plain Dividers, 5-inch, with handle.....	.80	.03
1238.	Plain Dividers, 6-inch, with handle.....	1.00	.04
1240.	Hairspring Dividers, 4-inch, with handle.....	1.20	.10
1241.	Hairspring Dividers, 5-inch, with handle.....	1.50	.11
1242.	Hairspring Dividers, 6-inch, with handle.....	1.75	.12
1245.	Compasses, 3½-inch, with pen, pencil and needle points.....	2.50	.12
1247.	Compasses, 5½-inch, with pen, pencil and needle points and lengthening bar.....	3.00	.15



1250.



1251.



1253.

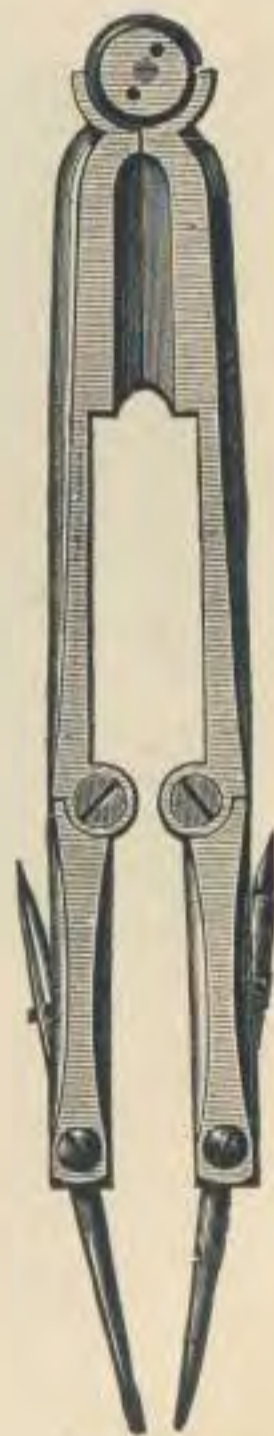

1257.

No.		PRICE.	POST.
1250.	Pocket Dividers, 5-inch with sheath.....	\$1.50	\$0.12
1251.	Three-legged Dividers, 5-inch, for taking off three points.....	2.75	.13
1253.	Proportional Dividers, 6½-inch, divided for lines.....	2.50	.15
1254.	Proportional Dividers, 7-inch, for lines and circles.	3.25	.15
1255.	Proportional Dividers, 7-inch, with rack movement and divided for lines and circles.....	5.20	.15
1257.	Pocket Compasses, with folding points.....	5.00	.12



1259.



1260.

1259.	Beam-Compass Furniture, with pen, pencil and needle points, in morocco case.....	5.00	.16
1260.	Universal Map-Measurer. The index-hand registers inches to miles, or centimeters to kilometers.....	3.00	.12
1267.	Steelspring Bow-spacer, ivory handle, 3½-inch.....	1.00	.10
1268.	Steelspring Bow-pen, ivory handle, 3½-inch.....	1.25	.10
1269.	Steelspring Bow-pencil, ivory handle, 3½-inch.....	1.25	.10



1267.



1268.



1269.



1270.

No.		PRICE.	POST.
1270.	Set of three Steel Bows, Nos. 1267, 1268 and 1269 in morocco case.....	\$4.20	\$0.15
1275.	Bow-spacer, with wheel adjustment, metal handle, 3½-inch.....	1.50	.10
1276.	Bow-pen, with wheel adjustment, metal handle 3½-inch.....	1.75	.10
1277.	Bow-pencil, with wheel adjustment, metal handle, 3½-inch.....	1.75	.10
1278.	Set of three Steel Bows, Nos. 1275, 1276 and 1277 in morocco case.....	5.75	.15



1275.



1276.



1277.

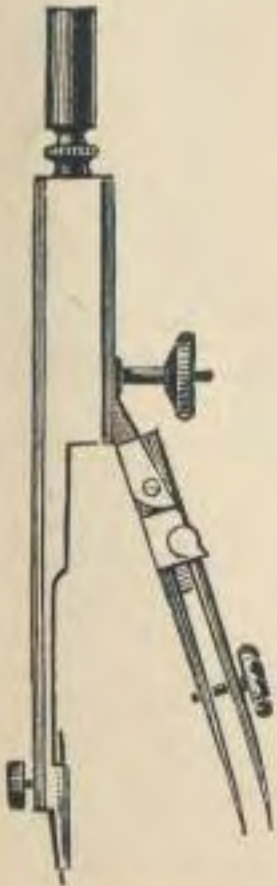

1279.

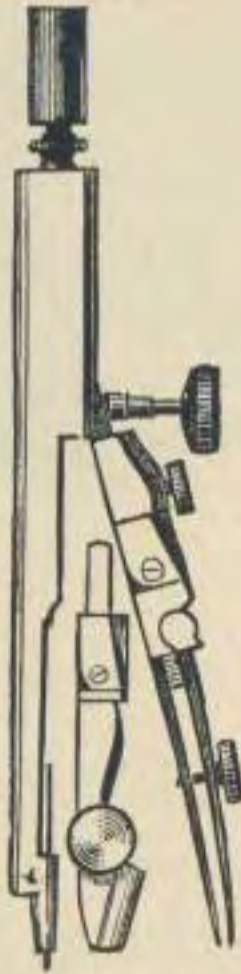

1280.



1282.



1283.

(For prices, see pages 305 and 307.)

No.		PRICE.	Post.
1279.	Spring Bow-pen, with adjusting-screw.....	\$1.40	\$0.10
1280.	Spring Bow-pen, with pencil leg and adjusting-screw	2.00	.10
1282.	Spring Bow-pen, with adjustable needle point for small circles.....	2.50	.10
1283.	Spring Bow-pen, with pencil leg, and adjustable needle point for small circles.....	3.50	.10
1284.	Spring Bow-pen, with spring needle point for small circles.....	2.75	.10
1290.	Drawing-Pen, without joint, ivory handle, 4½-inch..	.35	.02
1292.	Drawing-Pen, without joint, ivory handle, 5½-inch..	.40	.03
1294.	Drawing-Pen, with fine joint, ivory handle, 4½-inch	.50	.02
1295.	Drawing-Pen, with fine joint, ivory handle, 5-inch..	.55	.03
1296.	Drawing-Pen, with fine joint, ivory handle, 5½-inch	.60	.03

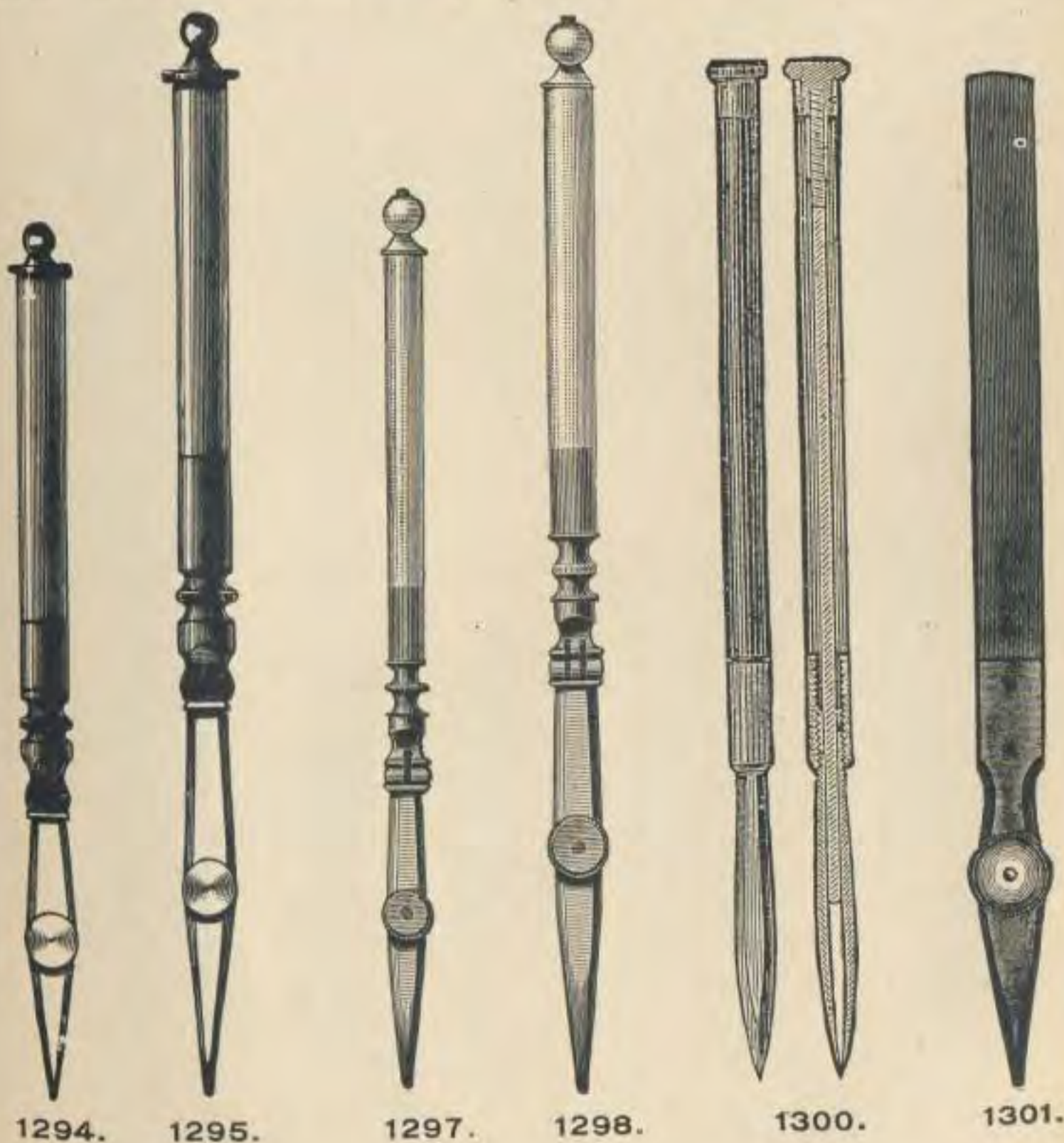

No.		PRICE.	POST.
1297.	Drawing-Pen, with fine joint and pin, ivory handle, 4½-inch.....	\$0.65	\$0.02
1298.	Drawing-Pen, with fine joint and pin, ivory handle, 5-inch70	.03
1299.	Drawing-Pen, with fine joint and pin, ivory handle, 5½—6-inch75	.03
1300.	Drawing-Pen, without set-screw, hollow metal handle, 5½-inch.....	1.45	.10
1301.	Drawing-Pen, Swedish pattern, ebony handle, 5-inch75	.03
1302.	Drawing-Pen, Swedish pattern, ebony handle, 6-inch85	.03
1303.	Drawing-Pen, with German silver blades, for red ink, 5-inch65	.03
1304.	Curve-Pen, ivory handle, 4½-inch	1.25	.10
1305.	Curve-Pen, swivel blade, hollow metal handle, 5-inch	1.50	.10
1306.	Drawing-Pen, for heavy border lines, ivory handle, 5½-inch	2.00	.10
1307.	Railroad Pen, with joints, ivory handle, 5½-inch....	2.25	.10
1308.	Railroad Pen, with ebony handle, 5½-inch, will draw with one stroke one broad or two parallel lines of the same or different widths.....	3.00	.10
1310.	Pricker, ivory handle.....	1.20	.10
1312.	Tracer, ivory handle90	.02
1314.	Dotting-Pen, one wheel, ivory handle, 5-inch.....	1.00	.03
1316.	Dotting-Pen, with six wheels, extra fine, in Morocco case.....	3.75	.12

The outer wheel is rolled on the edge of a ruler and turns the ratchet wheel, which causes the pen to move up and down. The flat point near the pen must slide on the paper.

(For cuts of Nos. 1304-1316, see page 309.)

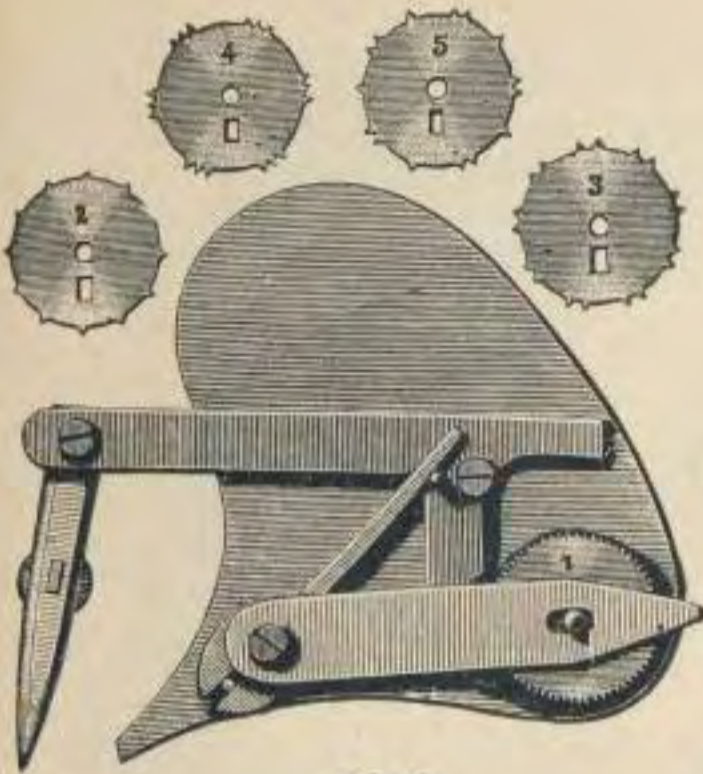

1316.

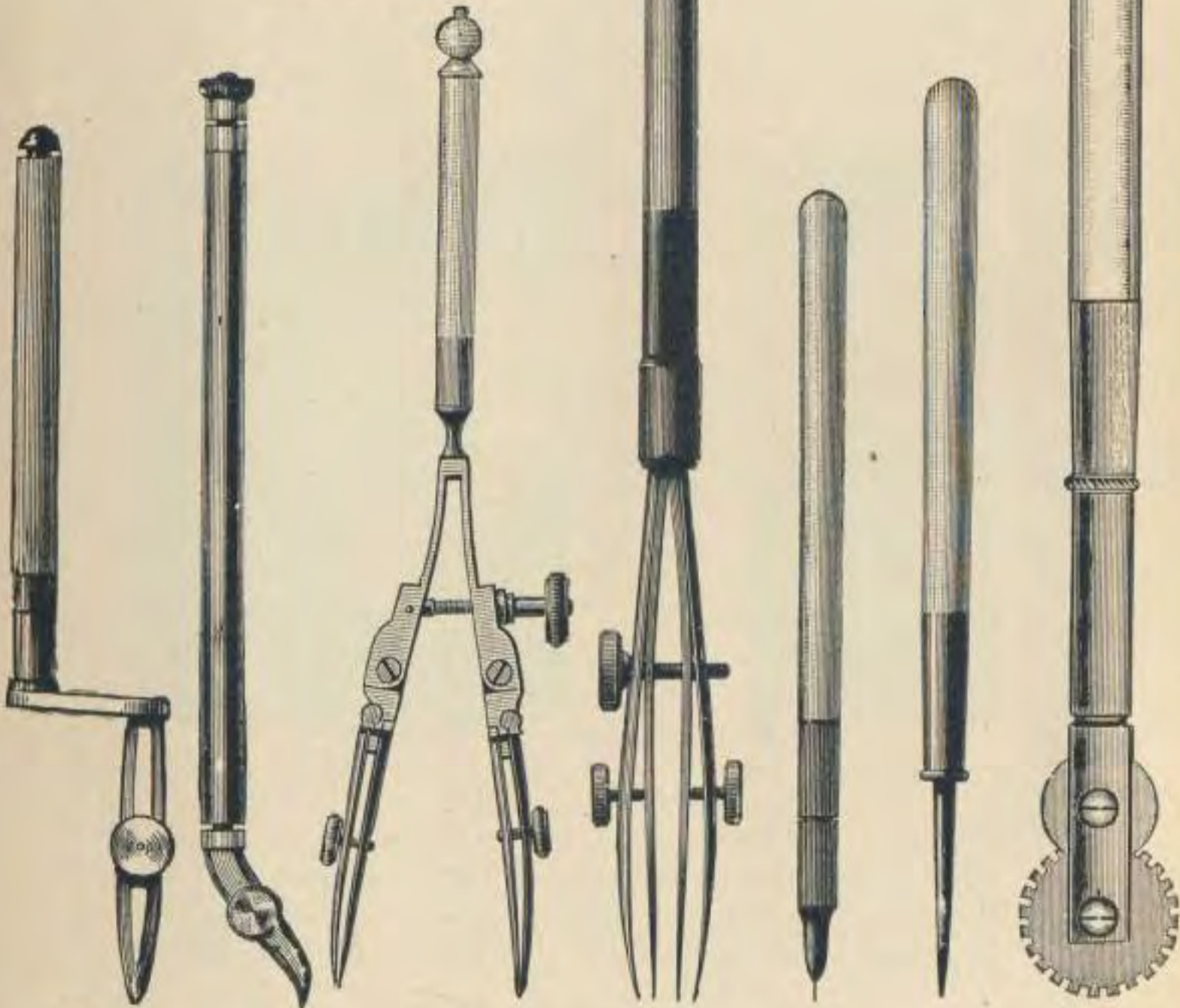

1304.

1305.

1307.

1308.

1310.

1312.

1314.

(For prices, see page 308.)

CASES OF FINE GERMAN SILVER INSTRUMENTS.

FOR ENGINEERS, ARCHITECTS, AND MACHINISTS.

No.		PRICE.	POST.
1330.	Morocco Case, containing: Compasses, No. 1245; Drawing-Pen, No. 1294; Box of Leads.....	\$3.25	\$0.12
1331.	Morocco Case, containing: Plain Dividers, No. 1235; Compasses, No. 1245; Drawing-Pen, No. 1294; Box of Leads	4.00	.13
1333.	Morocco Case, containing: Plain Dividers, No. 1237; Compasses, 5½-inch, with fixed needle point, pen and pencil points; Drawing-Pen, No. 1295; Box of Leads	3.50	.15
1335.	Morocco Case, containing: Plain Dividers, No. 1237; Compasses, No. 1247; Drawing-Pen, No. 1299; Box of Leads	5.00	.18



1330.



1337.

1337.	Morocco Case, containing: Spring Bow-compasses, 3½-inch, with long detachable handle, two pen points, pencil and needle points; Drawing-Pen, No. 1297; Box of Leads	5.00	.18
1339.	Morocco Case, containing: Plain Dividers, No. 1237; Compasses, No. 1247; Bow-pen, No. 1268; Drawing-Pen, No. 1299; Box of Leads.....	6.50	.18



1339.

No.		PRICE.	POST.
1340.	Morocco Case, containing : Plain Dividers, No. 1237 ; Compasses, Nos. 1245 and 1247 ; Drawing -Pens, Nos. 1297 and 1299 ; Box of Leads.....	\$8.75	\$0.20

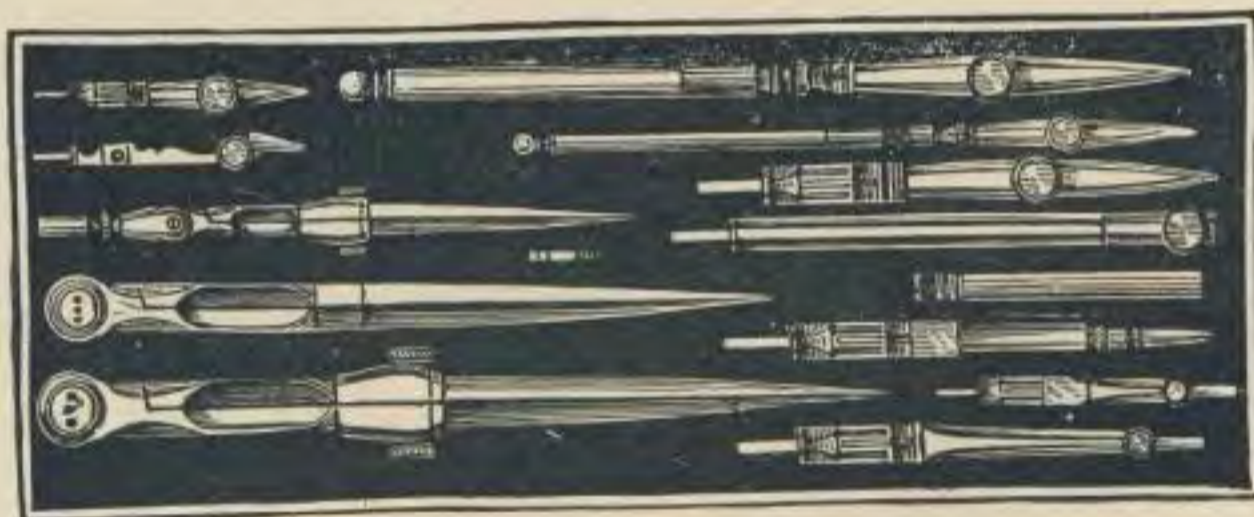

1340.

1341.	Morocco Case, containing : Plain Dividers, No. 1237 ; Compasses, Nos. 1245 and 1247 ; Bow-pen, No. 1268 ; Drawing -Pens, Nos. 1297 and 1299 ; Box of Leads.....	\$10.00	\$0.20
1342.	Morocco Case, containing : Plain Dividers, No. 1241 ; Compasses, No. 1247 ; Bow-spacer, No. 1267 ; Bow-pen, No. 1268 ; Bow-pencil, No. 1269 ; Drawing-Pens, Nos. 1297 and 1299 ; Box of Leads	10.00	.20
1344.	Polished Mahogany Box, with lock and tray, con- taining : Hairspring Dividers, No. 1241 ; Compasses, Nos. 1245 and 1247 ; Drawing-Pens, Nos. 1297 and 1299 ; Box of Leads.....	12.00	.40



1345.

No.		PRICE.	POST.
1345.	Polished Mahogany Box, with lock and tray, containing: Plain Dividers, No. 1237; Hairspring Dividers, No. 1241; Compasses, Nos. 1245 and 1247; Bow-pen, No. 1279; Drawing-Pens, Nos. 1297 and 1299; Box of Leads.....	\$14.50	\$0.45
1346.	Polished Mahogany Box, with lock and tray, containing: Hairspring Dividers, No. 1241; Compasses, Nos. 1245 and 1247; Proportional Dividers, No. 1253; Bow-pen, No. 1268; Drawing-Pens, Nos. 1297 and 1299; Box of Leads.....	16.00	.50
1348.	Polished Mahogany Box, with lock and tray, containing: Hairspring Dividers, No. 1241; Compasses, No. 1247; Proportional Dividers, No. 1253; Bow-spacer, No. 1267; Bow-pen, No. 1268; Bow-pencil, No. 1269; Railroad Pen, No. 1307; Curve-Pen, No. 1304; Drawing-Pens, Nos. 1297, 1299 and 1301; Box of Leads.....	20.00	.55
1352.	Polished Mahogany Box, with lock and tray, containing: Plain Dividers, No. 1237; Hairspring Dividers, No. 1241; Compasses, Nos. 1245 and 1247; Proportional Dividers, No. 1255; Bow-spacer, No. 1275; Bow-pen, No. 1276; Bow-pencil, No. 1277; Railroad Pen, No. 1308; Curve-Pen, No. 1305; Drawing-Pens, Nos. 1294, 1298 and 1301; Beam-Compass, No. 1259; Box of Leads..	35.00	.75

SETS OF PIVOT-JOINT INSTRUMENTS OF BEST GERMAN MAKE.

FINE GERMAN SILVER AND STEEL.

No.		PRICE.	POST.
1355.	Morocco Case, containing: Plain Dividers, 5-inch; Compasses, 5½-inch, with fixed needle point, pen and pencil points and lengthening bar; Drawing-Pen; Box of Leads...	\$9.00	\$0.15
1356.	Morocco Case, containing: Plain Dividers, 3½-inch; Compasses, 3½-inch, with fixed needle and pen points; Compasses, 3½-inch, with fixed needle and pencil points; Drawing-Pen; Box of Leads.....	10.00	.15



1358.

1358.	Morocco Case, containing: Hairspring Dividers, 5-inch; Compasses, 5½-inch, with fixed needle point, pen and pencil points and lengthening bar; Bow-spacer; Bow-pen; Bow-pencil; Two Drawing-Pens; Box of Leads	12.50	.20
1360.	Morocco Case, containing: Plain Dividers, 5-inch; Compasses, 5½-inch, with fixed needle point, pen and pencil points and lengthening bar; Compasses, 3½-inch, with fixed needle and pen points; Compasses, 3½-inch, with fixed needle and pencil points; Two Drawing-Pens; Box of Leads.....	15.00	.20

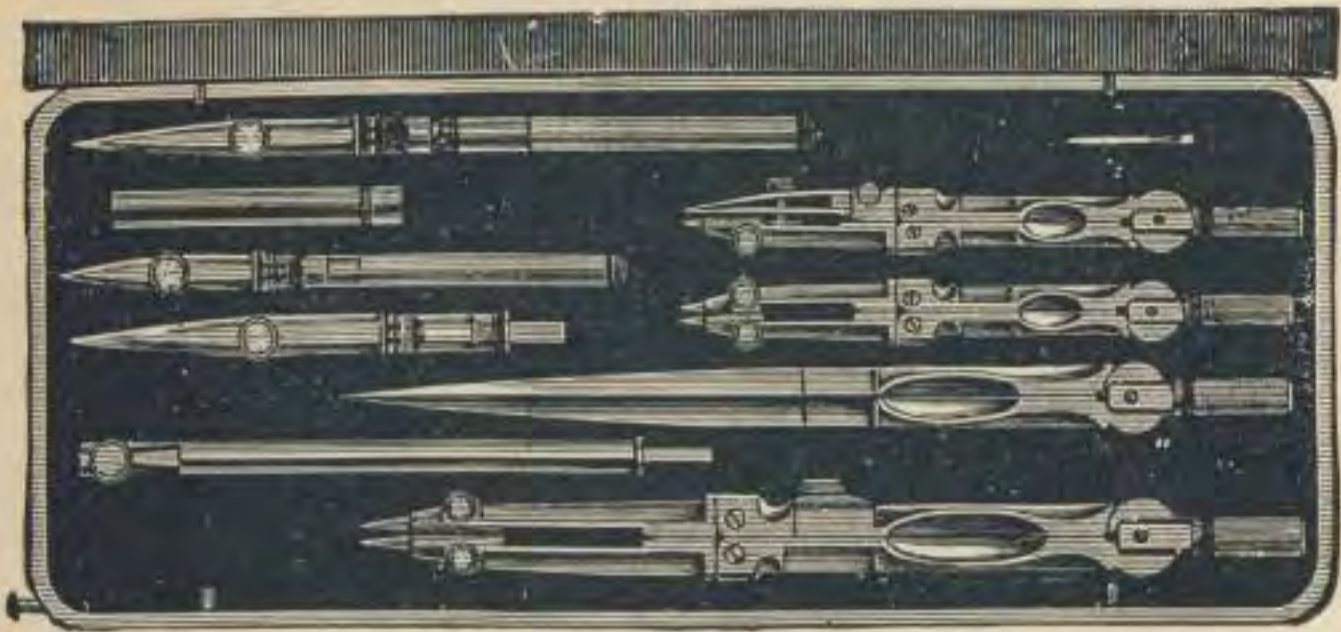

1360.

(For price, see page 313.)

SETS OF GERMAN SILVER DRAWING-INSTRUMENTS FOR SCHOOL USE.

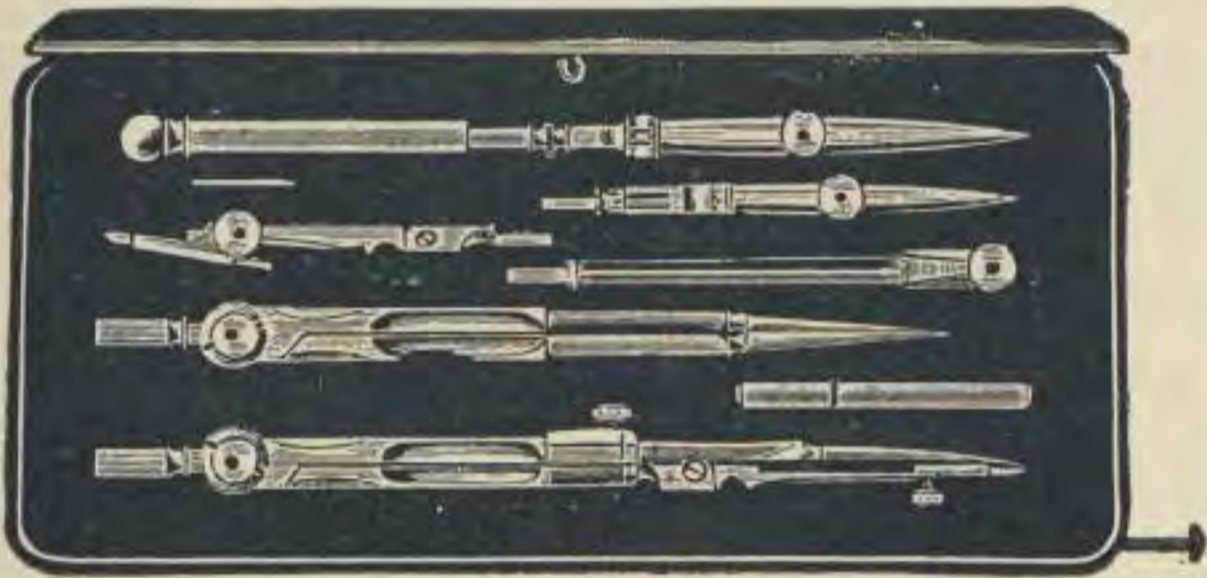

1365.

No.		PRICE.	POST.
1365.	Leather Case, containing: Plain Dividers, 5-inch; Compasses, 5½-inch, with fixed needle point, pen and pencil points and lengthening bar; Drawing-Pen; Box of Leads...	\$3.00	\$0.13
1367.	Leather Case, containing: Plain Dividers, 5-inch; Compasses, 5½-inch, with fixed needle point, pen and pencil points and lengthening bar; Bow-pen; Drawing-Pen; Box of Leads.....	4.00	.15
1369.	Leather Case, containing: Plain Dividers, 5-inch; Compasses, 5½-inch, with steel points, pen, pencil and needle points and lengthening bar; Bow-spacer; Bow-pen; Bow-pencil; Drawing-Pen; Box of Leads.....	6.00	.18

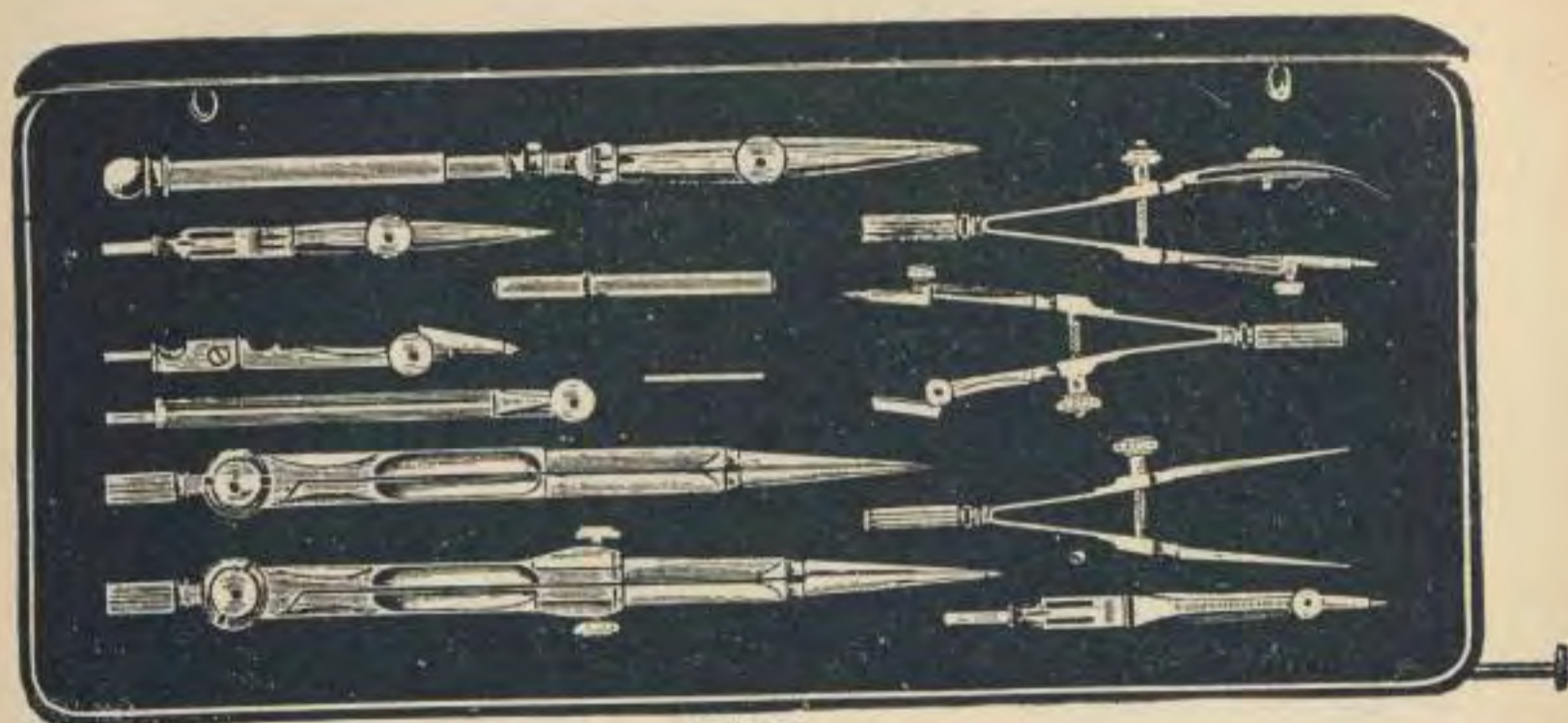

1369.

(For price, see page 314.)

No.		PRICE.	POST.
1371.	Leather Case containing: Plain Dividers, 5-inch; Compasses, 3½-inch, with steel points, pen, pencil and needle points; Compasses, 5½-inch, with steel points, pen, pencil and needle points and lengthening bar; Bow- spacer; Bow-pen; Bow-pencil; Two Drawing- Pens; Box of Leads.....	\$9.00	\$0.20

BRASS DRAWING-INSTRUMENTS.
FOR SCHOOL USE.

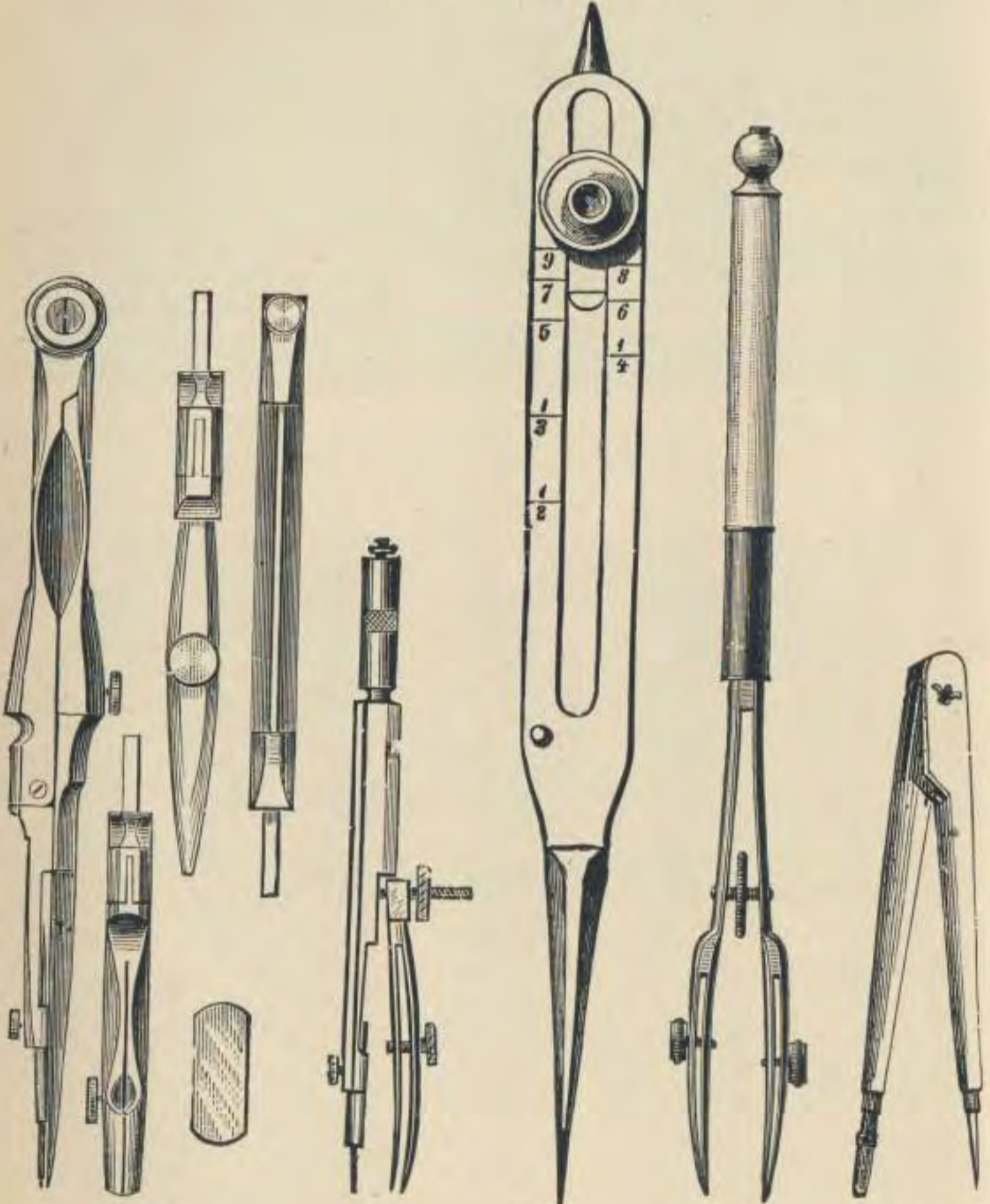

1386.

1389.

1393.

1397.

1400.

No.		PRICE.	POST.
1375.	Plain Dividers, rivet joint, 4-inch.....	\$0.15	\$0.02
1376.	Plain Dividers, rivet joint, 5-inch.....	.20	.03
1378.	Plain Dividers, screw joint, 4-inch.....	.20	.02
1379.	Plain Dividers, screw joint, 5-inch.....	.25	.03
1382.	Compasses, 3-inch, with pen point.....	.35	.03

No.		PRICE.	Post.
1383.	Compasses, 3-inch, with pencil point.....	\$0.35	\$0.03
1384.	Compasses, 3-inch, with pen, pencil and needle points40	.04
1385.	Compasses, 4½-inch, with pen and pencil points and lengthening bar.....	.50	.05
1386.	Compasses, 4½-inch, with fixed needle point, pen and pencil points, and lengthening bar.....	.60	.05
1387.	Compasses, 6-inch, with pen and pencil points, and lengthening bar.....	.65	.08
1388.	Compasses, 6-inch, with fixed needle point, pen and pencil points, and lengthening bar.....	.75	.08
1389.	Spring bow-pen, with needle point, 3-inch.....	.60	.02
1391.	Roulette, with three wheels, for dotting lines.....	.75	.03
1393.	Proportional Dividers, 6½-inch, divided for lines.....	1.50	.13
1395.	Drawing-Pen, wood handle.....	.15	.02
1396.	Drawing-Pen, bone handle.....	.20	.02
1397.	Railroad Drawing-Pen.....	1.50	.10
1400.	Wood Dividers, with crayon holder, 12-inch.....	1.00	.15
1401.	Wood Dividers, with crayon holder, 15-inch.....	1.25	.18
1402.	Wood Dividers, with crayon holder, 18-inch.....	1.50	.20

CASES OF BRASS DRAWING-INSTRUMENTS.

FOR SCHOOL USE.

1405.	Rosewood Box, containing : Plain Dividers, 4½-inch ; Compasses, 4-inch, with pen and pencil points ; Compasses, 6-inch, with pen and pencil points and lengthening bar ; Drawing-Pen ; Brass and Horn Protractors ; Wood Rule.....	\$2.00	\$0.23
1406.	Rosewood Box, with lock and tray, containing : Plain Dividers, 4½-inch ; Compasses, 4-inch, with fixed needle point, pen and pencil points ; Compasses, 6-inch, with fixed needle point, pen and pencil points and lengthening bar ; Drawing-Pen ; Brass and Horn Protractors ; Wood Rule.....	3.00	.28
1407.	Rosewood Box, etc., same as No. 1406, and with addition of Spring Bow-pen.....	3.75	.28
1408.	Rosewood Box, etc., same as No. 1406, and with addition of Spring Bow-pen, Proportional Dividers, Triangle and Irregular Curve, and omitting Brass Protractor.....	5.50	.35

NICKEL-PLATED DRAWING-INSTRUMENTS.



1413.

1416.

1418.

1420.



1425 AND 1427.

(For prices of Nos. 1413-1427, see page 319.)

NICKEL-PLATED BRASS DRAWING-INSTRUMENTS.

FOR SCHOOL USE. (See page 318.)

No.		PRICE.	POST.
1410.	Plain Dividers, rivet joint, 4½-inch.....	\$0.20	\$0.02
1411.	Plain Dividers, rivet joint, 5½-inch.....	.25	.03
1413.	Plain Dividers, screw joint, 4½-inch.....	.25	.02
1414.	Plain Dividers, screw joint, 5½-inch.....	.30	.03
1416.	Compasses, 4½-inch, with pencil point.....	.35	.03
1418.	Compasses, 4½-inch, with pen and pencil points....	.50	.04
1420.	Compasses, 4½-inch, with pen and pencil points and lengthening bar.....	.65	.05
1425.	Drawing-Pen, black wood handle, 5-inch.....	.20	.03
1427.	Drawing-Pen, bone handle, 5-inch.....	.30	.03

SETS OF NICKEL-PLATED DRAWING-INSTRUMENTS IN LEATHERETTE CASES.

FOR SCHOOL USE.

1430.	Case, containing: Compasses, 4½-inch, with pen and pencil points; Box of Leads; Color-Saucer.....	\$0.65	\$0.08
1431.	Case, containing: Compasses, 4½-inch, with pen and pencil points; Drawing-Pen; Box of Leads; Color-Saucer; Protractor, Ruler and Triangle.....	.85	.10



1433.

No.		PRICE.	POST.
1433.	Case, containing : Plain Dividers, 4-inch ; Compasses, 4½-inch, with pen and pencil points ; Drawing-Pen ; Box of Leads ; Color-Saucers ; Protractor, Ruler and Triangle.....	\$1.20	\$0.15

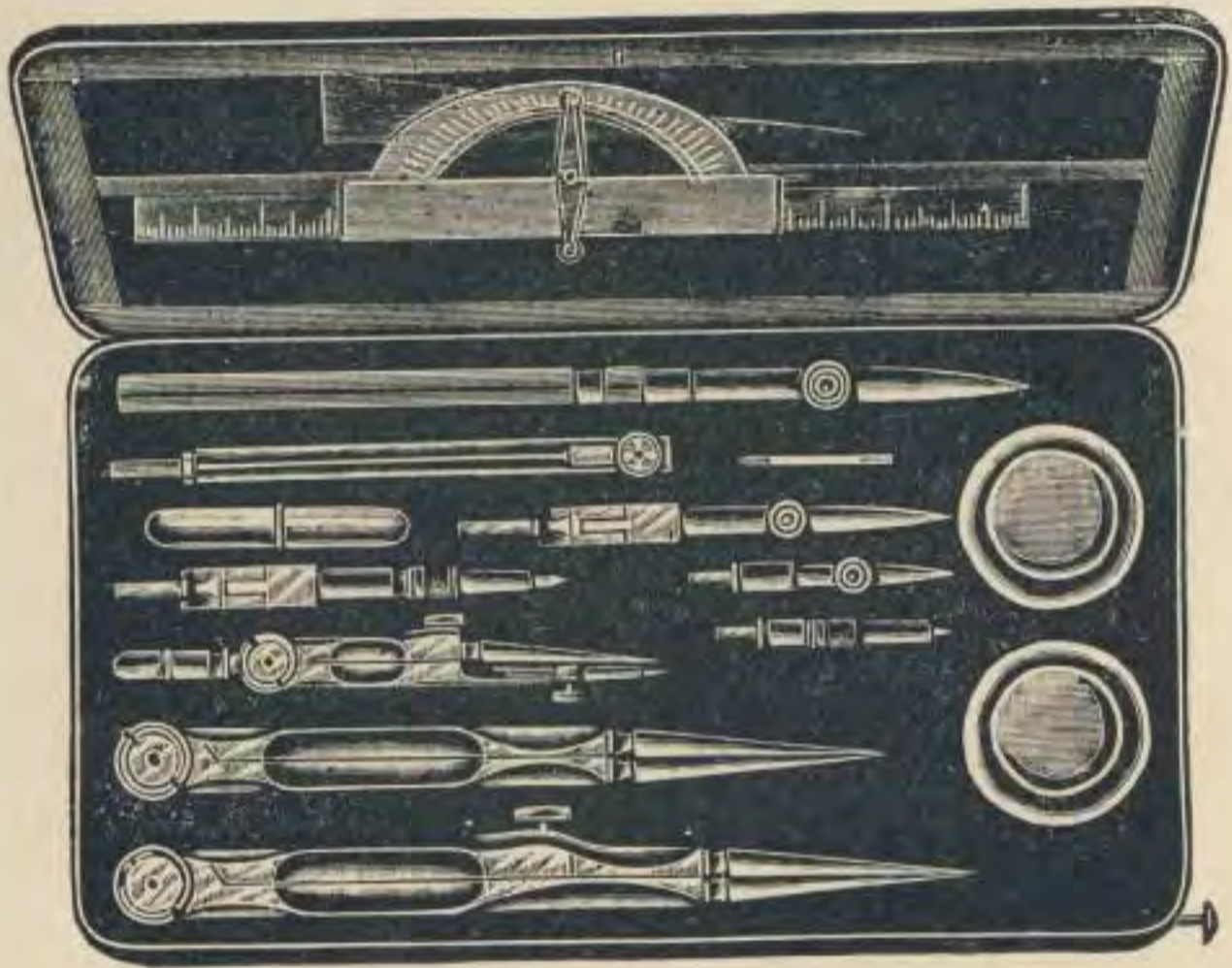

1435.

1435.	Case, containing : Plain Dividers, 4-inch ; Compasses, 3-inch, with pen, pencil and needle points ; Compasses, 4½-inch, with pen and pencil points and lengthen- ing bar ; Drawing-Pen ; Box of Leads ; Color- Saucers ; Protractor, Ruler and Triangle.....	1.80	.18
1436.	Case, containing : Plain Dividers, 4-inch ; Compasses, 4½-inch, with pen and pencil points and lengthening bar ; Spring Bow-pen ; Drawing-Pen ; Box of Leads ; Color-Saucers ; Protractor, Ruler and Triangle...	2.00	.20

PROTRACTORS.

EXTRA FINE SWISS GERMAN SILVER PROTRACTORS.

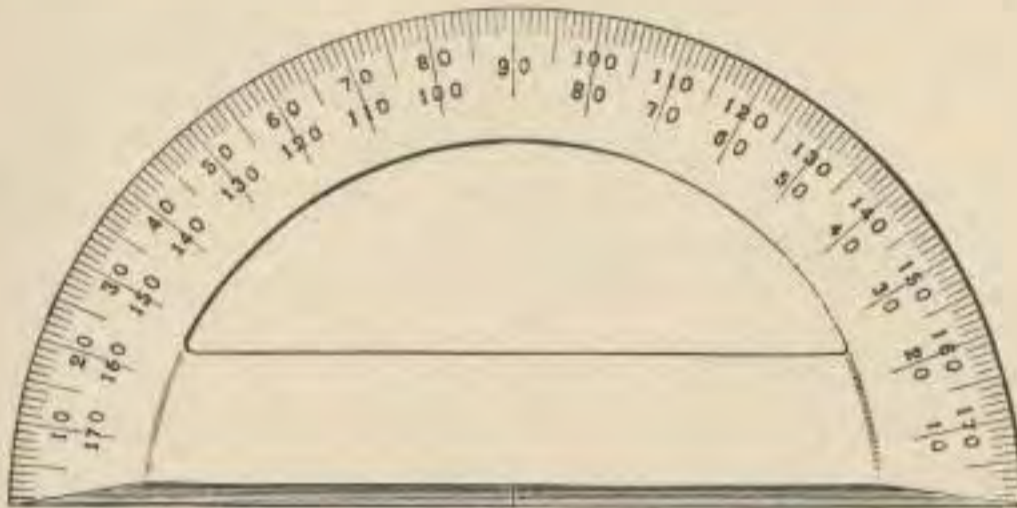

1442.

No.	DESCRIPTION	PRICE.	POST.
1440.	Protractor, half circle, 4-inch, beveled edge, center on outer edge, divided to 1 degree	\$1.50	\$0.12
1441.	Protractor, half circle, 5-inch, divided to $\frac{1}{2}$ degrees..	2.25	.13
1442.	Protractor, half circle, 6-inch, divided to $\frac{1}{2}$ degrees..	2.75	.15
1443.	Protractor, half circle, 6-inch, divided to $\frac{1}{4}$ degrees..	3.50	.15

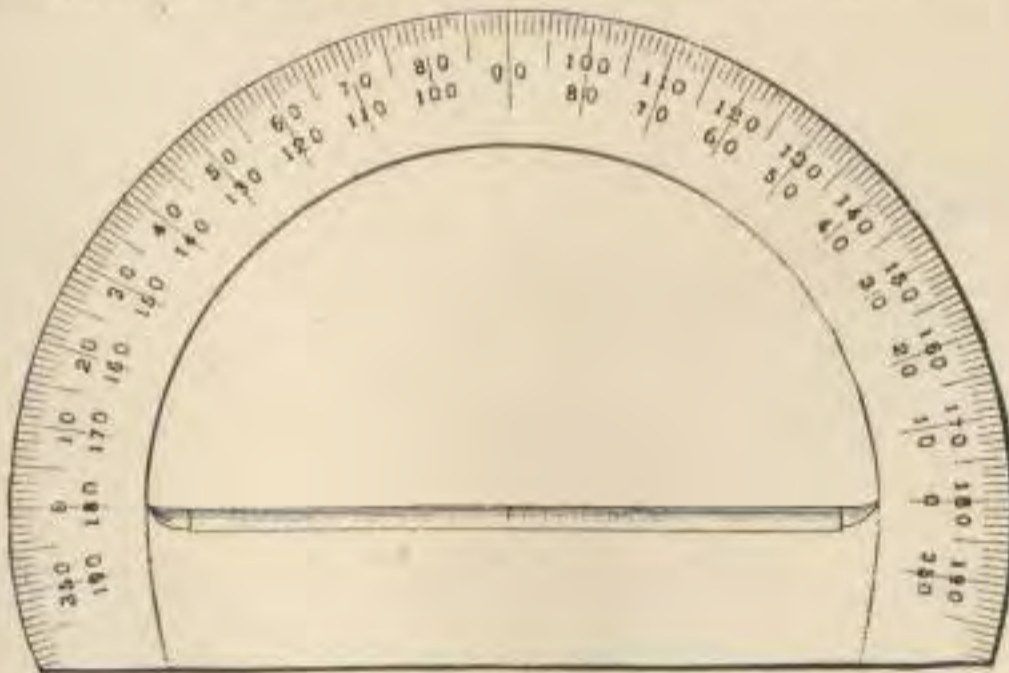

1446.

1445.	Protractor, half circle, 5-inch, beveled edge, center on inner edge, divided to $\frac{1}{2}$ degrees.....	2.75	.14
1446.	Protractor, half circle, 6-inch, divided to $\frac{1}{2}$ degrees..	3.50	.16
1447.	Protractor, half circle, 6-inch, divided to $\frac{1}{4}$ degrees..	4.25	.16
1450.	Protractor, whole circle, 5-inch, divided to $\frac{1}{2}$ degrees	5.00	.20

EXTRA FINE SWISS GERMAN SILVER PROTRACTORS, WITH ARM AND WITHOUT VERNIER.

No.	PRICE.	POST.
1454. Protractor, half circle, 6-inch, with horn center and 6-inch movable arm, divided to $\frac{1}{2}$ degrees.....	\$7.50	\$0.20
1455. Protractor, half circle, 7-inch, with horn center and 6-inch movable arm, divided to $\frac{1}{2}$ degrees.....	9.00	.25

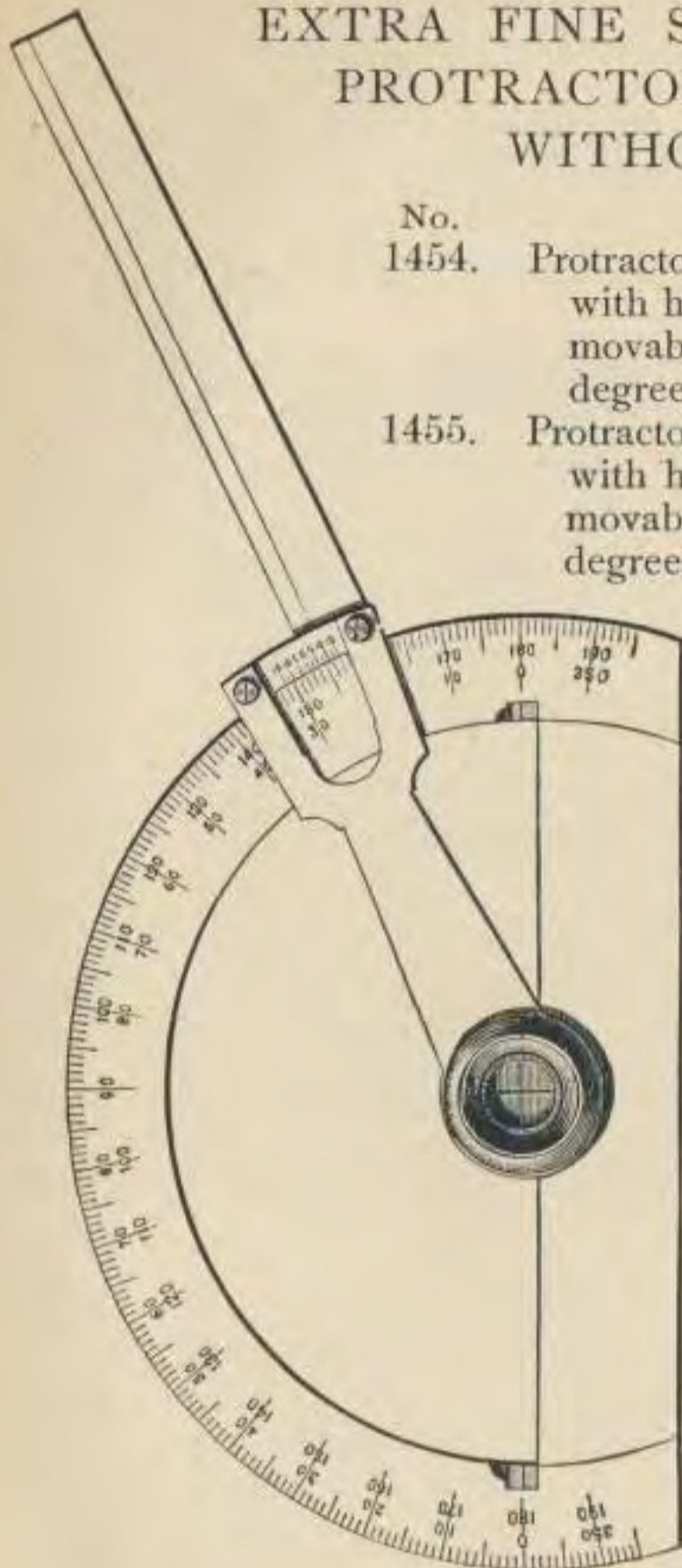

Length of arms extending over the outer edge of Protractors.

For Nos. 1460 and 1465, $5\frac{1}{2}$ -inch.
 For Nos. 1461, 1466, 1470, 6-inch.
 For Nos. 1462, 1467, 1473, $6\frac{1}{2}$ -inch.

1461.

EXTRA FINE SWISS GERMAN SILVER PROTRACTORS WITH ARM AND VERNIER.

No.	PRICE.	POST.
1460. Protractor, half circle, $5\frac{1}{2}$ -inch, with horn center and movable arm, divided to $\frac{1}{2}$ degrees, vernier reading to 3 minutes	\$10.00	\$0.20
1461. Protractor, half circle, 8-inch, divided to $\frac{1}{4}$ degrees, vernier to 1 minute.....	14.00	.25

No.		PRICE.	POST.
1462.	Protractor, half circle, 10-inch, divided to $\frac{1}{4}$ degrees, vernier to 1 minute.....	\$17.00	\$0.35
1465.	Protractor, whole circle, $5\frac{1}{2}$ -inch, with horn center and movable arm, divided to $\frac{1}{2}$ degrees, vernier reading to 3 minutes.....	14.00	.30
1466.	Protractor, whole circle, 8-inch, divided to $\frac{1}{4}$ degrees, vernier to 1 minute.....	16.00	.35
1467.	Protractor, whole circle, 10-inch, divided to $\frac{1}{4}$ degrees, vernier to 1 minute.....	20.00	.50
1470.	Protractor, half circle, 8-inch, with horn center and movable arm, divided to $\frac{1}{4}$ degrees, vernier to 1 minute, with clamp and tangent to arm.....	18.00	.30
1473.	Protractor, whole circle, 8-inch, with horn center and movable arm, divided to $\frac{1}{4}$ degrees, vernier to 1 minute, with clamp and tangent to arm.....	20.00	.40

MAHOGANY CASES FOR PROTRACTORS.

1476.	Case for Protractors Nos. 1454, 1455, 1460	\$1.75	\$0.25
1477.	Case for Protractors Nos. 1461, 1462, 1465, 1470...	2.25	.35
1478.	Case for Protractors Nos. 1466, 1467, 1473	3.00	.45

LIMB - PROTRACTOR.

BRONZE HEAD, STEEL BLADE, VERNIER TO ONE MINUTE.

Made by W. & L. E. Gurley.

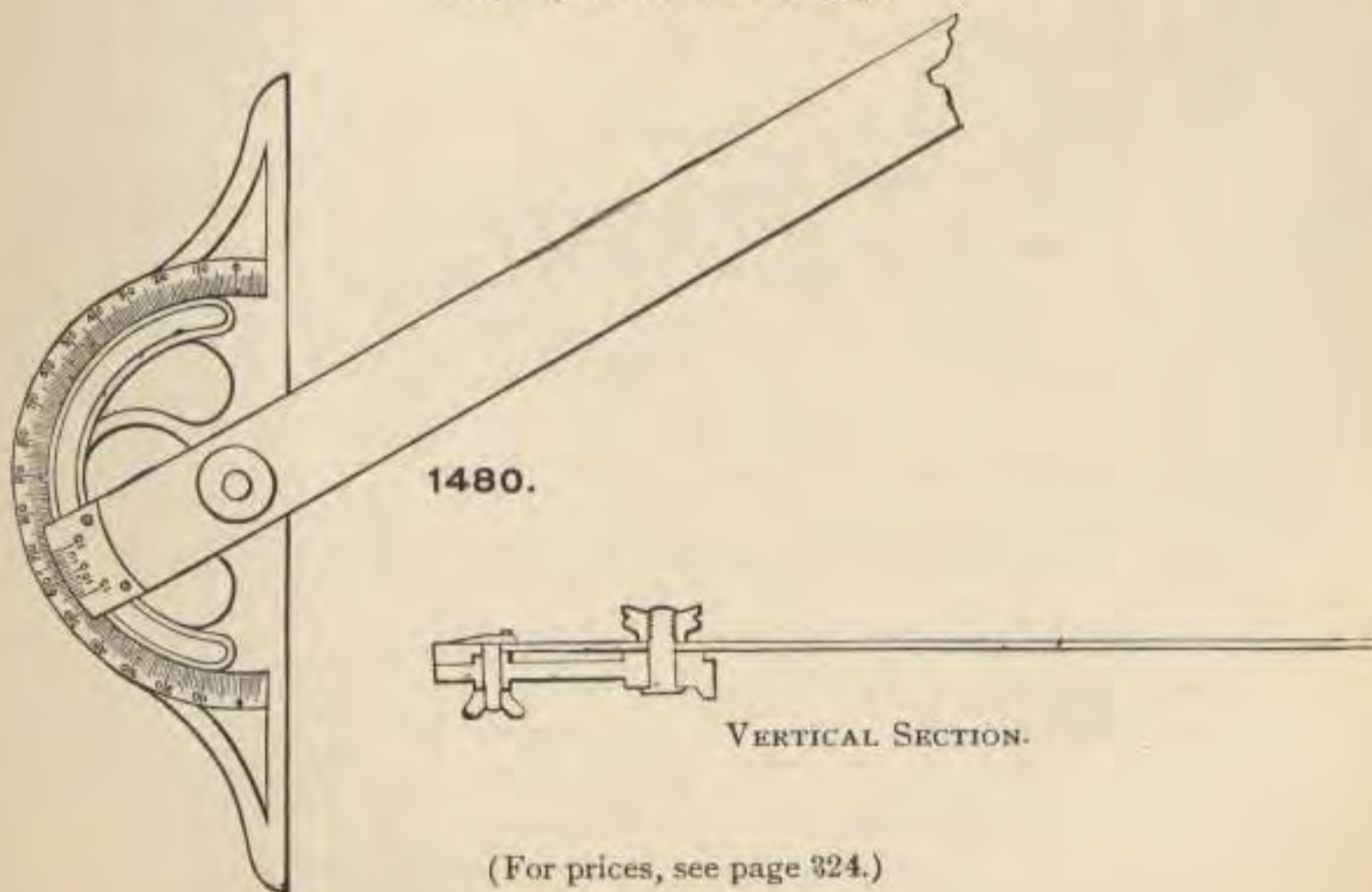

(For prices, see page 324.)

No.			PRICE.	POST.
1480.	Limb-Protractor, with blade 24-inch.	Nickel-plated	\$8.00	\$0.65
1481.	Limb-Protractor, with blade 30-inch.	Nickel-plated	8.75	.70
1482.	Limb-Protractor, with blade 36-inch.	Nickel-plated	9.50	.75
1483.	Limb-Protractor, with blade 42-inch.	Nickel-plated	10.25	.85
1484.	Limb-Protractor, with blade 48-inch.	Nickel-plated	11.50	1.00

CROZET'S PROTRACTOR.

(Made by W. & L. E. Gurley.)

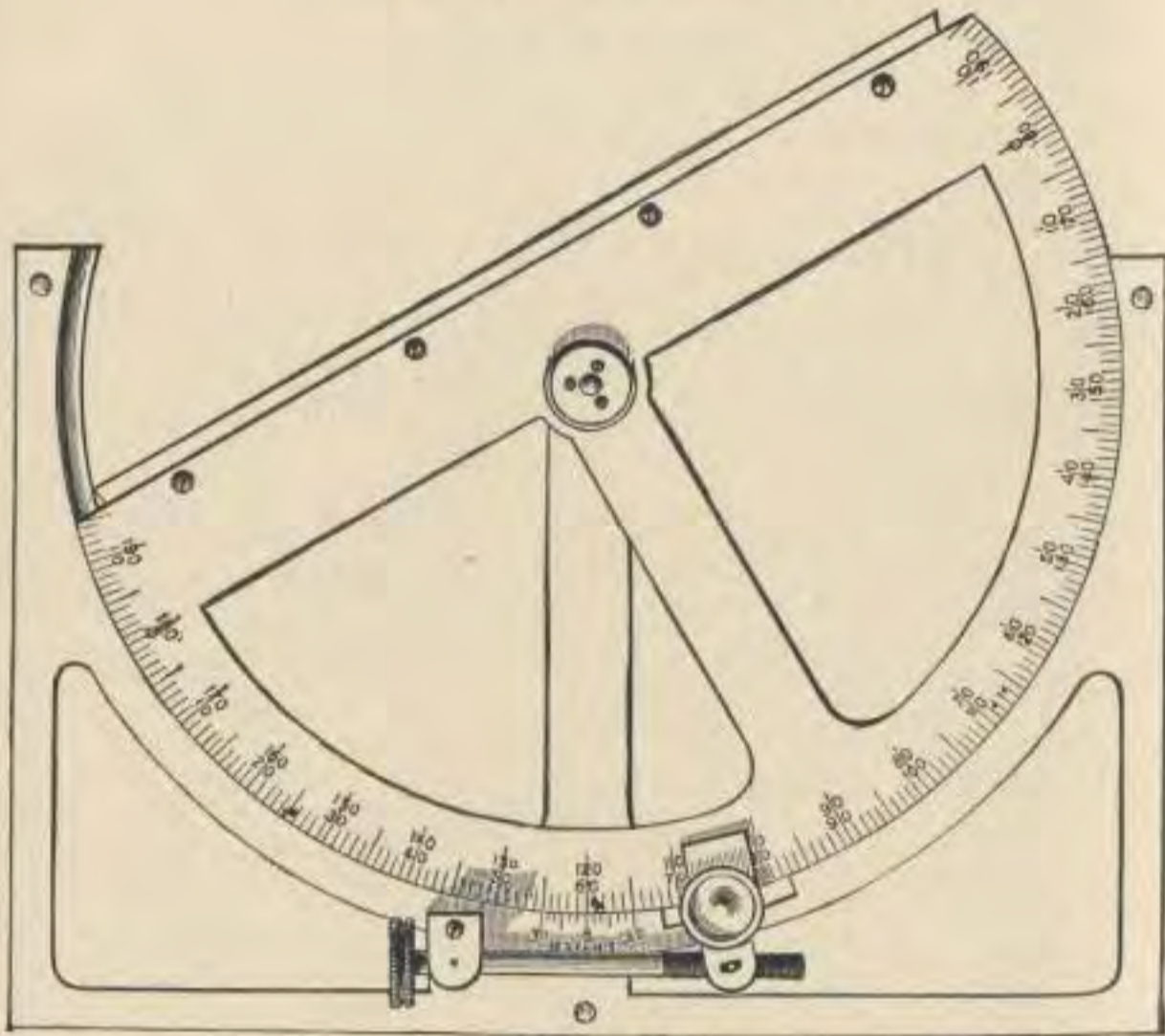

1488.

1488. German Silver Protractor, 8-inch, half circle, half degrees, with vernier to 1 minute. In mahogany case \$40.00 \$0.70

The Crozet Protractor, named from its inventor, an officer of the U. S. Engineer Corps, we recommend as the best among the various high grade protractors yet devised.

It may be used with the T-rule or straight-edge. The feather-edge is always set to the starting-point and the line produced without puncturing the paper.

DUFFIELD'S PATENT PROTRACTOR.

(Made by W. & L. E. Gurley.)

Made of transparent celluloid, and with two parallel scales of twenty parts to the inch, to enable the zero line to be set parallel to meridian lines drawn on the paper.

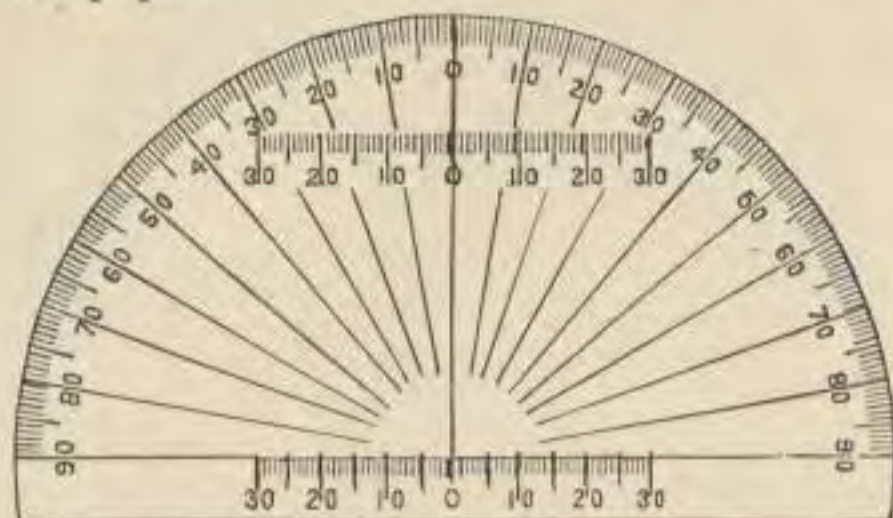

1490.

No.		PRICE.	Post.
1490.	Protractor, half circle, 6-inch, divided to $\frac{1}{2}$ degrees..	\$3.00	\$0.12
1492.	Protractor, half circle, 9-inch, divided to $\frac{1}{2}$ degrees..	3.50	.15
1494.	Protractor, half circle, 12-inch, divided to $\frac{1}{4}$ degrees	4.00	.20

GERMAN SILVER PROTRACTORS.

1500.	German Silver Protractor, 4-inch, half circle, whole degrees.....	\$0.50	\$0.03
1502.	German Silver Protractor, 5-inch, half circle, half degrees.....	.85	.05
1503.	German Silver Protractor, 6-inch, half circle, half degrees.....	1.00	.07



1510.

1509.	German Silver Protractor, 5-inch, half circle, beveled edge, half degrees.....	1.00	.13
1510.	German Silver Protractor, 6-inch, half circle, beveled edge, half degrees	1.50	.15
1511.	German Silver, Protractor, 7-inch, half circle, beveled edge, half degrees	2.00	.18

BRASS PROTRACTORS.

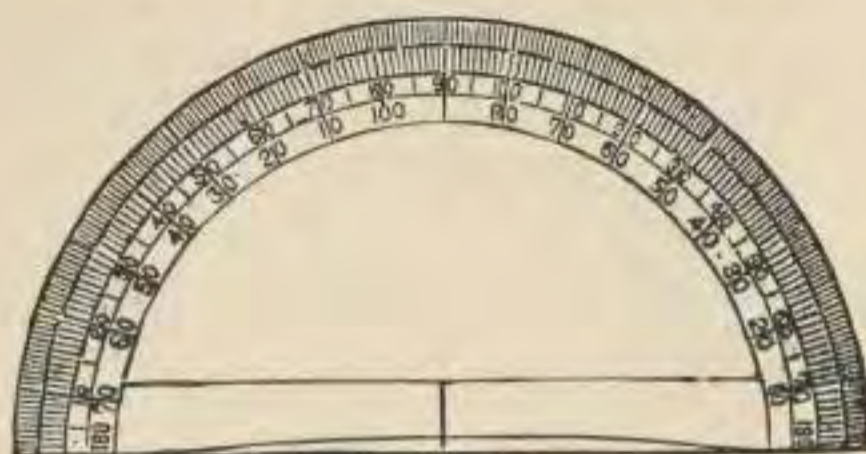

1518.

No.		PRICE.	POST.
1515.	Brass Protractor, 3-inch, half circle, whole degrees.	\$0.10	\$0.02
1516.	Brass Protractor, 4-inch, half circle, whole degrees.	.20	.03
1517.	Brass Protractor, 4-inch, half circle, half degrees35	.03
1518.	Brass Protractor, 5-inch, half circle, half degrees50	.05
1519.	Brass Protractor, 6-inch, half circle, half degrees60	.07

HARD RUBBER PROTRACTORS.

1525.	Rubber Protractor, 6-inch, half circle, half degrees.	\$3.00	\$0.13
1526.	Rubber Protractor, 8-inch, half circle, half degrees.	3.75	.15
1528.	Rubber Protractor, 6-inch, whole circle, half degrees.....	3.75	.18

CELLULOID PROTRACTORS.

1532.	Celluloid Protractor, 6-inch, half circle, beveled edge, half degrees.....	\$3.00	\$0.13
1533.	Celluloid Protractor, 8-inch, half circle, beveled edge, half degrees	3.75	.15
1535.	Celluloid Protractor, 6-inch, whole circle, beveled edge, half degrees	3.75	.18

TRANSPARENT HORN PROTRACTORS.

1540.	Horn Protractor, 4-inch, half circle, whole degrees.	\$0.12	\$0.02
1541.	Horn Protractor, 5-inch, half circle, half degrees20	.02
1542.	Horn Protractor, 6-inch, half circle, half degrees25	.03
1544.	Horn Protractor, 8-inch, half circle, half degrees50	.05
1547.	Horn Protractor, 5-inch, whole circle, half degrees.	1.25	.12
1548.	Horn Protractor, 6-inch, whole circle, half degrees.	1.50	.14

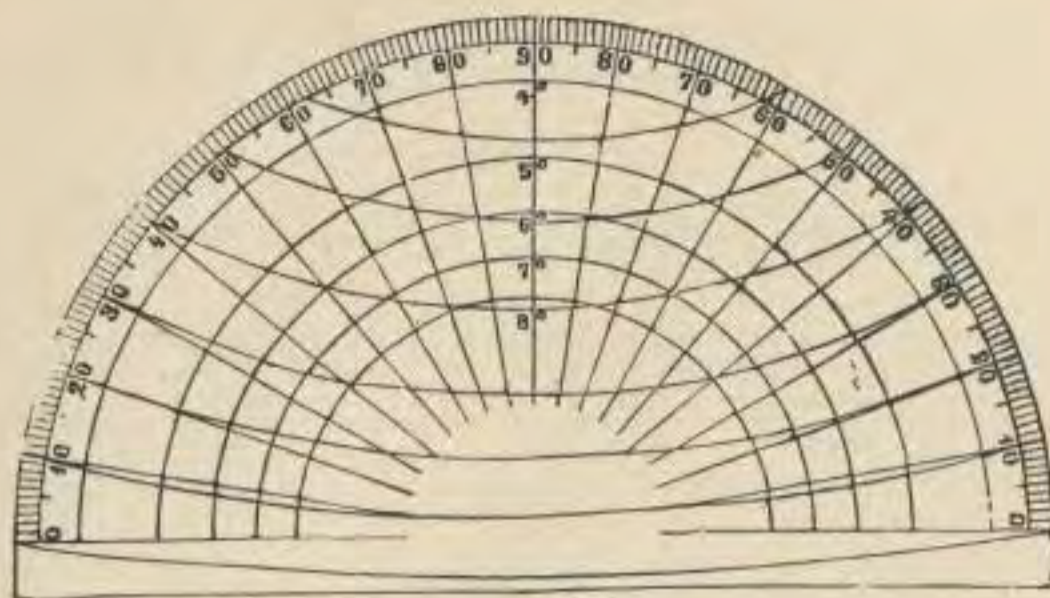

1550.

No.		PRICE.	POST.
1550.	Railroad Curve-Protractor, of horn, 8-inch, half circle, half degrees, having laid off on it twenty-three curves from $\frac{1}{2}$ degree to 8 degrees, to a scale of 400 feet to the inch.....	\$1.60	\$0.13

PAPER PROTRACTORS.

1552.	Protractor, on Bristol-Board, 5-inch, half circle, half degrees.....	\$0.10	\$0.02
1553.	Protractor, on Bristol-Board, 6-inch, half circle, half degrees.....	.15	.02
1554.	Protractor, on Bristol-Board, 5-inch, half circle, half degrees, and diagonal scales to inches and $\frac{1}{100}$ th, and millimeter.....	.15	.02
1555.	Protractor, on Bristol-Board, 8-inch, whole circle, half degrees.....	.20	.04
1556.	Protractor, on Bristol-Board, 13-inch, whole circle, quarter degrees.....	.40	.07
1558.	Protractor, on Drawing-Paper, 13-inch, whole circle, quarter degrees.....	.30	.06
1559.	Protractor, on Tracing-Paper, 13-inch, whole circle, quarter degrees.....	.25	.06

SCALES.

IVORY PROTRACTOR-SCALES.



1560. FRONT SIDE.

No.		PRICE.	POST.
1560.	Ivory Rectangular Protractor, 6 inches long, $1\frac{3}{4}$ inches wide, with scales as follows: front sides divided around edges from 0 to 180 degrees in single degrees, scales of $\frac{1}{4}$, $\frac{1}{2}$, $\frac{3}{4}$ and 1 inch to the foot, and scale of chords. Reverse side scales of 30, 35, 40, 45, 50 and 60 parts to the inch, scale of chords and diagonal scale of inches and $\frac{1}{100}$ ths.	\$1.50	\$0.12
1561.	Ivory Rectangular Protractor, 6 inches long by $1\frac{3}{4}$ inches wide, with scales as follows: front side, the edge divided into single degrees from 0 to 180 degrees, scales of $\frac{1}{8}$, $\frac{1}{4}$, $\frac{3}{8}$, $\frac{1}{2}$, $\frac{5}{8}$, $\frac{3}{4}$, $\frac{7}{8}$, and 1 inch to the foot, and scale of chords. On the reverse side, scales of 30, 35, 40, 45, 50 and 60 parts to the inch, scale of chords and diagonal scale of $\frac{1}{100}$ ths	2.00	.12
1563.	Ivory Rectangular Protractor, 6 inches long by 2 inches wide, with scales as follows: front side the edge divided in $\frac{1}{2}$ degrees from 0 to 180 degrees, scales of $\frac{1}{8}$, $\frac{1}{4}$, $\frac{3}{8}$, $\frac{1}{2}$, $\frac{5}{8}$, $\frac{3}{4}$, $\frac{7}{8}$, 1, $1\frac{1}{8}$, $1\frac{1}{4}$ inches to the foot, scale of chords, and line of 40 parts on lower edge. On the reverse side, scales of 20, 25, 30, 35, 40, 45, 50 and 60 parts to the inch, and diagonal scale of $\frac{1}{100}$ ths.....	4.00	.13
1564.	Ivory Rectangular Protractor, 6 inches long by $2\frac{1}{4}$ inches wide, with scales as follows: front side, the edge divided in $\frac{1}{2}$ degrees from 0 to 180 degrees, scales of $\frac{1}{8}$, $\frac{1}{4}$, $\frac{3}{8}$, $\frac{1}{2}$, $\frac{5}{8}$, $\frac{3}{4}$, $\frac{7}{8}$, 1, $1\frac{1}{8}$, $1\frac{1}{4}$, $1\frac{3}{8}$, $1\frac{1}{2}$ inches to the foot, scale of chords, and scale of 40 parts on the lower edge. Reverse side, scales of 10, 15, 20, 25, 30, 35, 40, 45, 50 and 60 parts to the inch, and diagonal scale of $\frac{1}{100}$ ths	4.50	.13

FLAT BOXWOOD AND IVORY SCALES.

No.		PRICE.	POST.
1570.	Boxwood Protractor, 6 inches long, $1\frac{3}{4}$ inches wide, divided to whole degrees, with scales $\frac{1}{4}$, $\frac{1}{2}$, $\frac{3}{4}$, 1 inch, diagonal scale and scale of chords.....	\$0.35	\$0.03
1572.	Boxwood Scale, 6-inch, for school use.....	.15	.02

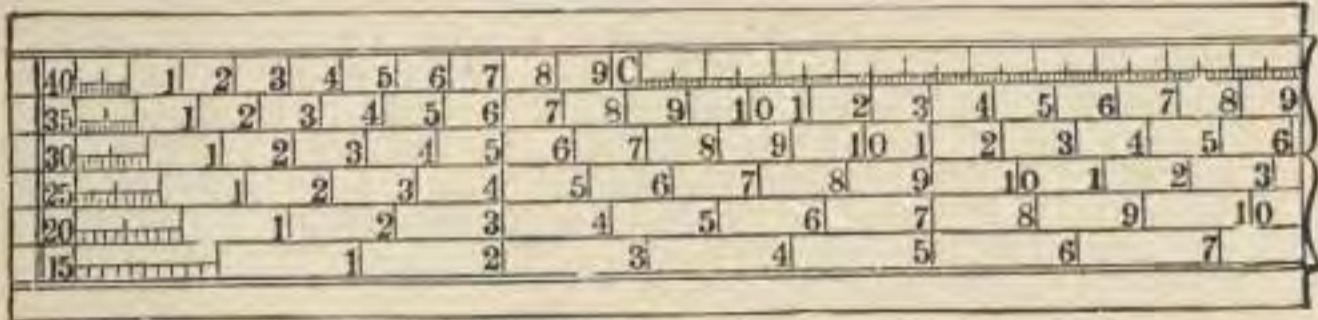

1573.

1573.	Ivory Scale, 6-inch, with diagonal and chain-scales	.75	.03
1575.	Boxwood Sector-Scale, 6-inch, opens to 12-inch	1.00	.12
1576.	Ivory Sector-Scale, 6-inch, opens to 12-inch	2.25	.15
1577.	Boxwood Scale, 6-inch, divided $\frac{1}{8}$, $\frac{1}{4}$, $\frac{1}{2}$, 1 inch to the foot50	.03



1578.

1578.	Boxwood Scale, 12-inch, divided $\frac{1}{8}$, $\frac{1}{4}$, $\frac{1}{2}$, 1 inch to the foot75	.06
1579.	Boxwood Scale, 18-inch, divided $\frac{1}{8}$, $\frac{1}{4}$, $\frac{1}{2}$, 1 inch to the foot	1.50	.18
1580.	Boxwood Scale, 24-inch, divided $\frac{1}{8}$, $\frac{1}{4}$, $\frac{1}{2}$, 1 inch to the foot	2.00	.22
1581.	Ivory Scale, 6-inch, divided $\frac{1}{8}$, $\frac{1}{4}$, $\frac{1}{2}$, 1 inch to the foot.....	2.00	.12
1582.	Ivory Scale, 12-inch, divided $\frac{1}{8}$, $\frac{1}{4}$, $\frac{1}{2}$, 1 inch to the foot.....	3.00	.14
1583.	Boxwood Scale, 6-inch, divided $\frac{3}{8}$, $\frac{3}{4}$, $1\frac{1}{2}$, 3 inches to the foot50	.03

No.		PRICE.	POST.
1584.	Boxwood Scale, 12-inch, divided $\frac{3}{8}$, $\frac{3}{4}$, $1\frac{1}{2}$, 3 inches to the foot.....	\$0.75	\$0.06
1585.	Boxwood Scale, 18-inch, divided $\frac{3}{8}$, $\frac{3}{4}$, $1\frac{1}{2}$, 3 inches to the foot.....	1.50	.18
1586.	Boxwood Scale, 24-inch, divided $\frac{3}{8}$, $\frac{3}{4}$, $1\frac{1}{2}$, 3 inches to the foot.....	2.00	.22
1587.	Ivory Scale, 6-inch, divided $\frac{3}{8}$, $\frac{3}{4}$, $1\frac{1}{2}$, 3 inches to the foot.....	2.00	.12
1588.	Ivory Scale, 12-inch, divided $\frac{3}{8}$, $\frac{3}{4}$, $1\frac{1}{2}$, 3 inches to the foot.....	3.00	.14
1590.	Boxwood White-Edge Scale, 6-inch, divided $\frac{1}{8}$, $\frac{1}{4}$, $\frac{1}{2}$, 1 inch to the foot.....	.75	.03
1591.	Boxwood White-Edge Scale, 12-inch, divided $\frac{1}{8}$, $\frac{1}{4}$, $\frac{1}{2}$, 1 inch to the foot.....	1.25	.14
1594.	Boxwood White-Edge Scale, 6-inch, divided $\frac{3}{8}$, $\frac{3}{4}$, $1\frac{1}{2}$, 3 inches to the foot.....	.75	.03
1595.	Boxwood White-Edge Scale, 12-inch, divided $\frac{3}{8}$, $\frac{3}{4}$, $1\frac{1}{2}$, 3 inches to the foot.....	1.25	.14
1600.	Boxwood Scale, 12-inch, with 12 scales, as follows: $\frac{1}{8}$, $\frac{3}{16}$, $\frac{1}{4}$, $\frac{3}{8}$, $\frac{5}{8}$, $\frac{7}{8}$, 1, $1\frac{1}{4}$, $1\frac{1}{2}$, $1\frac{3}{4}$, 2 and 3 inches to the foot, the first division of each scale subdivided into 12 parts, and diagonal scale reading to $\frac{1}{100}$ and $\frac{1}{200}$ of an inch.....	.90	.06
1601.	Ivory Scale, 12-inch, divided same as No. 1600.....	3.00	.14
1604.	Boxwood Scale, 12-inch, one side rounded, the other flat, with the following scales, the graduations of which are all brought to the edge: $\frac{1}{16}$, $\frac{1}{8}$, $\frac{3}{16}$, $\frac{1}{4}$, $\frac{3}{8}$, $\frac{1}{2}$, $\frac{5}{8}$, $\frac{3}{4}$, $\frac{7}{8}$, 1, $1\frac{1}{4}$, $1\frac{1}{2}$, $1\frac{3}{4}$, 2, $2\frac{1}{2}$ and 3 inches to the foot, the first division of each scale subdivided into 12 parts.....	.90	.06
1605.	Ivory Scale, 12-inch, divided same as No. 1604.....	3.00	.14
1608.	Boxwood Scale, 12-inch, with diagonal and Gunter scales.....	.75	.06
1609.	Boxwood Scale, 24-inch, with diagonal and Gunter scales.....	1.00	.20
1610.	Boxwood School Rule, 12-inch, divided $\frac{1}{16}$ and $\frac{1}{8}$ of an inch.....	.10	.03
1611.	Boxwood School Rule, 18-inch, divided $\frac{1}{8}$ of an inch, and with inlaid brass edges.....	.35	.10

FLAT BOXWOOD CHAIN-SCALES.



1618.

No.		PRICE.	POST.
1615.	Boxwood Scale, 6-inch, divided 10 and 50 parts to the inch.....	\$0.50	\$0.03
1616.	Boxwood Scale, 6-inch, divided 20 and 40 parts to the inch.....	.50	.03
1617.	Boxwood Scale, 6-inch, divided 30 and 60 parts to the inch.....	.50	.03
1618.	Boxwood Scale, 12-inch, divided 10 and 50 parts to the inch.....	.75	.06
1619.	Boxwood Scale, 12-inch, divided 20 and 40 parts to the inch.....	.75	.06
1620.	Boxwood Scale, 12-inch, divided 30 and 60 parts to the inch.....	.75	.06
1627.	Boxwood Off-set Scales, 2-inch, divided like Nos. 1615 to 1617, each.....	.40	.02
1632.	Boxwood White-Edge Scale, 12-inch, divided 10 and 50 parts to the inch.....	1.25	.14
1633.	Boxwood White-Edge Scale, 12-inch, divided 20 and 40 parts to the inch.....	1.25	.14
1634.	Boxwood White-Edge Scale, 12-inch, divided 30 and 60 parts to the inch.....	1.25	.14
1641.	White-Edge Off-set Scales, 2-inch, divided like Nos. 1632 to 1634, each.....	.70	.02

FLAT METALLIC CHAIN-SCALES.

(A superior article, our own make, made of brass, and nickel-plated. Divided on beveled edges.)

1645.	Flat Metal Scale, 12-inch, divided 10 and 50 parts to the inch.....	\$3.00	\$0.18
1646.	Flat Metal Scale, 12-inch, divided 20 and 40 parts to the inch.....	3.00	.18
1647.	Flat Metal Scale, 12-inch, divided 30 and 60 parts to the inch.....	3.75	.18
1648.	Flat Metal Scale, 12-inch, divided 80 and 100 parts to the inch.....	5.00	.18

No.		PRICE.	POST.
1649.	Flat Metal Scale, 12-inch, divided 100 and 500 parts to the foot	\$3.00	\$0.18
1650.	Flat Metal Scale, 30 centimeters, divided to millimeters and half millimeters	3.75	.18

TRIANGULAR BOXWOOD SCALES.

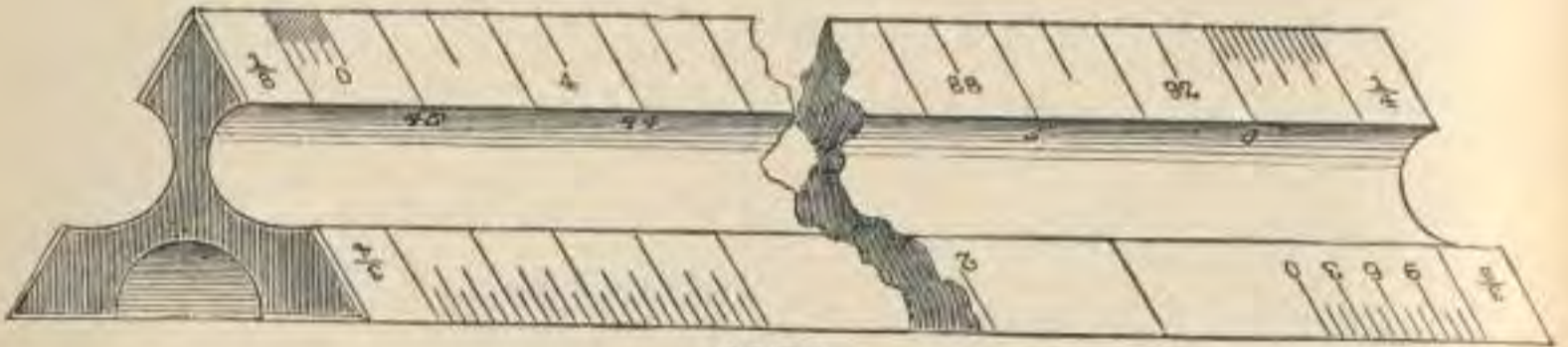

1656.

1655.	Triangular Boxwood Scale, 6-inch, divided $\frac{1}{8}$, $\frac{1}{4}$, $\frac{3}{8}$, $\frac{1}{2}$, $\frac{3}{4}$, 1, $1\frac{1}{2}$, 2, 3 and 4 inches to the foot, and one edge inches and 16ths.....	\$0.75	\$0.04
1656.	Triangular Boxwood Scale, 12-inch, divided $\frac{1}{8}$, $\frac{1}{4}$, $\frac{3}{8}$, $\frac{1}{2}$, $\frac{3}{4}$, 1, $1\frac{1}{2}$, 2, 3 and 4 inches to the foot, and one edge inches and 16ths.....	1.00	.14
1657.	Triangular Boxwood Scale, 18-inch, divided $\frac{1}{8}$, $\frac{1}{4}$, $\frac{3}{8}$, $\frac{1}{2}$, $\frac{3}{4}$, 1, $1\frac{1}{2}$, 2, 3 and 4 inches to the foot, and one edge inches and 16ths.....	2.50	.20
1658.	Triangular Boxwood Scale, 24-inch, divided $\frac{1}{8}$, $\frac{1}{4}$, $\frac{3}{8}$, $\frac{1}{2}$, $\frac{3}{4}$, 1, $1\frac{1}{2}$, 2, 3 and 4 inches to the foot, and one edge inches and 16ths.....	4.25	.25

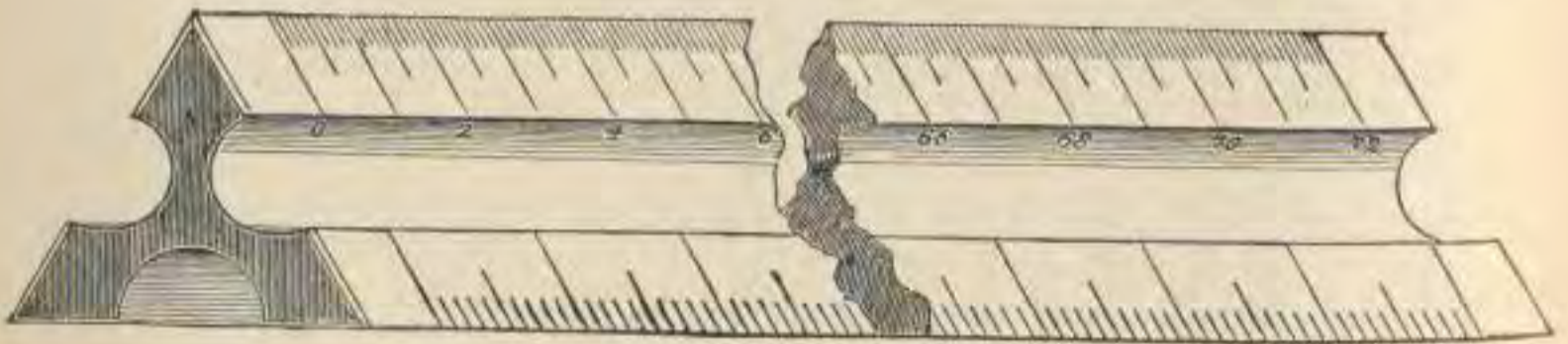

1661.

1660.	Triangular Boxwood Scale, 6-inch, divided 10, 20, 30, 40, 50 and 60 parts to the inch.....	.75	.04
1661.	Triangular Boxwood Scale, 12-inch, divided 10, 20, 30, 40, 50 and 60 parts to the inch	1.00	.14
1662.	Triangular Boxwood Scale, 18-inch, divided 10, 20, 30, 40, 50 and 60 parts to the inch.....	2.50	.20
1663.	Triangular Boxwood Scale, 24-inch, divided 10, 20, 30, 40, 50 and 60 parts to the inch.....	4.25	.25

No.		PRICE.	POST.
1665.	Triangular Boxwood Scale, 12-inch, divided 20, 30, 40, 50, 60 and 80 parts to the inch.....	\$1.00	\$0.14
1668.	Triangular Off-set Scale, 2-inch, divided same as No. 1660.....	.60	.02
1670.	Triangular Boxwood Scale, 12-inch, divided 100, 200, 300, 400, 500 and 600 parts to the foot	1.50	.14

TRIANGULAR BOXWOOD SCALES WITH WHITE EDGES.

1674.	White-Edge Scale, 6-inch, divided same as No. 1655	\$1.50	\$0.11
1675.	White-Edge Scale, 12-inch, divided same as No. 1656	2.50	.14
1678.	White-Edge Scale, 6-inch, divided same as No. 1660	1.50	.11
1679.	White-Edge Scale, 12-inch, divided same as No. 1660	2.50	.14
1682.	White-Edge Scale, 12-inch, divided same as No. 1665	2.50	.14
1684.	White-Edge Scale, 12-inch, divided same as No. 1670	2.50	.14

METALLIC TRIANGULAR SCALES.

The Metallic Triangular Scales are made of brass tubing with the ends closed, nicked with a dull finish, and weigh about three and one-half ounces.

The liability of the wood scales to crack, warp, or twist, the chipping of their edges, and their variation from standard measurement, are well known to all who have used them. These objections have been overcome in the metallic scale.

1690.	Metallic Triangular Scale, 12-inch, divided same as No. 1656.....	\$2.50	\$0.16
1692.	Metallic Triangular Scale, 12-inch, divided same as No. 1660.....	2.50	.16
1694.	Metallic Triangular Scale, 12-inch, divided same as No. 1665.....	2.50	.16
1698.	Guard for Triangular Scale (preventing all errors)..	.20	.02

METRIC SCALES AND RULES.

No.		PRICE.	POST.
1700.	Flat Boxwood Scale, 20 centimeters, divided to millimeters and $\frac{1}{2}$ millimeters.....	\$0.60	\$0.04
1701.	Flat Boxwood Scale, 30 centimeters, divided to millimeters and $\frac{1}{2}$ millimeters.....	.75	.06
1702.	Flat Boxwood Scale, 50 centimeters, divided to millimeters and $\frac{1}{2}$ millimeters.....	1.50	.18
1703.	Flat White-Edge Scale, 20 centimeters, divided to millimeters and $\frac{1}{2}$ millimeters.....	1.00	.12
1704.	Flat White-Edge Scale, 30 centimeters, divided to millimeters and $\frac{1}{2}$ millimeters.....	1.25	.14
1706.	Triangular Boxwood Scale, 20 centimeters, divided to .01, .02, .03, .05, .025, .0125.....	1.25	.12
1707.	Triangular Boxwood Scale, 30 centimeters, divided to .01, .02, .03, .05, .025, .0125.....	1.50	.14
1710.	Triangular Boxwood Scale, 30 centimeters, divided to millimeters and $\frac{1}{2}$ millimeters, also to 10ths, 12ths and 16ths of inches, and 100ths of a foot ...	2.00	.14
1712.	Triangular White-Edge Scale, 30 centimeters, divided same as No. 1706.....	2.50	.14
1714.	Triangular White-Edge Scale, 30 centimeters divided same as No. 1710.....	3.00	.14
1718.	Flexible Wood Rule, four feet, eight fold, divided to millimeters and 16ths of inches, and with spring joints50	.05

PAPER SCALES.

1724.	Paper Scale, $1\frac{1}{4}$ -inch wide, 12 inches long, graduations on one edge inches and 10ths, and the other feet and 100ths.....	\$0.10	\$0.02
1725.	Paper Scale, same as 1724, edges 20 and 40 parts to the inch.....	.10	.02
1726.	Paper Scale same as 1724, edges 16 and 48 parts to the inch.....	.10	.02
	Paper Scales, printed on card-paper, 19 inches long, for architects and engineers, as follows :		
1727.	Series A contains 6 scales, one each divided to $\frac{1}{4}$, $\frac{1}{2}$, $\frac{3}{4}$, 1, $1\frac{1}{2}$, and 3 inches to the foot, each scale.....	.20	.04
1728.	Series B contains 6 scales, one each divided $\frac{3}{8}$, $\frac{1}{2}$, $\frac{5}{8}$, $\frac{3}{4}$, $\frac{7}{8}$, and 1 inches to the foot, each scale.....	.20	.04
1729.	Series C contains 6 scales, one each divided to 10, 20, 30, 40, 50 and 60 parts to the inch, each scale	.20	.04

THACHER'S CALCULATING-INSTRUMENT.

No.		PRICE.
1730.	Thacher's Calculating-Instrument, with cylinder 18 inches long. Performs a great variety of useful calculations with rapidity and accuracy. In mahogany box and with instruction book.....	\$35.00

BOXWOOD AND IVORY POCKET-RULES, ETC.

No.		PRICE.	POST.
1735.	Boxwood Rule, one foot, four fold, 8ths and 16ths of inches	\$0.10	\$0.03
1736.	Boxwood Rule, one foot, four fold, edge-plates, 8ths and 16ths of inches18	.03
1737.	Boxwood Rule, one foot, four fold, brass edges, bound, 8ths and 16ths of inches.....	.30	.04
1740.	Boxwood Rule, two feet, four fold, 8ths and 16ths of inches.....	.15	.05
1741.	Boxwood Rule, two feet, four fold, edge-plates, 8ths, 10ths, 12ths and 16ths of inches, and drafting-scales.....	.25	.05
1742.	Boxwood Rule, two feet, four fold, brass edges, bound, 8ths, 10ths, 12ths and 16ths of inches, and drafting scales.....	.50	.06
1743.	Boxwood Rule, two feet, four fold, edge-plates, 8ths, 10ths, 12ths and 16ths of inches, and drafting-scales, and inside beveled edges.....	.50	.06
1745.	Boxwood Caliper-Rule, one foot, four fold, edge-plates, 8ths, 10ths, 12ths and 16ths of inches.....	.40	.04
1747.	Ivory Rule, one foot, four fold, edge-plates, 8ths, 10ths, 12ths and 16ths of inches.....	1.40	.12
1748.	Ivory Rule, one foot, four fold, edge-plates, 8ths, 10ths, 12ths and 16ths of inches and 100ths of a foot.....	1.85	.12
1749.	Ivory Rule, one foot, four fold, German silver edges, bound, divided like No. 1748.....	2.50	.13
1750.	Ivory Caliper-Rule, one foot, four fold, edge-plates, divided like No. 1748.....	2.15	.13
1751.	Ivory Caliper-Rule, one foot, four fold, German silver edges, bound, divided like No. 1747.....	2.85	.13
1753.	Ivory Rule, two feet, four fold, edge-plates, 8ths, 10ths, 12ths and 16ths of inches, and 100ths of a foot.....	4.25	.15
1754.	Ivory Rule, two feet, four fold, German silver edges, bound, 8ths, 10ths, 12ths and 16ths of inches, and drafting-scales.....	5.00	.15

No.		PRICE.	Post.
1756.	Flexible Wood Rule, four feet, eight fold, divided to 16ths of inches, and with spring joints.....	\$0.50	\$0.05
1757.	Flexible Wood Rule, four feet, eight fold, divided to 16ths and 20ths of inches, and with spring joints,	.50	.05
1758.	Boxwood Shrink-Rule, for pattern makers, 24 $\frac{1}{4}$ -inch, 8ths and 16ths of inches.....	1.00	.18
1760.	Boxwood Combination-Rule, one foot, two fold. This is the most convenient and useful pocket-rule ever made; it combines in itself a Carpenter's Rule, Spirit-Level, Square, Plumb, Bevel, Indicator, Brace-Scale, Drafting-Scale of equal parts, T-Square, Protractor, Right-angle Triangle, and with a straight-edge can be used as a Parallel Ruler, all the parts of which, in their separate application, are perfectly reliable.....	2.00	.15

BOXWOOD SLIDE-RULES. (*See page 337.*)

1761.	Carpenters' Slide-Rule, two feet, two fold, with Gunter slide, engineering and octagonal scales, 8ths, 10ths and 16ths of inches, and 100ths of a foot.....	\$1.25	\$0.15
1762.	Faber's Slide-Rule and Calculating-Scale, 10 $\frac{1}{2}$ -inch, with indicator and directions.....	3.75	.20
1763.	Students' Slide-Rule, 10-inch, with indicator and directions.....	1.00	.15
1764.	Engineers' Slide-Rule (Mannheim), 10-inch, divided on white facings, with indicator and directions.....	4.50	.15
1765.	Duplex Slide-Rule, 10-inch, divided on white facings, with indicator, Arithmetical slide and directions.....	6.50	.15
1767.	Duplex Slide-Rule, 10-inch, divided on white facings, with indicator and both Arithmetical and Trigonometrical slides and directions.....	8.00	.20
1768.	Stadia Slide-Rule, 20-inch, divided on white facings. This rule is designed to solve the equations generally used in stadia measurements.....	13.50	.35
	The Slide-Rule Manual, by Wm. Cox.....	.50	
	Manual of The Duplex and Mannheim Slide-Rules	.75	
	General Treatise on Slide-Rules.....	1.00	

(For cuts of Pocket and Slide-Rules, see page 337.)

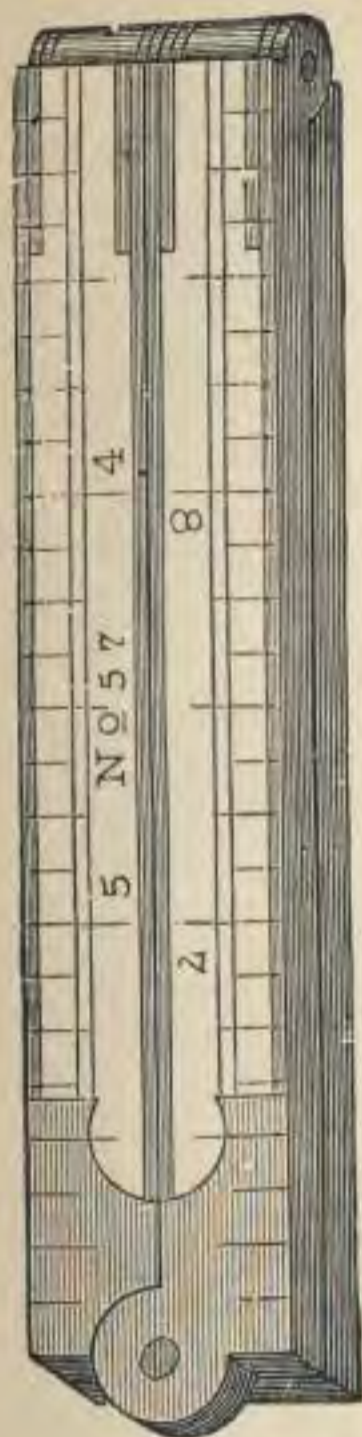

1737.

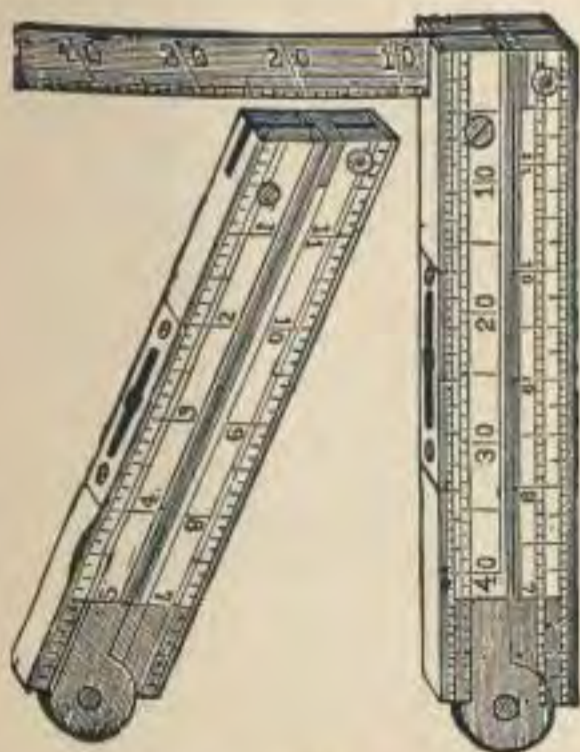

1760.



1762.

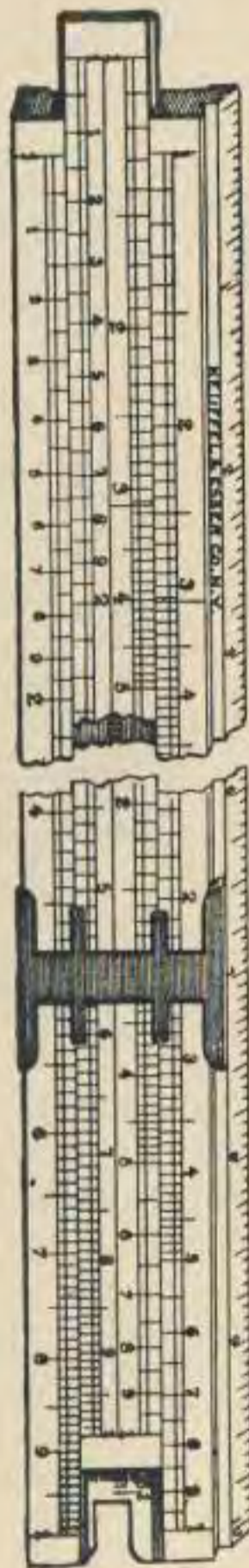

1764.

(For prices, see pages 335 and 336.)

STANDARD STEEL RULES.

No.		PRICE.	POST.	No.		PRICE.	POST.
1770.	3-inch.....	\$0.35	\$0.02	1775.	18-inch.....	\$2.00	\$0.20
1772.	6 "65	.05	1776.	24 "	2.75	.30
1774.	12 "	1.25	.15	1777.	36 "	7.00	.50

These rules are divided on four edges in parts of inches as follows : 10, 20, 50, 100 ; 12, 24, 48 ; 16, 32, 64 ; 8.

STANDARD METRIC STEEL RULES.

1780.	$\frac{1}{10}$ -meter.....	\$0.45	\$0.03	1783.	$\frac{1}{2}$ -meter.....	\$ 2.00	\$0.22
1781.	$\frac{1}{5}$ "85	.14	1784.	1 "	8.00	.55
1782.	$\frac{3}{10}$ "	1.25	.16				

These rules are divided on three edges to millimeters and one edge to fifths of millimeters.

TRIANGULAR STEEL RULES.

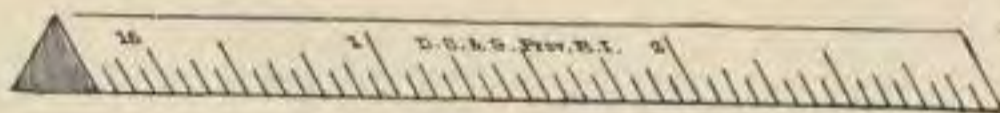

1785.

1785.	3-inch.....	\$0.50	\$0.03	1787.	6-inch.....	\$1.00	\$0.13
1786.	4 "70	.05	1788.	12 "	2.00	.15

These rules are divided on three edges in parts of inches as follows : 20, 50, 100 ; 12, 24, 48 ; 16, 32, 64.

SQUARE STEEL RULES.

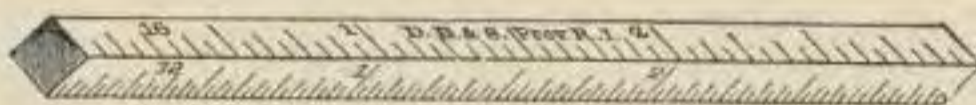

1790.

1790.	3-inch.....	\$0.45	\$0.03	1792.	6-inch.....	\$0.90	\$0.13
1791.	4 "60	.05				

These rules are divided on four edges in parts of inches as follows : 16, 32, 64, 100.

STEEL STRAIGHT-EDGES. (SQUARE EDGES.)

	NICKEL-			NICKEL-					
	PLAIN.	PLATED.	POST.	PLAIN.	PLATED.	POST.			
1800.	15-inch..	\$0.90	\$1.15	\$0.15	1804.	36-inch..	\$3.00	\$ 3.50	\$0.40
1801.	18 " ..	1.00	1.25	.18	1805.	42 " ..	4.00	4.50	.50
1802.	24 " ..	1.50	1.90	.24	1806.	48 " ..	6.00	6.60	.65
1803.	30 " ..	2.25	2.70	.30	1807.	60 " ..	8.00	8.70

STEEL STRAIGHT-EDGES, NICKEL-PLATED.
(ONE EDGE BEVELED.)

No.		PRICE.	Post.	No.		PRICE.	Post.
1810.	18-inch.....	\$2.00	\$0.18	1813.	36-inch.....	\$5.00	\$0.40
1811.	24-inch.....	3.00	.24	1814.	42-inch.....	6.50	.50
1812.	30-inch.....	4.00	.30	1815.	48-inch.....	8.00	.65

MAHOGANY STRAIGHT-EDGES, AMBER-LINED.
(ONE EDGE BEVELED.)



1820.

1820.	18-inch.....	\$0.90	\$0.06	1823.	36-inch.....	\$1.90	\$0.25
1821.	24-inch.....	1.10	.16	1824.	42-inch.....	2.50	.32
1822.	30-inch.....	1.25	.18	1825.	48-inch.....	3.00	.40

MAHOGANY STRAIGHT-EDGES, EBONY-LINED.
(SQUARE EDGES.)



1830.

1830.	24-inch.....	\$0.50	\$0.08	1833.	42-inch.....	\$1.00	\$0.32
1831.	30-inch.....	.60	.12	1834.	48-inch.....	1.35	.40
1832.	36-inch.....	.80	.15	1835.	60-inch.....	2.00

HARD RUBBER STRAIGHT-EDGES.
(SQUARE EDGES.)



1840.

1840.	18-inch.....	\$0.50	\$0.06	1843.	36-inch.....	\$1.35	\$0.25
1841.	24-inch.....	.75	.08	1844.	42-inch.....	1.75	.32
1842.	30-inch.....	1.00	.18	1845.	48-inch.....	2.25	.40

HARDWOOD STRAIGHT-EDGES. (ONE EDGE BEVELED.)



1850.

No.	PRICE.	Post.	No.	PRICE.	Post.
1850.	18-inch.....\$0.25	\$0.06	1854.	42-inch.....\$0.50	\$0.24
1851.	24-inch..... .35	.08	1855.	48-inch..... .65	.32
1852.	30-inch..... .40	.12	1856.	60-inch..... 1.00
1853.	36-inch..... .45	.15	1857.	72-inch..... 1.25

T-SQUARES.

MAHOGANY T-SQUARES WITH AMBER EDGES AND FIXED HEAD.

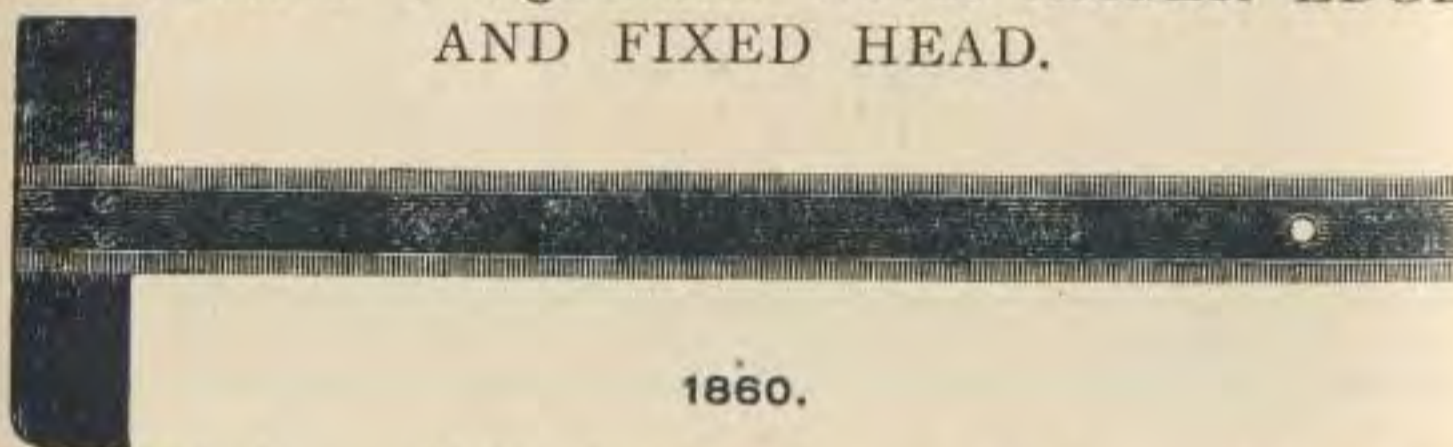

1860.

1860.	18-inch.....\$1.10	\$0.25	1863.	36-inch.....\$2.35	\$0.50
1861.	24-inch..... 1.40	.35	1864.	42-inch..... 2.75	.55
1862.	30-inch..... 1.90	.45	1865.	48-inch..... 3.35

MAHOGANY T-SQUARES WITH AMBER EDGES AND SHIFTING HEAD.

1870.	18-inch.....\$1.85	\$0.30	1873.	36-inch.....\$2.90	\$0.55
1871.	24-inch..... 2.25	.40	1874.	42-inch..... 3.25	.60
1872.	30-inch..... 2.60	.50	1875.	48-inch..... 3.75

RUBBER BLADE T-SQUARES, HARDWOOD HEAD, FIXED.

1880.	18-inch.....\$0.90	\$0.25	1882.	30-inch.....\$1.60	\$0.45
1881.	24-inch..... 1.25	.35	1883.	36-inch..... 2.00	.50

RUBBER BLADE T-SQUARES, HARDWOOD HEAD, SHIFTING.

No.		PRICE.	POST.	No.		PRICE.	POST.
1888.	18-inch.....	\$1.60	\$0.30	1890.	30-inch.....	\$2.35	\$0.50
1889.	24-inch.....	2.00	.40	1891.	36-inch.....	2.75	.55

STEEL BLADE T-SQUARES, NICKEL-PLATED, WITH FIXED JAPANNED IRON HEAD.

1896.	18-inch.....	\$3.00	\$0.35	1898.	30-inch.....	\$4.50	\$0.45
1897.	24-inch.....	3.50	.40	1899.	36-inch.....	5.50	.50

STEEL BLADE T-SQUARES, NICKEL-PLATED, WITH SHIFTING JAPANNED IRON HEAD.

1902.	18-inch.....	\$4.25	\$0.45	1904.	30-inch.....	\$5.75	\$0.55
1903.	24-inch.....	5.00	.50	1905.	36-inch.....	6.75	.60

HARDWOOD T-SQUARES, FIXED HEAD.

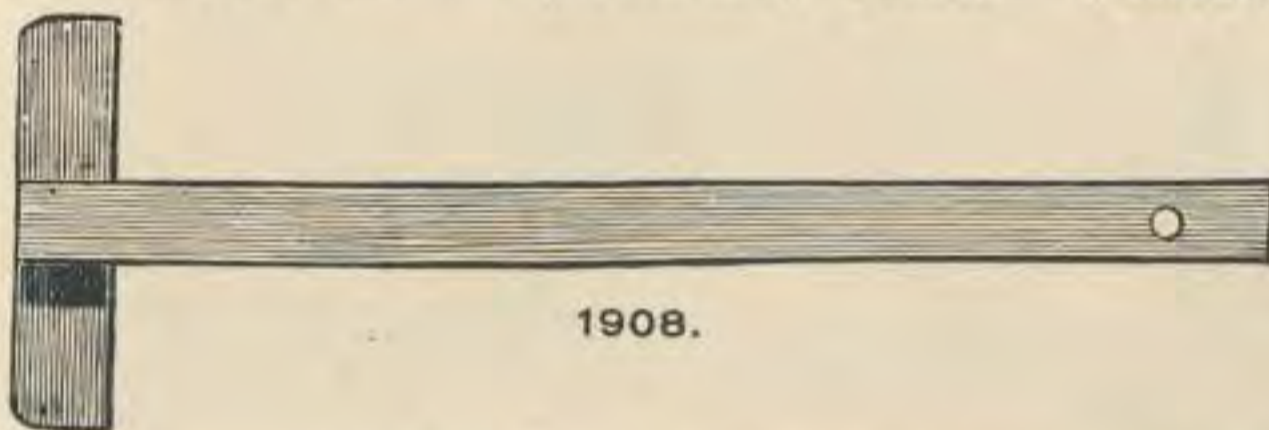

1908.	15-inch.....	\$0.30	\$0.15	1911.	30-inch.....	\$0.50	\$0.45
1909.	20-inch.....	.40	.25	1912.	40-inch.....	.75	.60
1910.	25-inch.....	.45	.35	1913.	50-inch.....	1.00

HARDWOOD T-SQUARES, SHIFTING HEAD.

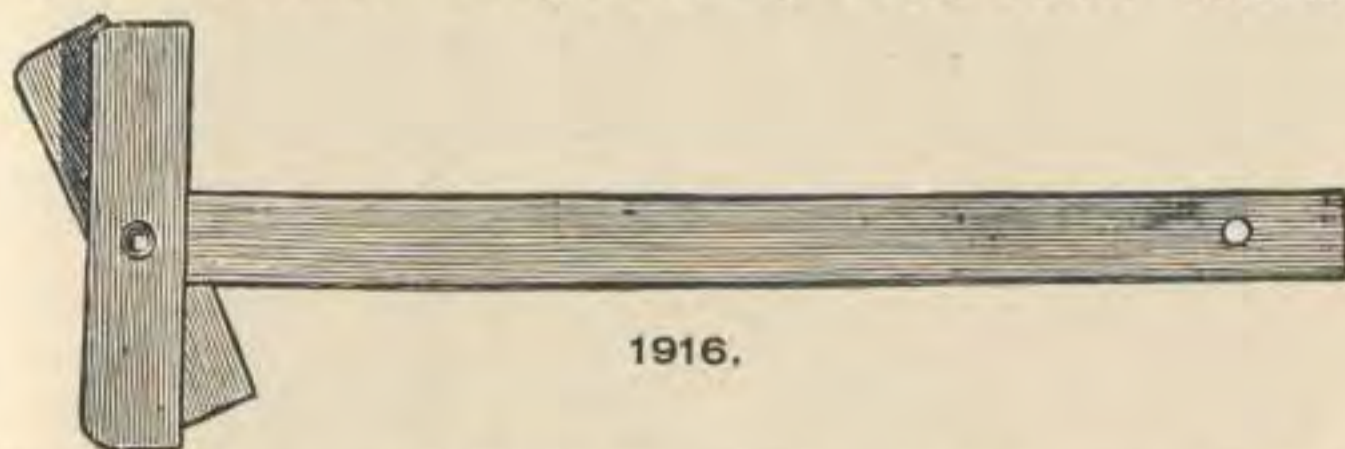

1916.	15-inch.....	\$0.80	\$0.20	1919.	30-inch.....	\$1.00	\$0.50
1917.	20-inch.....	.90	.30	1920.	40-inch.....	1.25	.65
1918.	25-inch.....	.95	.40	1921.	50-inch.....	1.50

No.		PRICE.	POST.
1924.	“ R. P. I.” Hardwood T-Square, 30-inch blade with beveled edges, fixed curved head, superior.....	\$1.25	\$0.45
1926.	“ R. P. I.” Hardwood T-Square, 30-inch blade with beveled edges, shifting curved head, superior.....	2.00	.50

T-SQUARES WITH DEANE'S PATENT SWIVEL AND ADJUSTMENT.

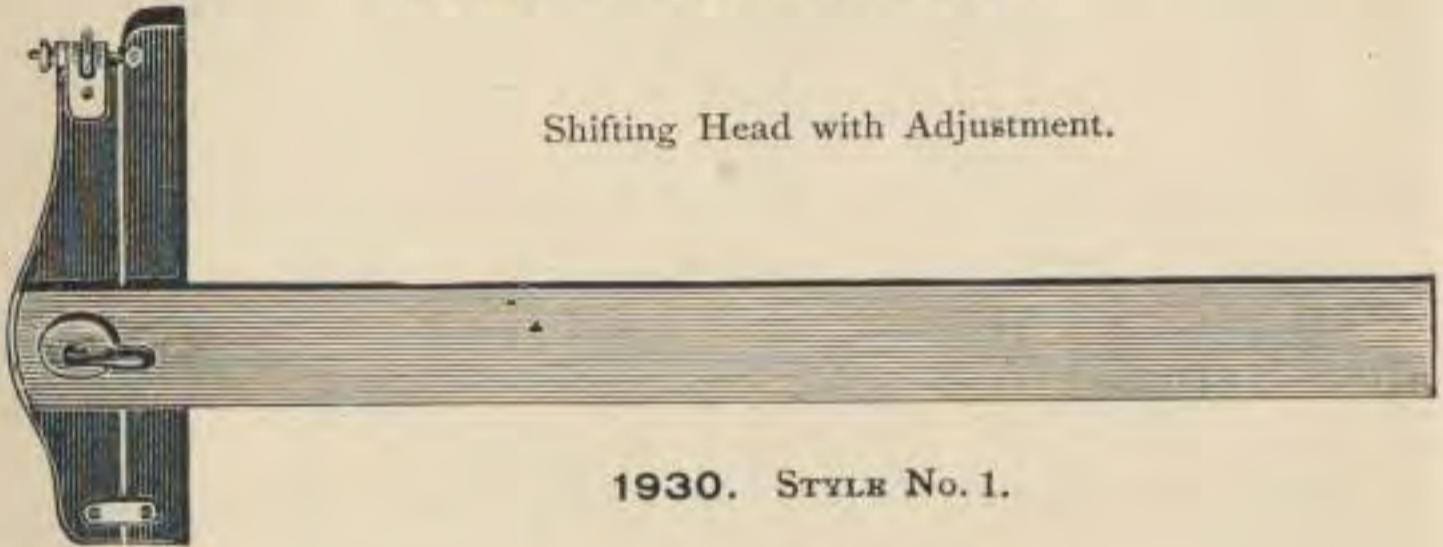

Shifting Head with Adjustment.

1930. STYLE No. 1.

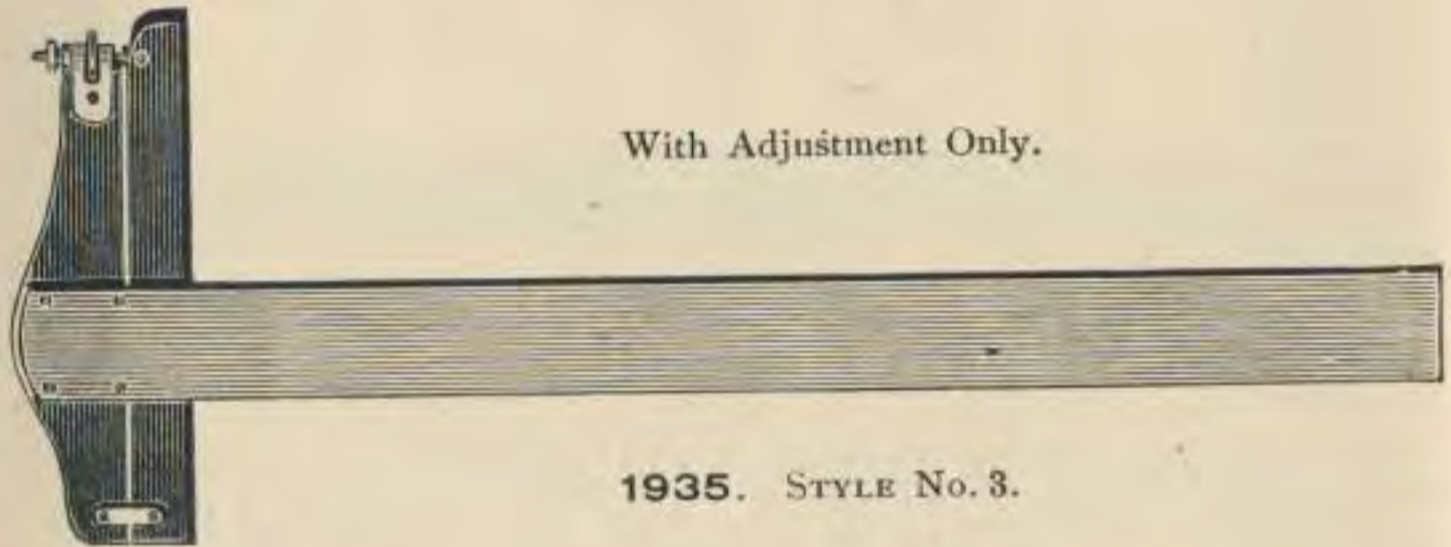

With Adjustment Only.

1935. STYLE No. 3.

1930.	24-inch, Mahogany Blade, Amber Edges, Style No. 1.....	\$3.65	\$0.40
1931.	30-inch, Mahogany Blade, Amber Edges, Style No. 1.....	4.15	.45
1932.	36-inch, Mahogany Blade, Amber Edges, Style No. 1.....	4.75	.50
1935.	24-inch, Mahogany Blade, Amber Edges, Style No. 3.....	3.15	.40
1936.	30-inch, Mahogany Blade, Amber Edges, Style No. 3.....	3.65	.45
1937.	36-inch, Mahogany Blade, Amber Edges, Style No. 3.....	4.25	.50

DRAWING-TABLES.



1950.

No.		PRICE.
1950.	Drawing-Table, hardwood top, 30 x 20 inches.....	\$7.00
1953.	Drawing-Table, ash top, 24 x 22 inches.....	8.00
1954.	Drawing-Table, ash top, 24 x 22 inches, and with instru- ment shelf, 24 x 7 inches	9.00
1956.	Drawing-Table, black walnut top, 26 x 22 inches, instru- ment shelf 26 x 7 inches, two instrument drawers, orna- mented stand	12.00
1953.	Drawing-Table, ash top, 26 x 22 inches, with instrument shelf and two drawers and with folding arm and plain shelf, ornamented stand	17.00

NOTE.—These Tables are adjustable for horizontal and angular motion and for heights about 30 to 44 inches. The shelves and drawers remain level when the top is inclined. They are mounted on an iron stand with castors.

DRAWING-BOARDS AND TRESTLES.

No.		PRICE.
1960.	Drawing-Board, pinewood, 14 x 10 inches.....	\$0.35
1962.	Drawing-Board, pinewood, 20 x 15 inches, tongue and groove ends75
1964.	Drawing-Board, pinewood, 28 x 20 inches, tongue and groove ends	1.50
1966.	Drawing-Board, pinewood, 40 x 28 inches, tongue and groove ends	2.50
1967.	Drawing-Board, pinewood, 55 x 33 inches, dovetailed cleats on under side.....	7.00
1970.	Drawing-Board, with mahogany frame, and removable pinewood center, 18 x 13 inches.....	3.00
1972.	Drawing-Board, with mahogany frame, and removable pinewood center, 25 x 17 inches	4.00
(Drawing-Boards and Trestles of any size made to order.)		
1975.	Pinewood Horses, 37 inches high, 35 inches long, with removable sloping ledges. Per pair.....	5.00
1977.	Folding Trestle, hardwood, 37 inches high, 33 inches long, 26 inches wide.....each	8.00
1978.	Folding Trestle, hardwood, 37 inches high combined with adjustable Drawing-Board of pinewood, 42 x 31 inches, and hinged to the Trestle. All folding compactly....each	14.00

TRIANGLES

OPEN STEEL TRIANGLES. NICKEL-PLATED.

30° x 60° x 90°.

No.		PRICE.	Post.	No.		PRICE.	Post.
1982.	6-inch.....	\$3.20	\$0.15	1986.	10½-inch.....	\$4.25	\$0.25
1984.	8-inch.....	3.85	.20	1989.	15-inch.....	6.50	.40

45° x 45° x 90°.

1992.	6½-inch.....	3.50	.18	1996.	10-inch.....	5.50	\$0.35
1994.	8-inch.....	4.25	.25	1998.	12-inch.....	6.50	.45

OPEN GERMAN SILVER TRIANGLES.

30° x 60° x 90°.

2002.	6-inch.....	\$2.50	\$0.15	2006.	10-inch.....	\$4.00	\$0.25
2004.	8-inch.....	3.00	.20	2008.	12-inch.....	5.00	.30

45° x 45° x 90°.

2012.	6-inch.....	2.75	.18	2016.	10-inch.....	5.00	.35
2014.	8-inch.....	4.00	.25	2018.	12-inch.....	6.50	.45

TRANSPARENT AMBER TRIANGLES.

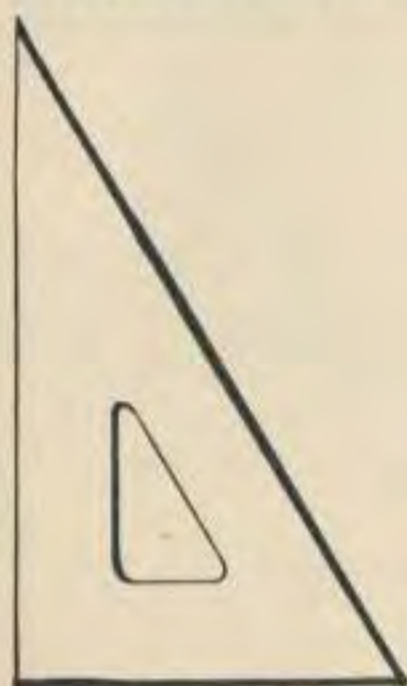

2022.

30° x 60° x 90°.

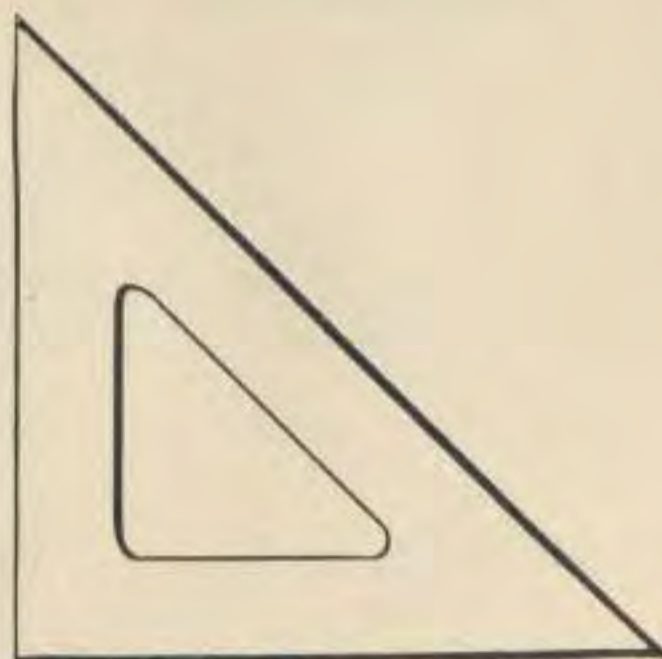

2036.

45° x 45° x 90°.

(For prices, see page 346.)

TRANSPARENT AMBER TRIANGLES.

30° x 60° x 90°.

No.		PRICE.	POST.	No.		PRICE.	POST.
2022.	4-inch.....	\$0.25	\$0.03	2028.	10-inch.....	\$0.75	\$0.08
2024.	6-inch.....	.40	.04	2030.	12-inch.....	1.00	.18
2026.	8-inch.....	.55	.06	2032.	14-inch.....	1.65	.20

45° x 45° x 90°.

2036.	4-inch.....	.35	.04	2042.	8-inch.....	.75	.08
2038.	6-inch.....	.55	.05	2044.	10-inch.....	1.10	.18
2040.	7-inch.....	.65	.07	2046.	12-inch.....	1.65	.20

HARD RUBBER TRIANGLES.



2052.

30° x 60° x 90°.



2074.

45° x 45° x 90°.

30° x 60° x 90°.

2052.	4-inch.....	\$0.20	\$0.03	2058.	10-inch.....	\$0.65	\$0.08
2054.	6-inch.....	.30	.04	2060.	12-inch.....	.90	.10
2055.	7-inch.....	.35	.05	2062.	14-inch.....	1.25	.20
2056.	8-inch.....	.45	.06	2064.	16-inch.....	1.50	.25

45° x 45° x 90°.

2074.	4-inch.....	.25	.04	2078.	8-inch.....	.65	.08
2075.	5-inch.....	.35	.05	2080.	10-inch.....	.95	.10
2076.	6-inch.....	.45	.05	2082.	12-inch.....	1.30	.20
2077.	7-inch.....	.50	.07	2084.	14-inch.....	1.85	.25

Other sizes of Amber or Rubber Triangles to order.

HARDWOOD TRIANGLES, OPEN CENTER,
FRAMED.



2092.

30° x 60° x 90°

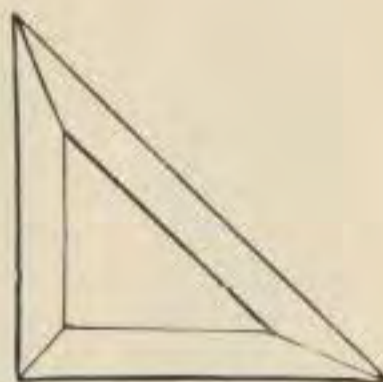

2108.

45° x 45° x 90°

30° x 60° x 90°

No.	Size	PRICE.	POST.
2092.	6-inch.....	\$0.20	\$0.04
2094.	8-inch.....	.25	.06
2096.	10-inch.....	.30	.08

No.	Size	PRICE.	POST.
2098.	12-inch.....	\$0.40	\$0.10
2100.	14-inch.....	.50	.12
2102.	16-inch.....	.60	.18

45° x 45° x 90°

2107.	5-inch.....	.20	.05
2108.	6-inch.....	.25	.05
2109.	7-inch.....	.30	.08

2110.	8-inch.....	.35	.08
2112.	10-inch.....	.40	.10
2114.	12-inch.....	.50	.12

HARDWOOD TRIANGLES, PLAIN.

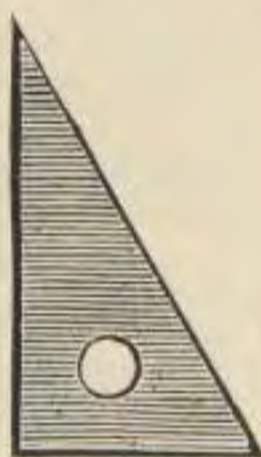

2120.

30° x 60° x 90°

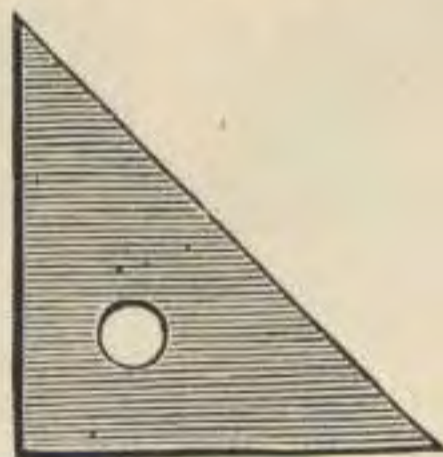

2130.

45° x 45° x 90°

30° x 60° x 90°

2120.	4-inch.....	\$0.08	\$0.03
2122.	6-inch.....	.10	.04

2124.	8-inch.....	\$0.12	\$0.06
2126.	10-inch.....	.15	.08

45° x 45° x 90°

2130.	4-inch.....	.10	.04
2131.	5-inch.....	.12	.05

2132.	6-inch.....	.15	.05
2134.	8-inch.....	.18	.08

HARD RUBBER LETTERING TRIANGLES.



2140.

No.		PRICE.	POST.
2140.	Lettering Triangles for Block Letters, $3\frac{1}{2}$ -inch, three in a set. Per set.....	\$1.35	\$0.12



2145.

2145.	Lettering Triangles for Shaded Letters, $3\frac{1}{2}$ -inch, three in a set. Per set	1.20	.12
-------	---	------	-----

HARD RUBBER TRIANGLES FOR EMBANKMENTS AND ROOF PITCHES.

2150.	Rubber Triangles, seven in a set, for slopes $\frac{1}{4}$ to 1, $\frac{1}{2}$ to 1, $\frac{3}{4}$ to 1, 1 to 1, $1\frac{1}{4}$ to 1, $1\frac{1}{2}$ to 1, 2 to 1. Per set.....	\$2.50	\$0.16
-------	---	--------	--------

SECTION-LINERS.

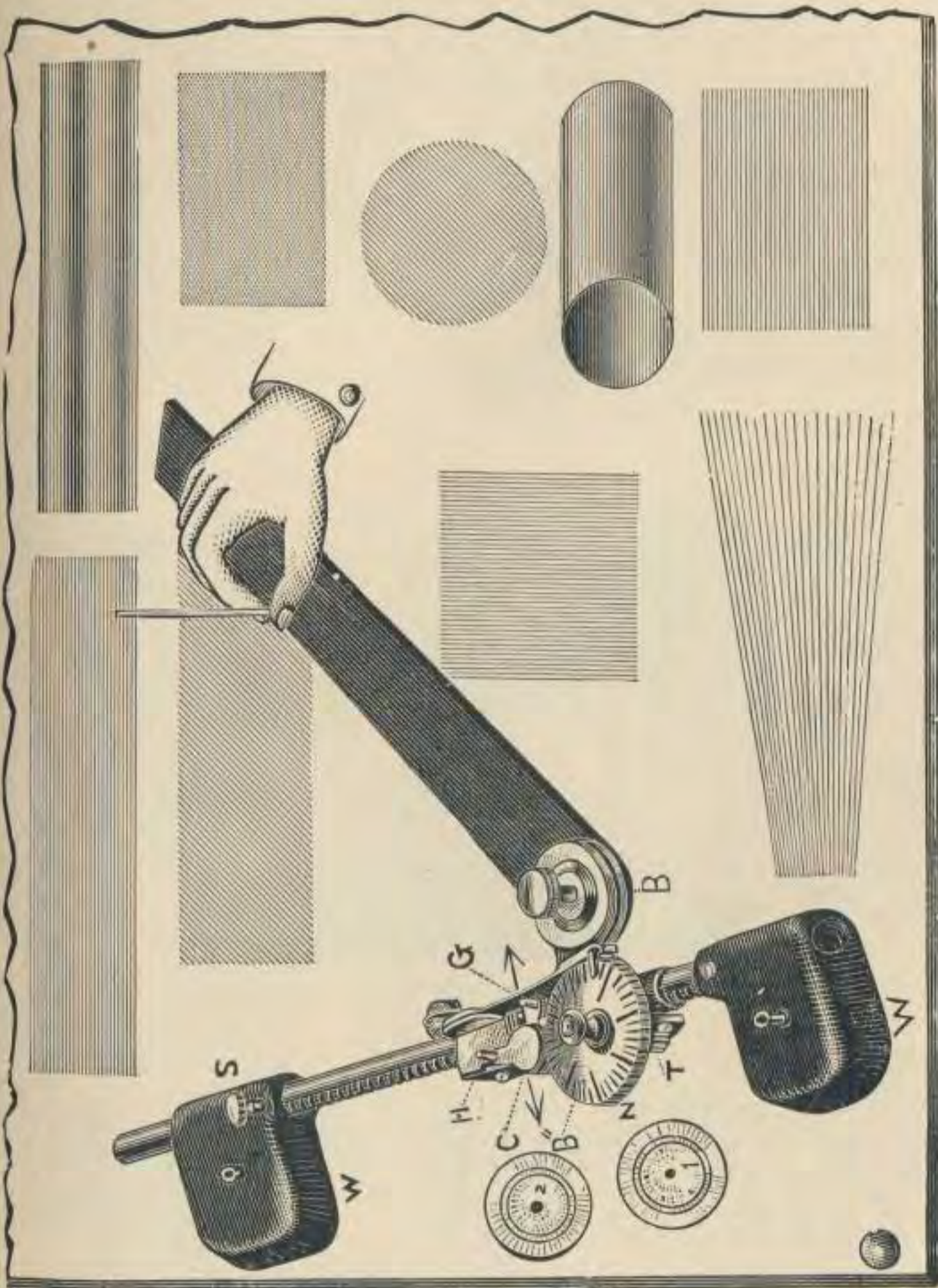

No. 2155. (For price, see page 350.)

This Section-Liner is positive in all its motions, being operated by a rack and pinion movement. The rack-rod passes through two heavy weights and is held securely by clamp-screws. Two needle-pointed pins aid to hold the weights in place when necessary. Lines can be drawn at any angle, in any direction, and on any part of the board.

SECTION-LINERS (*Concluded*).

No.		PRICE.
2155.	Section-Liner with 12-inch rack and 12-inch blade.....	\$6.50
2156.	Section-Liner with 14-inch rack and 14-inch blade..... Longer blades to order.	7.50

Each of these Section-Liners is packed in neat case with printed directions for use.

Two plain notched wheels are furnished with each instrument for producing 64 and 100 parts to the inch. Extra wheels for either 10, 12, 20, 24, 40, 48 and 50 parts to the inch will be furnished for \$1.50 each. These notched wheels when graduated on the face for ruling and measuring combined will cost \$2.25 each.

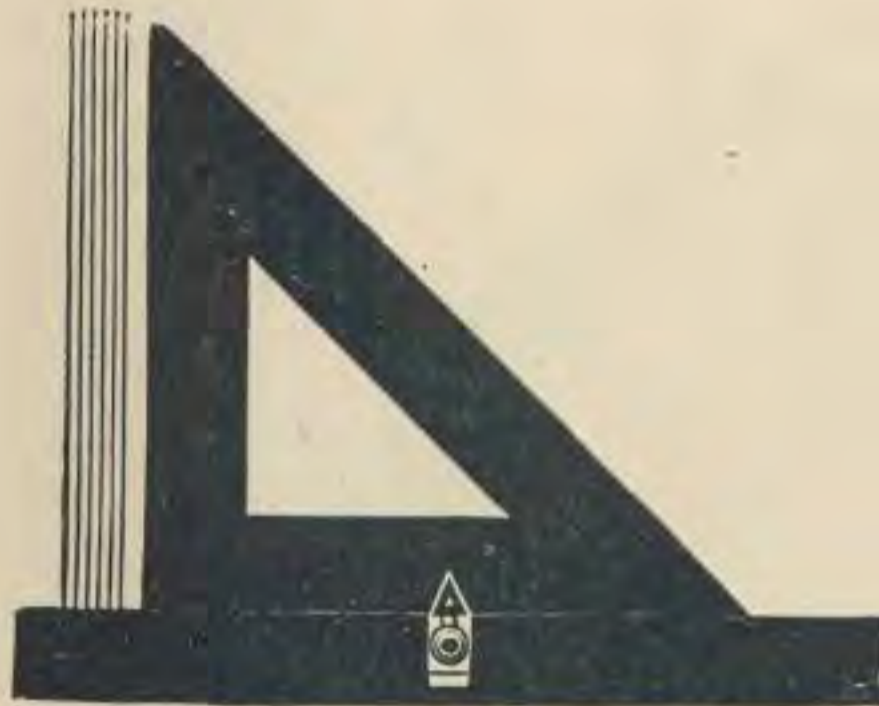

No. 2168.

No.		PRICE.	POST.
2168.	Marion's Section-Liner with 7-inch triangle and 10-inch ruler.....	\$2.00	\$0.20
2169.	Davenport's Simple Section-Liner.....	1.50	.20
2170.	Standard Section-Liner. Especially adapted for school use and mechanical sectional drawing...	1.50	.20
2172.	Bergner's Section-Liner.....	7.50	.30
2175.	Terry's Positive Section-Liner with 12-inch ruler and brace attachment.....	10.00	
2177.	Both's Section-Liner and Scale-Divider, with 14 $\frac{3}{4}$ -inch base, 9-inch rack, 10-inch arm beyond protractor.....	12.00	.40

IRREGULAR CURVES OF HARD RUBBER
AMBER AND WOOD.



NOS. 2180, 2182 AND 2184.

IRREGULAR CURVES OF HARD RUBBER, AMBER AND WOOD.

(See patterns on page 351.)

No.		PRICE.	Post.
2180.	Hard Rubber Curves, Nos 1, 2, 14, 16, 17, 22, 25 and 26. Each.....	\$0.35	\$0.03
	Hard Rubber Curves, Nos. 5, 15, 18, 21 and 23. Each.....	.40	.03
	Hard Rubber Curves, Nos. 3, 4, 13, 19, 20 and 24. Each.....	.50	.05
	Hard Rubber Curve, No. 27.....	.75	.08
	Hard Rubber Curve, No. 28.....	2.25	.18
	Hard Rubber Curve, Logarithmic Spiral, No. 29...	1.50	.13
2182.	Transparent Amber Curves, Nos. 1, 2, 5, 16, 22, 25 and 26. Each.....	.45	.03
	Transparent Amber Curves, Nos. 3, 4, 13, 19 and 20. Each.....	.60	.05
	Transparent Amber Curve, No. 24.....	.75	.05
	Transparent Amber Curve, No. 27.....	.90	.08
2184.	Wood Curves, Nos. 1, 5, 21, 25 and 26. Each...	.20	.03
	Wood Curves, Nos. 3, 4, 13, 19, 20 and 24. Each..	.25	.05
	Wood Curve, No. 27.....	.35	.08

ADJUSTABLE CURVE-RULER.



2186.

2186.	Adjustable Curve-Ruler, 14½ inches long.....	\$1.87	\$0.15
2187.	Adjustable Curve-Ruler, 30 inches long.....	2.87	.35

These rulers can be instantly adjusted and retained to any form of curve.

This tool is recommended by architects and draftsmen, and meets a long-felt want. It is well made, neatly finished and nickel-plated.

ELLIPSES, HYPERBOLAS AND PARABOLAS.

2190.	Hard Rubber Ellipses, 6 in a set, 2 to 4½-inch. Per set.....	\$1.50	\$0.13
2191.	Hard Rubber Ellipses, 10 in a set, 1½ to 6-inch. Per set.....	2.50	.16
2194.	Wood Ellipses, 6 in a set, 2 to 4½-inch. Per set...	1.25	.13
2195.	Wood Ellipses, 10 in a set, 1½ to 6-inch. Per set..	2.00	.16
2200.	Wood Hyperbolas, 8 in a set, 2 to 5½-inch. Per set.....	1.50	.15
2204.	Wood Parabolas, 8 in a set, 1½ to 5½-inch. Per set	1.50	.15

RAILROAD CURVES.



2210.

No.		PRICE.	POST.
	Set of 10 Curves, cut to a scale of inches, from 12 to 120 inches radius, varying every 12 inches.		
2210.	Rubber Curves, in wood box.....	\$7.00	\$0.30
2211.	Wood Curves, in wood box.....	4.50	.30
	Set of 24 Curves, cut to a scale of inches, from 1½ to 24 inches radius, varying every ½-inch up to 10 inches and then every 2 inches up to 24 inches.		
2214.	Rubber Curves, in wood box.....	17.00	.40
2215.	Wood Curves, in wood box.....	10.00	.40
	Set of 10 Curves, cut to a scale of 50 feet to the inch, from 1° to 10°, varying every degree.		
2218.	Rubber Curves, in wood box.....	9.00	.30
2219.	Wood Curves, in wood box.....	6.00	.30
	Set of 20 Curves, cut to a scale of 50 feet to the inch, from 1° to 10°, varying every half degree.		
2222.	Rubber Curves, in wood box.....	18.00	.35
2223.	Wood Curves, in wood box.....	12.00	.35
	Set of 12 Curves, cut to a scale of 100 feet to the inch, from 1° to 12°, varying every degree.		
2226.	Rubber Curves, in wood box.....	10.00	.30
2227.	Wood Curves, in wood box.....	6.75	.30
	Set of 24 Curves, cut to a scale of 100 feet to the inch, from 30' to 12°, varying every 30 minutes.		
2230.	Rubber Curves, in wood box.....	19.00	.40
2231.	Wood Curves, in wood box.....	13.00	.40
	Set of 20 Curves, cut to a scale of 200 feet to the inch, from 1° to 20°, varying every degree.		
2234.	Rubber Curves, in wood box.....	15.00	.35
2235.	Wood Curves, in wood box.....	10.00	.35
	Set of 20 Curves, cut to a scale of 400 feet to the inch, from 30' to 10°, varying every 30 minutes.		
2238.	Rubber Curves, in wood box.....	14.00	.35
2239.	Wood Curves, in wood box.....	9.50	.35

PARALLEL RULERS.



2250.

EBONY PARALLEL RULERS.

No.		PRICE.	POST.	No.		PRICE.	POST.
2250.	6-inch.....	\$0.30	\$0.04	2253.	15-inch.....	\$1.00	\$0.18
2251.	9-inch.....	.50	.06	2254.	18-inch.....	1.25	.20
2252.	12-inch.....	.75	.08	2255.	24-inch.....	2.00	.24

HARD RUBBER PARALLEL RULERS.

2260.	6-inch.....	\$0.75	\$0.04	2262.	12-inch.....	\$1.25	\$0.16
2261.	9-inch.....	1.00	.06	2263.	15-inch.....	1.50	.18

EBONY PARALLEL RULERS, ON ROLLERS.

2270.	9-inch.....	\$2.75	\$0.20	2272.	15-inch.....	\$4.00	\$0.30
2271.	12-inch.....	3.25	.25	2273.	18-inch.....	5.00	.35

HARD RUBBER PARALLEL RULERS, ON ROLLERS.

2275.	9-inch.....	\$3.50	\$0.20	2277.	15-inch.....	\$5.00	\$0.30
2276.	12-inch.....	4.25	.25	2278.	18-inch.....	6.00	.35

EBONY PARALLEL RULERS, ON ROLLERS.

WITH WHITE EDGES, DIVIDED $\frac{1}{8}$, $\frac{1}{4}$, $\frac{1}{2}$, 1 INCH TO THE FOOT.

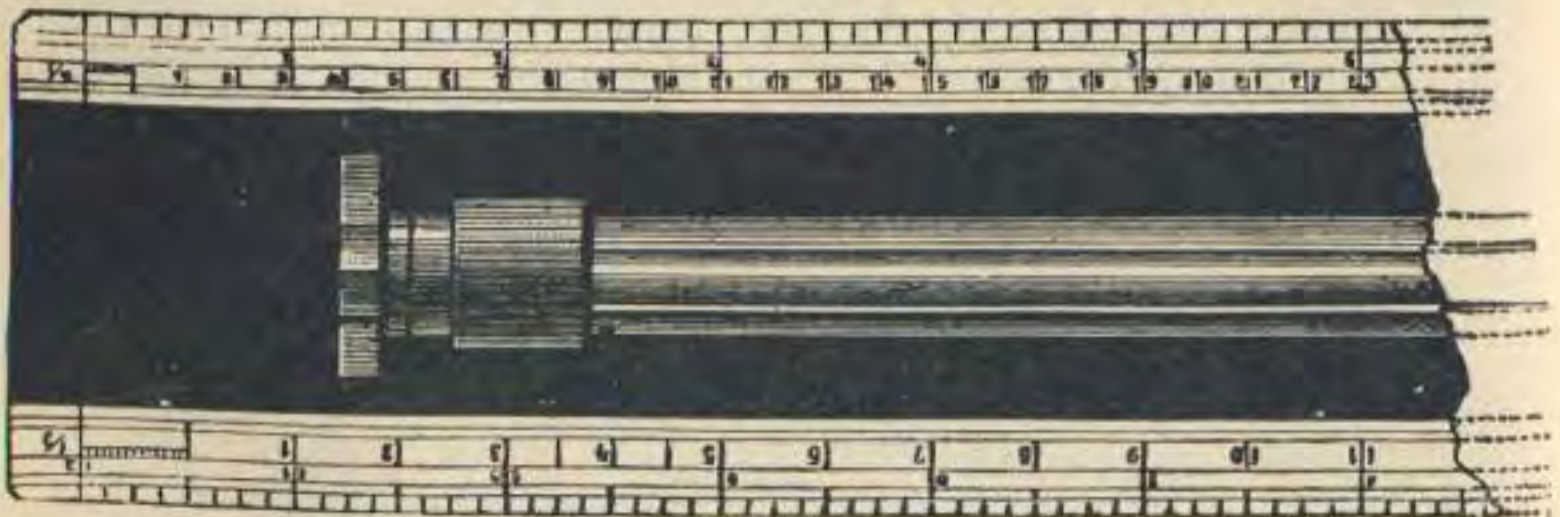

2280.

2280.	12-inch.....	\$5.00	\$0.25	2282.	18-inch.....	\$7.50	\$0.35
2281.	15-inch.....	6.50	.30				

BRASS PARALLEL RULERS, ON ROLLERS.

No.		PRICE.	Post.	No.		PRICE.	Post.
2285.	9-inch.....	\$7.25	\$0.30	2287.	15-inch.....	\$10.00	\$0.50
2286.	12-inch.....	8.50	.40	2288.	18-inch.....	12.00	

GERMAN SILVER PARALLEL RULERS,
ON ROLLERS.

2292.	9-inch.....	\$8.50	\$0.30	2294.	15-inch.....	\$12.00	\$0.50
2293.	12-inch.....	10.00	.40	2295.	18-inch.....	15.00	

PANTOGRAPHS FOR ENLARGING OR
REDUCING DRAWINGS.

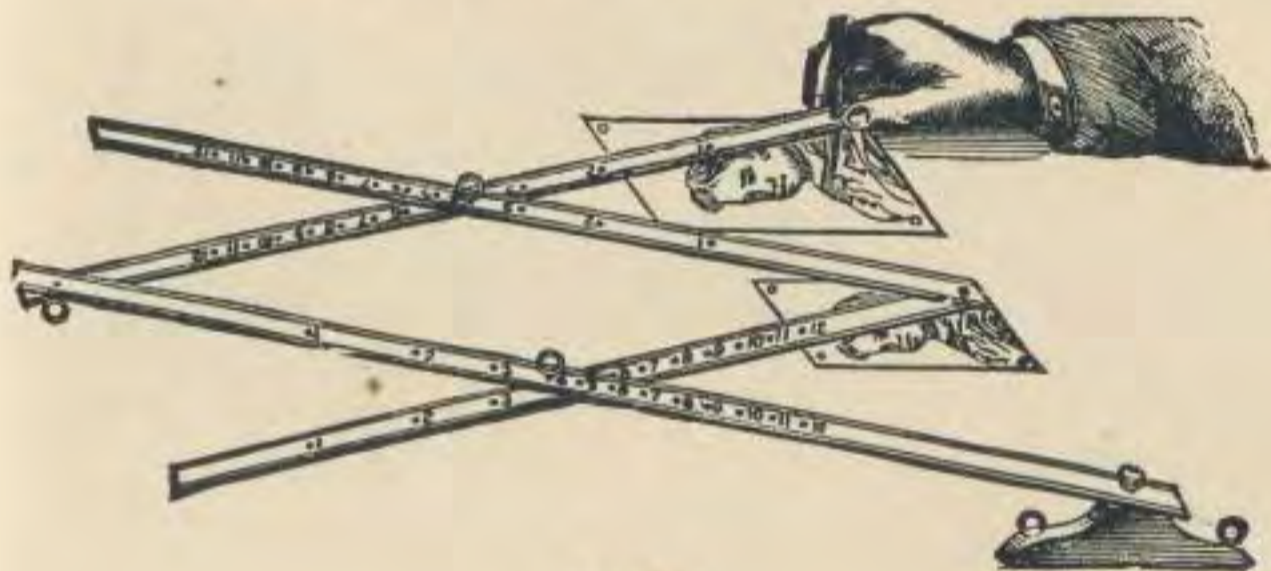

2300.

2300.	Pantograph, hardwood, brass mountings, with arms 21 inches long.....	\$1.75	\$0.25
2302.	Pantograph, hardwood, nickel-plated mountings, with arms 18 to 20 inches long.....	2.50	.25
2304.	Pantograph, hardwood, brass mountings, with arms 22 inches long.....	3.50	.30
2306.	Pantograph, hardwood, brass mountings, with arms 41 inches long.....	5.00	.50

DRAWING-PAPER.

ARCHITECTS' PAPER FOR PLANS.

WHITE, STRONG, SMOOTH SURFACE.

No.		PRICE.	POST.
2350.	Medium, 23 x 18-inch, per sheet 6 cents ; per quire..	\$1.25	\$0.48
2352.	Super Royal, 28 x 20-inch, per sheet, 8 cents ; per quire.....	1.75	.65
2355.	30 inches wide, per roll of 10 yards.....	1.25	.40
2356.	36 inches wide, per roll of 10 yards.....	1.50	.50
2357.	42 inches wide, per roll of 10 yards.....	1.75	.60

WHATMAN'S DRAWING-PAPERS.

SELECTED, BEST QUALITY, GRAINED SURFACE.

2360.	Demy, 20 x 15-inch, per sheet, 5 cents ; per quire...	\$0.95	\$0.28
2361.	Medium, 22 x 17-inch, per sheet, 7 cents ; per quire..	1.40	.36
2362.	Royal, 24 x 19-inch, per sheet, 9 cents ; per quire...	1.80	.43
2363.	Super Royal, 27 x 19-inch, per sheet, 10 cents ; per quire.....	2.10	.53
2365.	Imperial, 30 x 22-inch, per sheet, 17 cents ; per quire.....	3.00	.66
2368.	Double Elephant, 40 x 26-inch, per sheet, 25 cents ; per quire	5.75	1.28

WHATMAN'S DRAWING-PAPER.

MOUNTED ON MUSLIN.

2370.	Royal, 24 x 19-inch, per sheet.....	\$0.38	\$0.10
2372.	Imperial, 30 x 22-inch, per sheet.....	.45	.13
2374.	Double Elephant, 40 x 27-inch, per sheet.....	.75	.18

PATENT OFFICE DRAWING-PAPER.

2380.	Patent Office Bristol-Board, 15 x 10-inch, per sheet, 6 cents ; per quire	\$1.20	\$0.30
2381.	Patent Office Bristol-Board, 20 x 15-inch, per sheet, 12 cents ; per quire	2.40	.60
2385.	Patent Office Bristol-Board, printed with border, etc., 15 x 10-inch, per sheet, 10 cents ; per quire..	1.70	.30

DETAIL DRAWING-PAPER, CREAM BUFF TINT.

SUPERIOR QUALITY, IN ROLLS OF 30 TO 40 LBS.

No.		PRICE.	POST.
2390.	36 inches wide, thick, per pound, 29 cents; per yard.....	\$0.15	\$0.12
2391.	42 inches wide, thick, per pound, 29 cents; per yard.....	.20	.20

BLEACHED MANILLA PAPER.

FOR WORKSHOP DRAWINGS, BEST AMERICAN MAKE, IN ROLLS OF ABOUT 50 POUNDS.

2395.	36 inches wide, medium, per pound, 12 cents; per yard.....	\$0.08	\$0.12
2396.	42 inches wide, medium, per pound, 12 cents; per yard.....	.10	.14
2397.	48 inches wide, medium, per pound, 12 cents; per yard.....	.12	
2398.	54 inches wide, medium, per pound, 12 cents; per yard.....	.15	

AMERICAN WHITE ROLL DRAWING-PAPER.

VERY STRONG AND OF EXCELLENT QUALITY, IN ROLLS OF ABOUT 40 POUNDS.

2410.	36 inches wide, smooth surface, per pound, 45 cents; per yard.....	\$0.25	\$0.12
2411.	42 inches wide, smooth surface, per pound, 45 cents; per yard.....	.30	.14
2413.	62 inches wide, smooth surface, per pound, 45 cents; per yard.....	.50	
2414.	72 inches wide, smooth surface, per pound, 50 cents; per yard.....	.65	

EXCÉLSIOR WHITE ROLL DRAWING-PAPER.

IN ROLLS OF ABOUT 40 POUNDS.

2420.	36 inches wide, grained surface, per pound, 40 cents; per yard.....	\$0.20	\$0.12
2421.	42 inches wide, grained surface, per pound, 40 cents; per yard.....	.24	.14

NOTE.—Small quantities of paper must be put on a wooden roller when sent by mail. Several yards can be put on a single roller, with but little extra cost for postage. The pound price for papers Nos. 2390 to 2434 applies only to full rolls.

BEST EGGSHELL DRAWING-PAPER.

IN ROLLS OF ABOUT 40 POUNDS.

No.		PRICE.	POST.
2430.	36 inches wide, pebbled surface, per pound, 50 cents; per yard.....	\$0.33	\$0.13
2431.	42 inches wide, pebbled surface, per pound, 50 cents; per yard.....	.38	.15
2434.	58 inches wide, pebbled surface, per pound, 50 cents; per yard.....	.50	

EGGSHELL DRAWING-PAPER, IN SHEETS.

MOUNTED ON MUSLIN.

2436.	Sheet, 24 x 18 inches, per sheet.....	\$0.82	\$0.06
2437.	Sheet, 30 x 22 inches, per sheet.....	.40	.10
2438.	Sheet, 40 x 27 inches, per sheet.....	.70	.21

MOUNTED DRAWING-PAPER.

WHITE, MOUNTED ON MUSLIN, IN ROLLS OF 10 YARDS.

2450.	American, 36 inches wide, smooth surface, per roll, \$6.80; per yard.....	\$0.85	\$0.25
2451.	American, 42 inches wide, smooth surface, per roll, \$8.20; per yard.....	1.00	.30
2453.	American, 62 inches wide, smooth surface, per roll, \$13.25; per yard.....	1.60	
2454.	American, 72 inches wide, smooth surface, per roll, \$18.00; per yard.....	2.30	
2460.	Eggshell, 36 inches wide, pebbled surface, per roll, \$7.50; per yard.....	1.00	.25
2461.	Eggshell, 42 inches wide, pebbled surface, per roll, \$8.85; per yard.....	1.10	.30
2463.	Eggshell, 58 inches wide, medium thick, pebbled surface, per roll, \$11.75; per yard.....	1.40	
2464.	Eggshell, 58 inches wide, thick, pebbled surface, per roll, \$13.00; per yard.....	1.60	

Large pieces for City, County or State Maps, mounted to order.

DRAWING-PARCHMENT.

2468.	38 inches wide, medium, per roll of 20 yards, \$3.00; per yard.....	\$0.20	\$0.12
2469.	38 inches wide, thick, per roll of 10 yards, \$3.20; per yard.....	.45	.15

TRACING-PAPER.

No.		PRICE.	POST.
2470.	Domestic, common, 27 inches wide, per yard, 7 cents; per roll of 25 yards.....	\$1.25	\$0.40
2472.	Vegetable, 30 inches wide, per yard, 10 cents; per roll of 20 yards.....	1.50	.40
2474.	Bank Note, 36 inches wide, per yard, 10 cents; per roll of 20 yards.....	1.62	.40
2476.	Parchment, 40 inches wide, per yard, 25 cents; per roll of 20 yards.....	4.00	.60
2478.	Bond, 42 inches wide, per yard, 15 cents; per roll of 20 yards.....	2.25	.45
2479.	Manilla, common, 48 inches wide, per yard, 7 cents; per roll of 20 yards.....	1.00	.50
2480.	Vegetable, 25 x 19 inches, per sheet, 10 cents; per quire.....	2.00	.20
2482.	Flaxine, 31 x 21 inches, per sheet, 12 cents; per quire.....	2.50	.25
2484.	Bond, 21 x 16 inches, per sheet, 6 cents; per quire..	1.00	.20
2486.	Bond, 30 x 19 inches, per sheet, 8 cents; per quire..	1.40	.30
2493.	Pounce Powder, in tin shaker, for Tracing-Paper or Tracing-Cloth, each.....	.15	.07

IMPERIAL TRACING-CLOTH.

IN ROLLS OF 24 YARDS, FACE GLAZED AND BACK DULL.

2495.	30 inches wide, per yard, 35 cents; per roll.....	\$6.90	\$0.70
2496.	36 inches wide, per yard, 40 cents; per roll.....	7.60	1.10
2497.	42 inches wide, per yard, 55 cents; per roll.....	10.50	1.25
2498.	48 inches wide, per yard, 70 cents; per roll.....	14.20	
2499.	54 inches wide, per yard, 75 cents; per roll.....	15.00	

PREPARED BLUE-PRINT PAPERS.

BEST QUALITY; READY FOR IMMEDIATE USE.

2506.	Sensitized Paper, 24 inches wide, per yard, 15 cents; per roll of 10 yards.....	\$1.20	\$0.35
2508.	Sensitized Paper, 30 inches wide, per yard, 18 cents; per roll of 10 yards.....	1.50	.45
2510.	Sensitized Paper, 36 inches wide, per yard, 20 cents; per roll of 10 yards.....	1.65	.55
2512.	Sensitized Paper, 42 inches wide, per yard, 22 cents; per roll of 10 yards.....	1.80	.65
2515.	White Ink, for altering Blue-Prints, per bottle.....	.20	.06
2516.	Red Ink, for altering Blue-Prints, per bottle.....	.20	.06

BLUE-PRINT PAPER, NOT PREPARED.

No.		PRICE.	POST.
2520.	24 inches wide, per roll of 10 yards	\$0.80	\$0.35
2522.	30 inches wide, per roll of 10 yards	1.00	.45
2524.	36 inches wide, per roll of 10 yards	1.15	.55
2526.	24 inches wide, per roll of 50 yards	3.20	
2528.	30 inches wide, per roll of 50 yards	4.00	
2530.	36 inches wide, per roll of 50 yards	4.75	

PRINT-FRAMES AND BATH-TRAYS.

PRINT-FRAMES.

MADE OF HARDWOOD, WITH BRASS MOUNTINGS, CUSHION AND PLATE-GLASS.

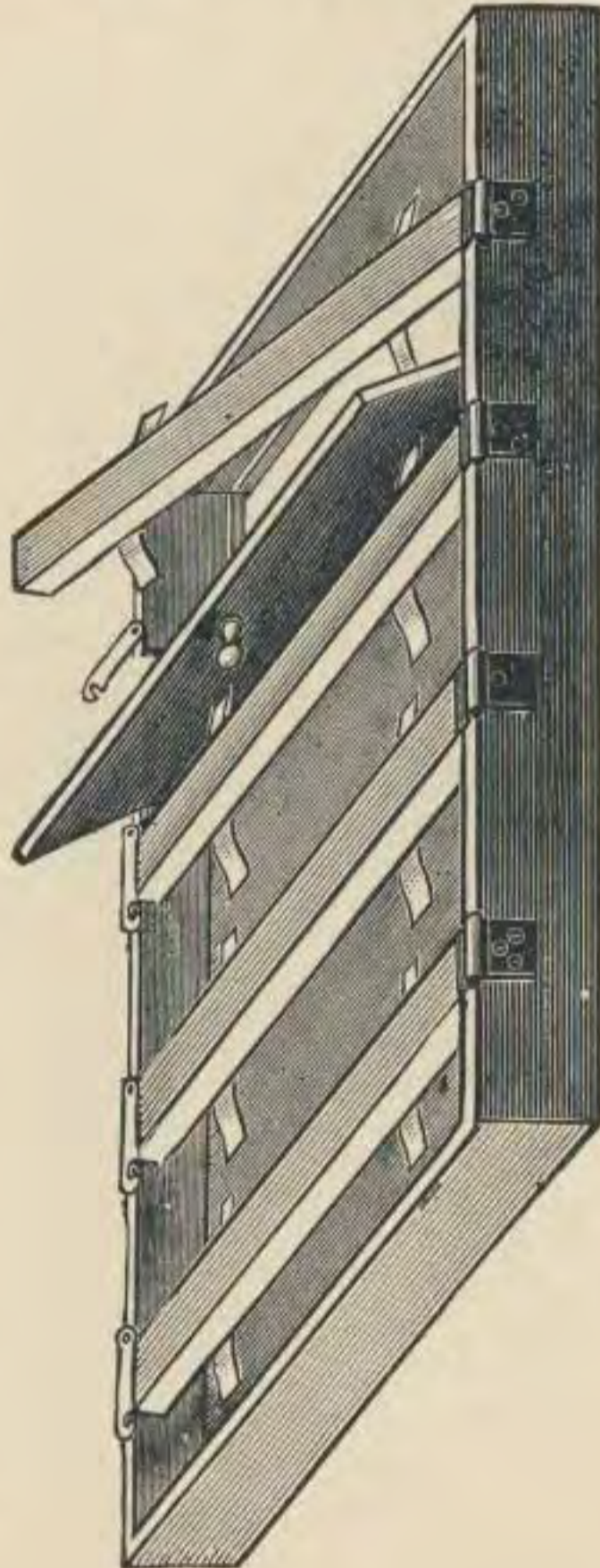

2534.

(For prices, see page 361.)

PRINT-FRAMES AND BATH-TRAYS

No.		PRICE.
2534.	Print-Frame, complete with Plate-Glass and Cushion, 24 x 20 inches, each.....	\$10.00
2536.	Print-Frame, complete with Plate-Glass and Cushion, 30 x 24 inches, each.....	12.00
2538.	Print-Frame, complete with Plate-Glass and Cushion, 42 x 30 inches, each.....	22.00
2540.	Zinc Bath-Tray, for Washing Copies, 24 x 20 inches, each.....	3.75
2542.	Zinc Bath-Tray, for Washing Copies, 30 x 24 inches, each.....	4.50
2544.	Zinc Bath-Tray, for Washing Copies, 42 x 30 inches, each.....	6.00

(See cut on page 360.)

THE BLUE PROCESS OF COPYING TRACINGS.

Special attention is directed to this easy process of copying tracings, and its great value to all Engineers, Architects and Mechanical Draftsmen is fully recognized.

If not convenient to procure a Print-Frame, blue-prints can be made readily by following these directions:—

1. Provide a flat board as large as the tracing which is to be copied.
2. Lay on this board a cushion of blanket or felt about $\frac{1}{4}$ -inch thick, to give a slightly yielding backing for the paper.
3. Lay on the blanket the prepared paper with the sensitive side uppermost.
4. Lay on this paper the tracing, smoothing it out as perfectly as possible, so as to insure a perfect contact with the paper.
5. Lay on the tracing a plate of clear glass, which should be heavy enough to press the tracing close down upon the paper. Ordinary plate-glass, one quarter of an inch in thickness, is sufficient.
6. Expose the whole to a clear sunlight by pushing it out on a shelf from a window, or in any other convenient way, from four to six minutes [in winter, six to ten minutes]. If a clear sky only can be had, the exposure must be continued from twenty to thirty minutes; and under a cloudy sky from sixty to ninety minutes may be needed, the shade depending on the time.
7. Remove the prepared paper and wash it freely for one or two minutes in clear water, and hang it by one corner to dry.

NOTE.—Too light a blue means under-exposure, and too dark a blue is over-exposure.

TIN TUBES WITH SCREW TOPS.

FOR HOLDING PREPARED PAPER, TRACINGS, DRAWINGS, ETC.

No.		PRICE.	POST.
2546.	Plain Tin Tube, screw top, 24 x 2 $\frac{1}{4}$ inches.....	\$1.00	\$0.30
2547.	Plain Tin Tube, screw top, 30 x 2 $\frac{1}{4}$ inches.....	1.15	.35
2548.	Plain Tin Tube, screw top, 36 x 2 $\frac{1}{4}$ inches.....	1.25	.40
2549.	Plain Tin Tube, screw top, 42 x 2 $\frac{1}{4}$ inches.....	1.35	.45

TOWNSHIP PLOTTING-PAPER.

2550.	Township Plotting-Paper, Rulings 6 x 6 inches, blocks 1 inch square, per quire.....	\$0.60	\$0.10
2552.	Township Plotting-Paper, Rulings 12 x 12 inches, blocks 2 inches square, per quire.....	.85	.25
2553.	Township Plotting-Paper, Rulings 18 x 15 inches, per quire	3.00	.30

CROSS-SECTION SKETCH-BLOCKS.

24 SHEETS.

2554.	Sketch-Block, 7 x 5 inches, 24 sheets, ruled $\frac{1}{10}$ of an inch.....	\$0.75	\$0.06
2555.	Sketch-Block, 10 x 7 inches, 24 sheets, ruled $\frac{1}{10}$ of an inch	1.25	.12
2557.	Sketch-Block, 18 x 13 cm., metric ruling.....	.75	.06
2558.	Sketch-Block, 26 x 18 cm., metric ruling.....	1.25	.12

PLAIN SKETCH-BLOCKS.

EACH BLOCK CONSISTS OF 32 SHEETS OF BEST QUALITY WHATMAN'S DRAWING-PAPER.

2560.	Sketch-Block, 7 x 5 inches, unbound.....	\$0.50	\$0.08
2561.	Sketch-Block, 10 x 7 inches, unbound.....	.90	.16
2563.	Sketch-Block, 14 x 10 inches, unbound.....	1.60	.40
2565.	Sketch-Block, 20 x 14 inches, unbound.....	3.00	.70
2570.	Sketch-Block, 7 x 5 inches, bound.....	1.00	.12
2571.	Sketch-Block, 10 x 7 inches, bound.....	1.50	.32
2573.	Sketch-Block, 14 x 10 inches, bound.....	2.40	.56
2575.	Sketch-Block, 20 x 14 inches, bound.....	4.50	

The unbound blocks have a stiff pasteboard backing.

The bound blocks have cloth sides and leather back, with a portfolio and loop for pencil inside. The portfolio will last for a number of blocks.

PROFILE - PAPERS.

(Prices on page 364.)

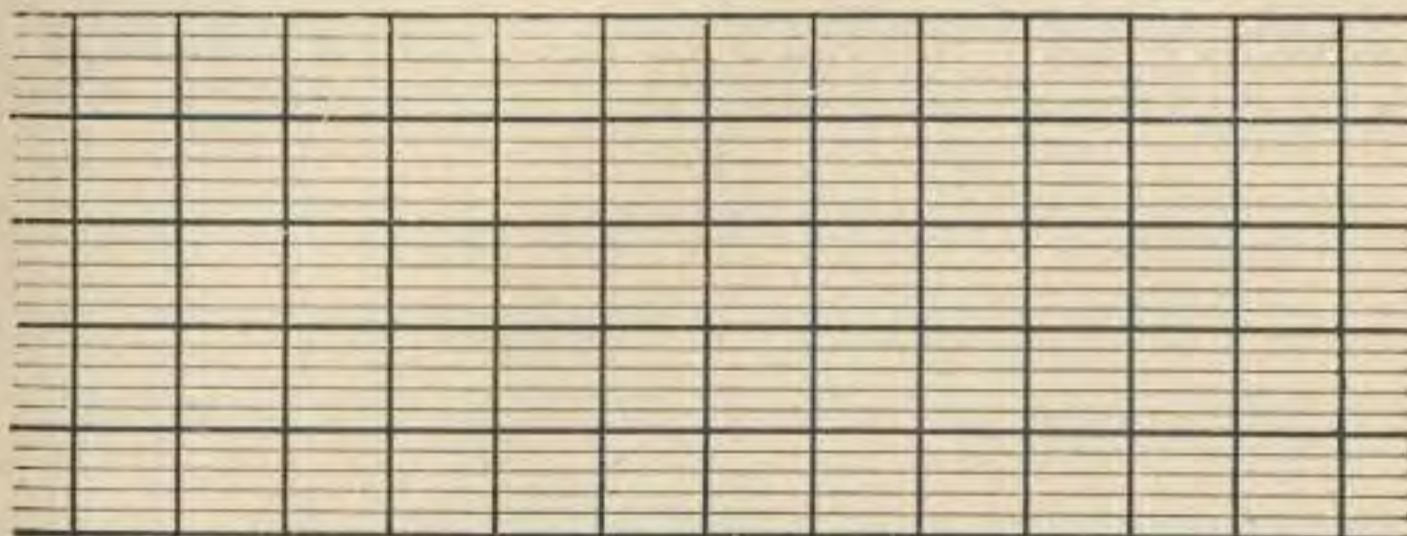

PROFILB-PAPER, PLATE A.



PROFILE-PAPER, PLATE B.

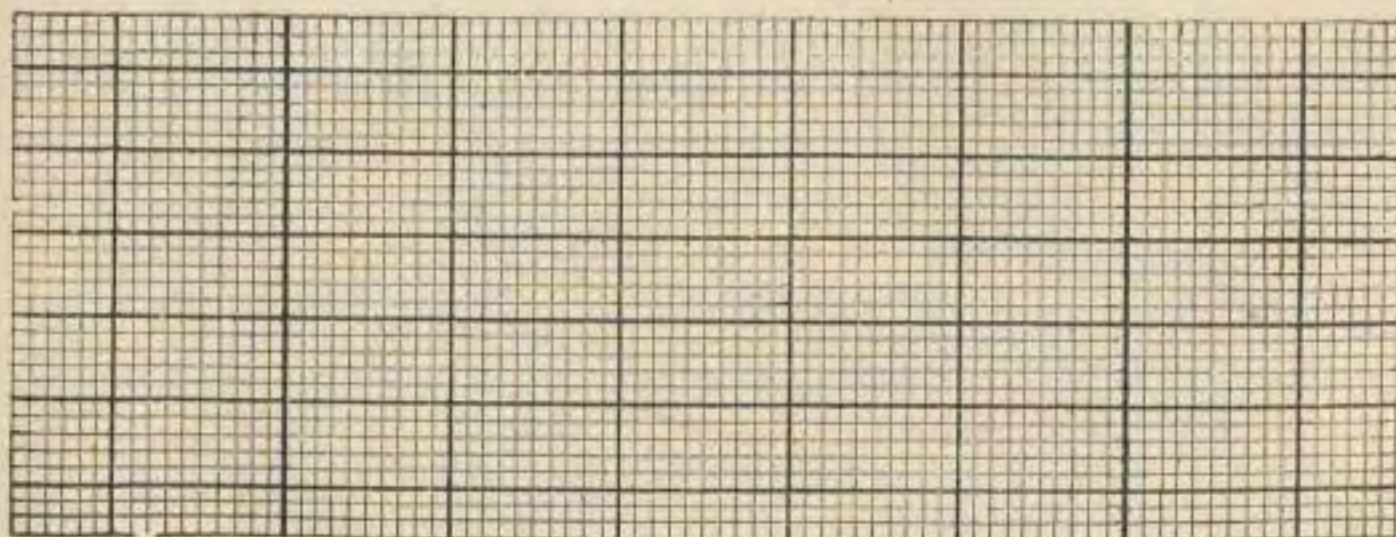

PROFILE-PAPER, METRIC.

PROFILE-PAPER.

Sheets : Lines printed in green.

Continuous : Lines printed in green or red.

Continuous on tracing-paper : Lines printed in orange.

PLATE A. Rulings 4 x 20 to the inch.

No.		PRICE.	POST.
2580.	Plate A, sheet 42 x 15 inches, per quire.....	\$8.50	\$0.75
2581.	Plate A, sheet 42 x 15 inches, per sheet.....	.40	.05
2584.	Plate A, continuous, 20 inches wide, 50 yards in roll, per yard.....	.24	.05
2586.	Plate A, continuous, 20 inches wide, mounted on muslin, 20 yards in roll, per yard.....	.65	.08
2588.	Plate A, continuous, 20 inches wide, on tracing-paper, 50 yards in roll, per yard.....	.24	.05

PLATE B. Rulings 4 x 30 to the inch.

2595.	Plate B, sheet 42 x 13½ inches, per quire.....	8.50	.75
2596.	Plate B, sheet 42 x 13½ inches, per sheet.....	.40	.05
2600.	Plate B, continuous, 20 inches wide, 50 yards in roll, per yard.....	.24	.05
2602.	Plate B, continuous, 20 inches wide, mounted on muslin, 20 yards in roll, per yard.....	.65	.08
2604.	Plate B, continuous, 20 inches wide, on tracing-paper, 50 yards in roll, per yard.....	.24	.05
2610.	METRIC.— In continuous roll, rulings 50 centimeters wide, in millimeters, with each fifth millimeter, each centimeter, and each decimeter, proportionally heavier than the millimeters, 50 yards in roll, per yard.....	.24	.05
2612.	Metric, continuous, mounted on muslin, 20 yards in roll, per yard.....	.65	.08

CROSS-SECTION PAPERS.

Sheets : Lines printed in green.

Continuous : Lines printed in green.

2620.	Cross-Section Paper, Plate C, rulings 20 x 16 inches, 8 feet to inch, per sheet, 20 cents ; per quire.....	\$3.50	\$0.40
2621.	Cross-Section Paper, Plate F, rulings 20 x 16 inches, 10 feet to inch, per sheet, 20 cents ; per quire.....	3.50	.40
2622.	Continuous Cross-Section Paper, Plate F, 20 inches wide, in rolls of 50 yards, per yard24	.05

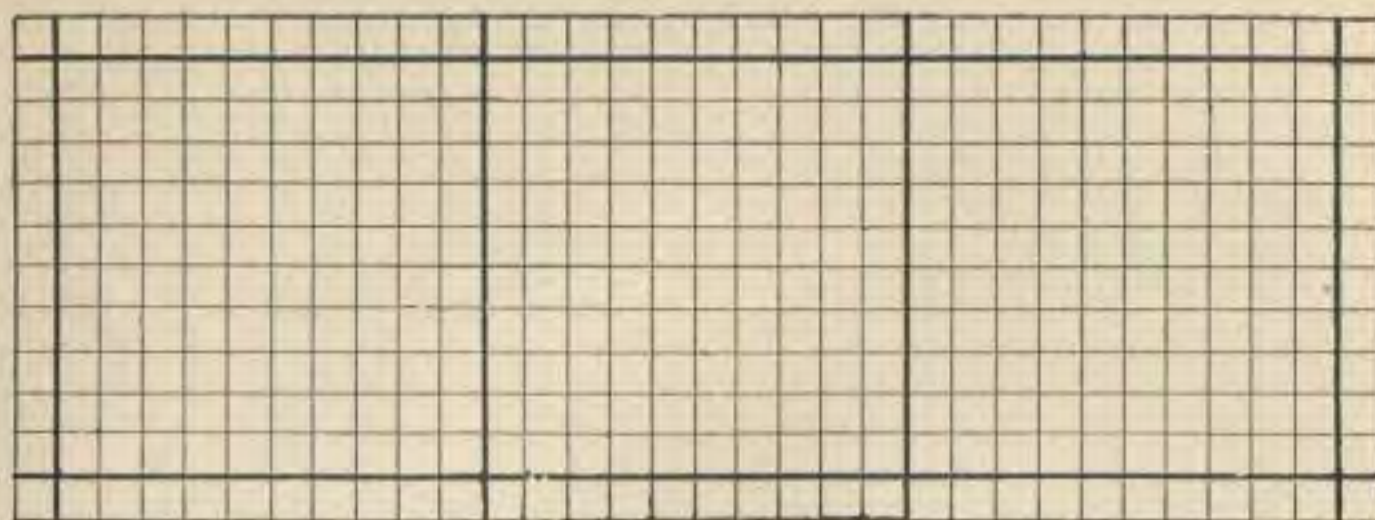

PLATE F. 10 feet to one inch.

No.		PRICE.	POST.
2623.	Continuous Cross-Section Paper, Plate F, 20 inches wide, ruled 10 feet to inch on tracing-paper, in rolls of 50 yards, per yard.....	\$0.24	\$0.05

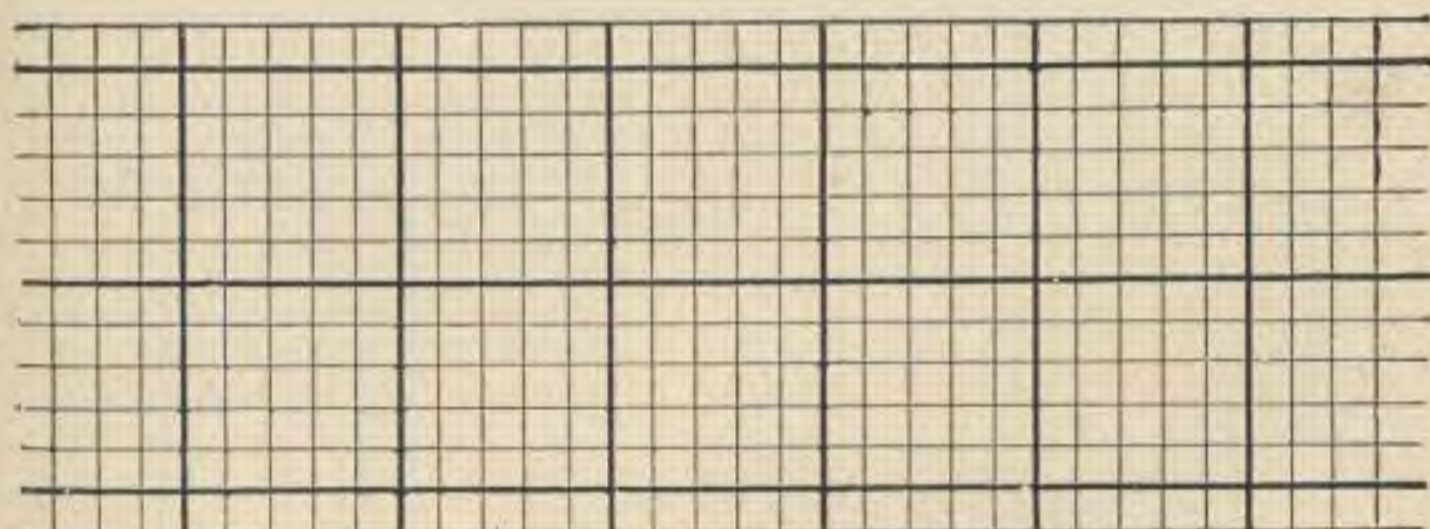
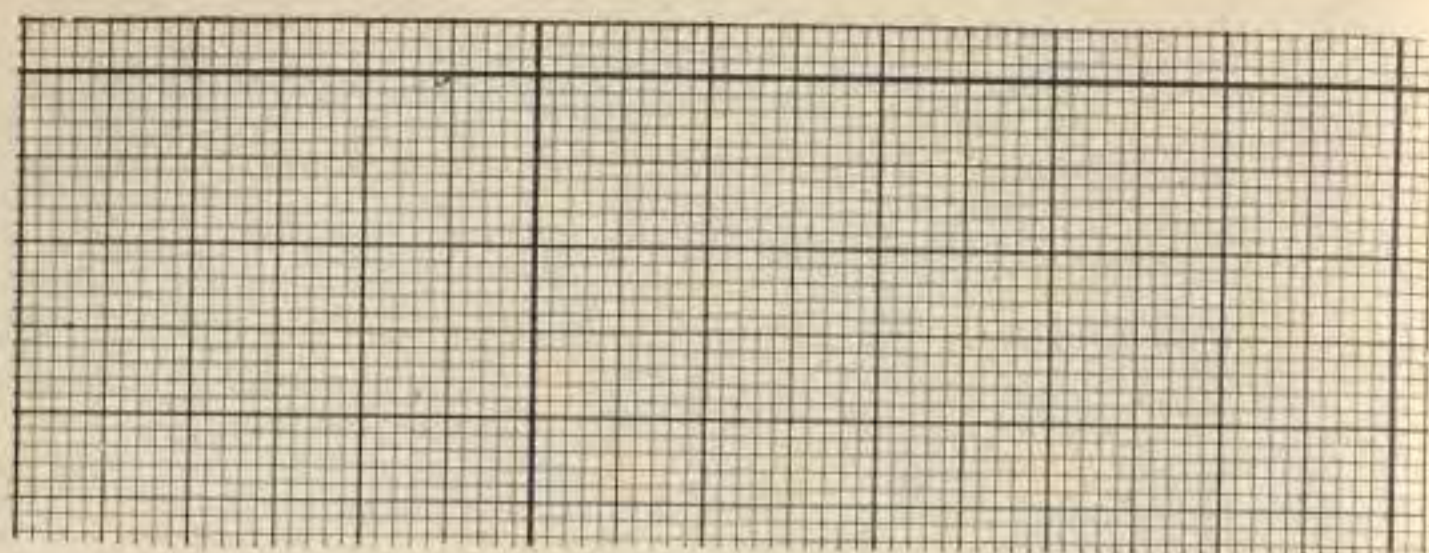

PLATE G.

2624.	Cross-Section Paper, Plate G, rulings 20 x 16 inches, 10 feet to inch, every fifth line heavy, per sheet, 20 cents; per quire	3.50	.40
2625.	Cross-Section, Plate G, printed on Parchment Tracing-Paper, in sheets, 20 x 16 inches, per sheet, 20 cents; per quire	3.50	.25
2626.	Cross-Section Paper, Plate H, rulings, 20 x 16 inches, 16 feet to inch, per sheet, 20 cents; per quire.....	3.50	.40
2627.	Continuous Cross-Section Paper, Plate H, 20 inches wide, in rolls of 50 yards, per yard.....	.24	.05
2630.	Cross-Section Paper, Metric, rulings every millimeter, size of sheet, 50 x 40 centimeters, per sheet, 20 cents; per quire.....	3.50	.40



MILLIMETER.

No.		PRICE.	POST.
2631.	Continuous Cross-Section Paper, Metric, rulings every millimeter, 50 centimeters wide, in rolls of 50 yards, per yard.....	\$0.24	\$0.05

The following list of Cross-Section Papers, being ruled, are much cheaper than those printed from copper plates :

2635.	Ruled Cross-Section Paper, 4 spaces to inch, 21 x 16 inches, per quire	1.00	.35
2636.	Ruled Cross-Section Paper, 8 spaces to inch, 21 x 16 inches, per quire	1.00	.35
2637.	Ruled Cross-Section Paper, 10 spaces to inch, 21 x 16 inches, per quire.....	1.00	.35
2638.	Ruled Cross-Section Paper, 12 spaces to inch, 21 x 16 inches, per quire.....	1.00	.35

WRITING-PAPER, ENVELOPES, ETC.

2660.	Commercial Note-Paper, 8 x 5 inches, fine, per ream, \$2.00 ; per quire.....	\$0.15	\$0.08
2662.	Letter-Paper, 10 x 8 inches, fine, per ream, \$3.50 ; per quire.....	.20	.12
2664.	Foolscap Paper, 12½ x 8 inches, fine, per ream, \$4.50 ; per quire.....	.30	.15
2665.	Specification Paper, 12½ x 8 inches, fine, per ream, \$5.00 ; per quire.....	.35	.15
2668.	Type-Writer Paper, 10½ x 8 inches, fine, per ream, \$1.50 ; per quire.....	.12	.05
2670.	Envelopes, white, 5⅞ x 3⅜ inches, fine, per hundred.....	.30	.15
2672.	Envelopes, white, 8⅞ x 3⅞ inches, fine, per hundred.....	.75	.20
2674.	Letter-Press Copying-Books, 500 pages, 12 x 10 inches.....	1.75	.28

No.		PRICE.	POST.
2675.	Stafford's Black Writing and Copying-Ink, quart bottle.....	\$1.00	
2676.	Arnold's Blue-Black Copying-Ink, quart bottle.....	1.00	
2678.	David's Carmine Ink, 2 oz. bottle.....	.35	\$0.08
2679.	Letter Copying-Press, No. 5, 15 x 10 inches, iron body, wheel handle.....	7.50	

Printed and Lithographed Stationery and all similar articles for office use furnished at reasonable rates.

THUMB-TACKS AND HORN CENTERS.



2680 TO 2690.

2708.

2680.	Brass Thumb-Tacks, round head, $\frac{1}{4}$ -inch diam., per doz.....	\$0.10	\$0.02
2681.	Brass Thumb-Tacks, round head, $\frac{3}{8}$ -inch diam., per doz.....	.20	.02
2682.	Brass Thumb-Tacks, round head, $\frac{1}{2}$ -inch diam., per doz.....	.30	.02
2684.	German Silver Thumb-Tacks, round head, $\frac{3}{8}$ -inch diam., per doz.....	.28	.02
2685.	German Silver Thumb-Tacks, round head, $\frac{1}{2}$ -inch diam., per doz.....	.35	.02
2686.	German Silver Thumb-Tacks, round head, $\frac{5}{8}$ -inch diam., per doz.....	.55	.03
2689.	German Silver Thumb-Tacks, round head, superior, $\frac{1}{2}$ -inch diam., per doz.....	.70	.02
2690.	German Silver Thumb-Tacks, round head, superior, $\frac{5}{8}$ -inch diam., per doz.....	.90	.03
2692.	Steel Thumb-Tacks, common, $\frac{3}{8}$ -inch diam., per doz.....	.08	.02
2694.	Steel Thumb-Tacks, common, $\frac{1}{16}$ -inch diam., per doz.....	.12	.02
2697.	Steel Thumb-Tacks, superior, $\frac{5}{16}$ -inch diam., per doz.....	.80	.02
2700.	Thumb-Tack Lifter and Paper-Knife.....	.20	.02
2703.	Brass Paper-Fasteners, prongs $\frac{5}{8}$ -inch, per doz.....	.08	.02
2705.	Brass Paper-Fasteners, prongs $\frac{5}{8}$ -inch, in box, per hundred.....	.50	.08
2707.	Horn Center, plain.....	.10	.01
2708.	Horn Center with German silver rim.....	.50	.01
2710.	Handy Paper-Cutter, brass mounted, for cutting drawings from the board.....	.35	.03

CONTINUOUS PROFILE-BOOKS.

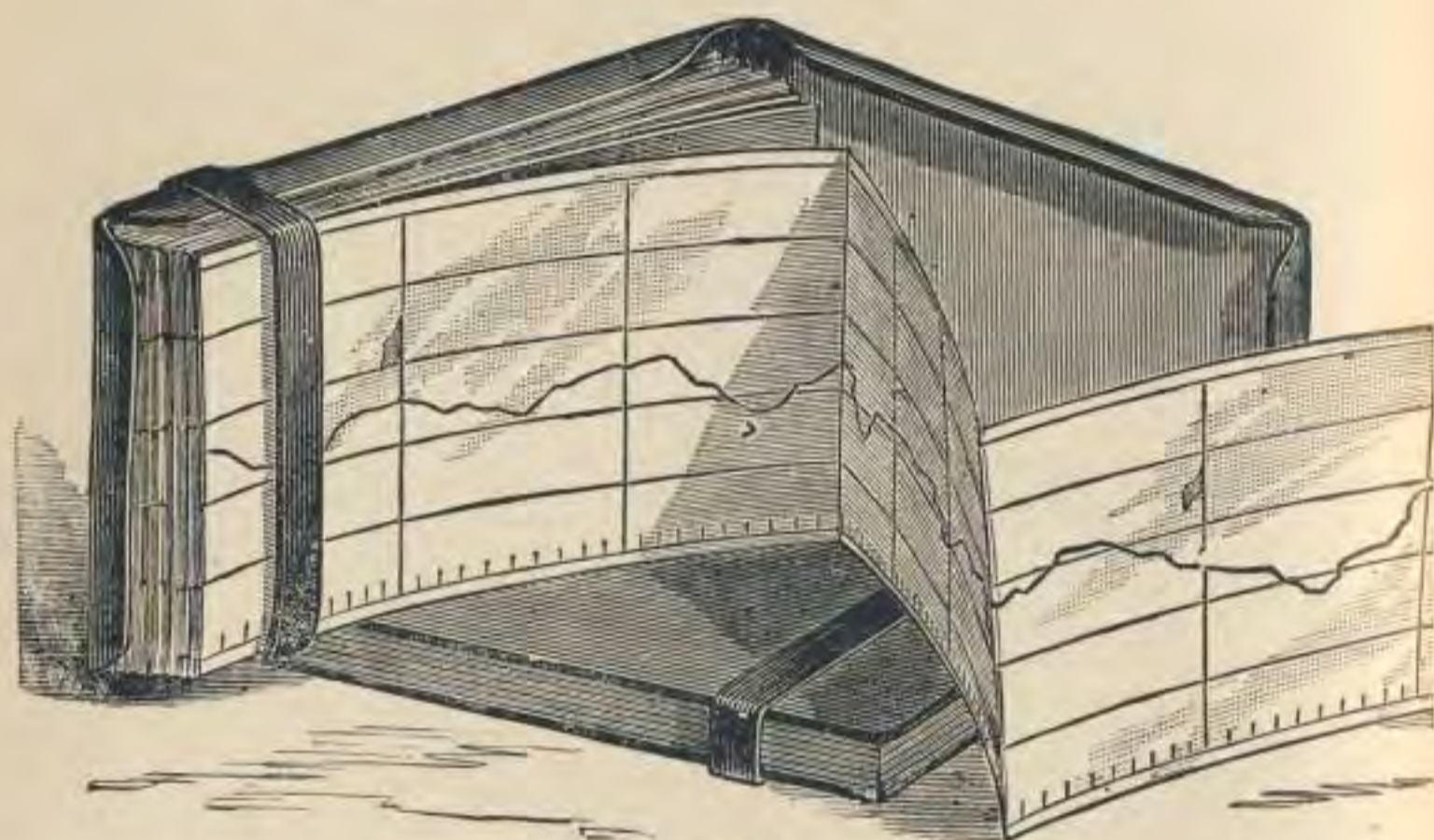

2715.

These books are for field or office purposes, being printed on a tough thick paper, and mounted upon a continuous piece of muslin and bound in book form with flexible morocco covers, convenient for the pocket. Each page will contain a profile of three thousand feet in length, so that each folio will contain an average section of a road as usually laid out for construction. Railroad and other engineers will find them very useful. The rulings correspond to our large profile-plates A and B.

No.		PRICE.	POST.
2715.	Plate A, 8 x 5 $\frac{1}{2}$ inches, profile 12 miles.....	\$2.00	\$0.15
2716.	Plate A, 8 x 5 $\frac{1}{2}$ inches, profile 25 miles.....	3.25	.18
2717.	Plate A, 8 x 5 $\frac{1}{2}$ inches, profile 50 miles.....	5.25	.20
2718.	Plate A, 8 x 5 $\frac{1}{2}$ inches, profile 100 miles.....	9.50	.28
2720.	Plate B, 8 x 4 $\frac{3}{4}$ inches, profile 12 miles.....	2.00	.13
2721.	Plate B, 8 x 4 $\frac{3}{4}$ inches, profile 25 miles.....	3.25	.15
2722.	Plate B, 8 x 4 $\frac{3}{4}$ inches, profile 50 miles.....	5.25	.18
2723.	Plate B, 8 x 4 $\frac{3}{4}$ inches, profile 100 miles.....	9.50	.25

ENGINEERS' BLANK FIELD-BOOKS.

LEATHER BINDING AND ROUNDED CORNERS.

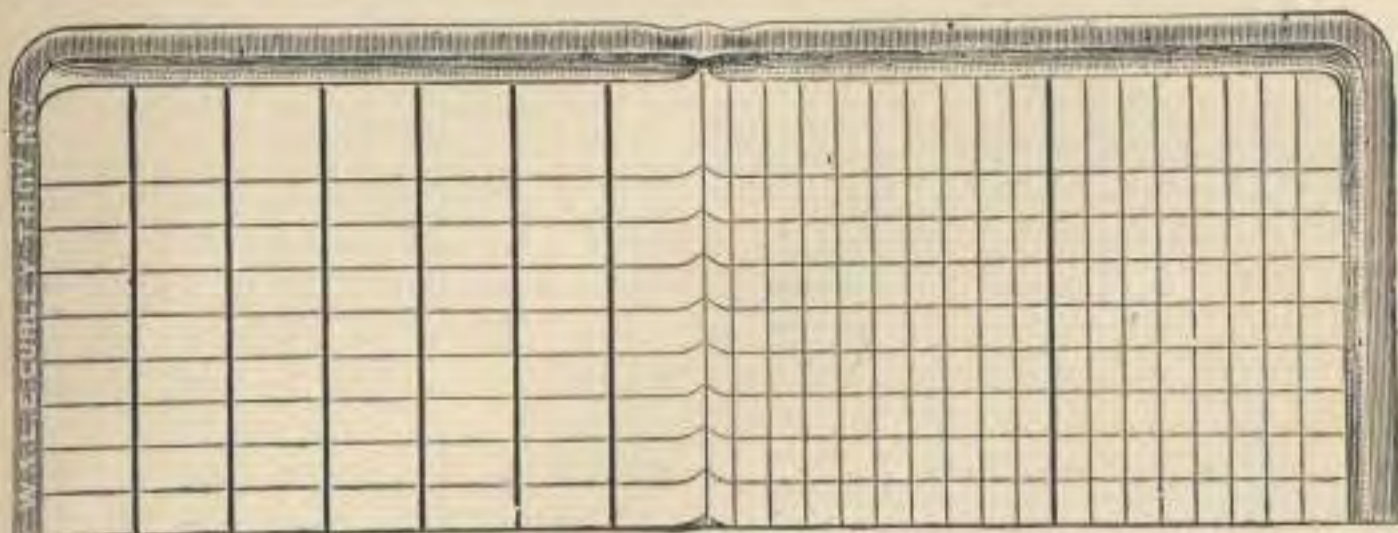

No.		PRICE.	POST.
2725.	Level-Books, 7 x 4 inches, 60 leaves, per dozen, \$5.00 ; or single.....	\$0.50	\$0.05



2728.	Transit-Books, 7 x 4 inches, 60 leaves, per dozen, \$5.00 ; or single.....	.50	.05
-------	---	-----	-----

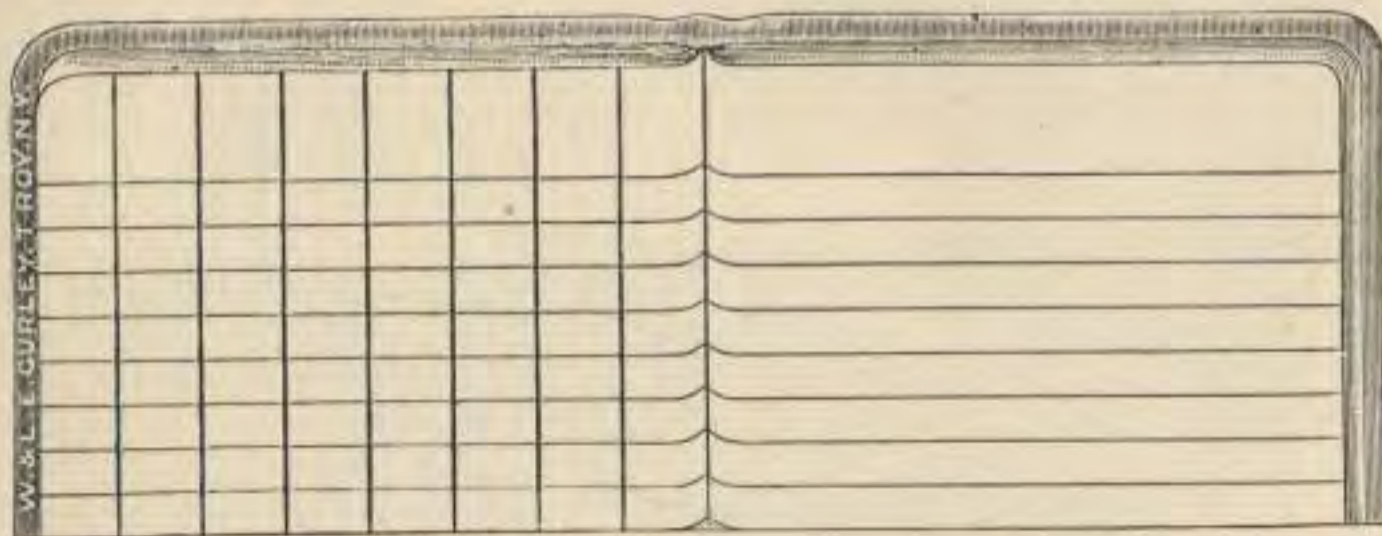

2731.	Record-Books, 7 x 4 inches, 60 leaves, per dozen, \$5.00 ; or single.....	.50	.05
-------	--	-----	-----

BLANK FIELD-BOOKS.—*Continued.*

No.		PRICE.	POST.
2734.	Profile Level-Books, 7 x 4 inches, 80 leaves, the right-hand page ruled like profile-paper; per dozen, \$7.50; or single.....	\$0.75	\$0.05
2736.	Cross-Section Books, 7 x 4 inches, 60 leaves, ruled 5 spaces per inch, per dozen \$5.00; or single.....	.50	.05
2738.	Cross-Section Books, 7 x 4 inches, 60 leaves, ruled 10 spaces per inch, per dozen, \$5.00; or single..	.50	.05
2740.	Cross-Section Books, 8 x 7 inches, 80 leaves, ruled 5 spaces per inch, per dozen 10.00; or single.....	1.00	.15
2742.	Cross-Section Books, 8 x 7 inches, 80 leaves, ruled 10 spaces per inch, per dozen, \$10.00; or single..	1.00	.15

LYONS' TABLES.

2746. Lyons' Tables. A set of tables for finding at a glance the true cubical contents of Excavation and Embankment for all Bases, and for every variety of Ground and Side Slopes. By E. M. Lyons, C. E.

Sheet No. 5.	Base 15 feet, Slopes.....	$\frac{1}{4}$ to 1
Sheet No. 6.	Base 15 feet, Slopes.....	1 to 1
Sheet No. 7.	Base 15 feet, Slopes.....	$1\frac{1}{2}$ to 1
Sheet No. 8.	Base 16 feet, Slopes.....	$\frac{1}{4}$ to 1
Sheet No. 15.	Base 24 feet, Slopes.....	$\frac{1}{4}$ to 1
Sheet No. 16.	Base 24 feet, Slopes.....	$1\frac{1}{2}$ to 1
Sheet No. 17.	Base 25 feet, Slopes.....	$1\frac{1}{2}$ to 1
Sheet No. 18.	Base 26 feet, Slopes.....	$1\frac{1}{2}$ to 1
Sheet No. 19.	Base 28 feet, Slopes.....	$\frac{1}{4}$ to 1
Sheet No. 20.	Base 30 feet, Slopes.....	1 to 1
Sheet No. 21.	Base 30 feet, Slopes.....	$1\frac{1}{4}$ to 1
Sheet No. 22.	Base 30 feet, Slopes.....	$1\frac{1}{2}$ to 1
Sheet No. 23.	Base 32 feet, Slopes.....	1 to 1
Sheet No. 24.	Base 32 feet, Slopes.....	$1\frac{1}{2}$ to 1
Per sheet.....		15 cents; post, 5 cents.

The Tables are printed in clear, bold type, on tinted paper, sheets 25 x 16 inches. They may be used by candle-light without injuring the eye-sight. Each sheet is complete in itself, and embraces all that is wanted in connection with Base or Slope designated, whether on level or side-hill cross-section.

Tables Nos. 1, 2, 3, 4, 9, 10, 11, 12, 13, and 14, quoted in our previous catalogues, are now out of print.

LEAD-PENCILS. (Black Leads.)

No.		PRICE.	POST.
2750.	Faber's Hexagon, Siberian, best Drawing, Nos. 2 B to 8 H, per dozen.....	\$1.25	\$0.12
2752.	Faber's Hexagon, Drawing, Nos. 1 to 5, per dozen..	.75	.04
2754.	Faber's Round, Drawing, Nos. 1 to 4, per dozen....	.60	.04
2756.	Faber's Round, No. 4, small, for Drawing-Compasses, per dozen.....	.60	.02
2758.	Faber's Round, Nos. 2 and 3, with rubber tip, for offices, per dozen.....	.50	.04
2765.	Faber's Artists' Pencil, with movable lead, H to 6 H, each.....	.25	.02
2768.	Faber's Siberian Leads, H to 6 H, for Artists' Pencil, 6 in box, per box.....	.50	.04
	These leads fit the pencil legs of modern Drawing-Compasses.		
2770.	Faber's Siberian Round Pencils, 5 in box, 2 B to H, per box.....	.50	.04
2771.	Faber's Siberian Round Pencils, 7 in box, 3 B to 2 H, per box.....	.65	.05
2772.	Faber's Siberian Round Pencils, 10 in box, 4 B to 4 H, per box.....	.90	.08
2774.	Faber's Siberian Round Pencils, 5 in box, with knife and rubber, per box.....	.75	.05
2778.	Hardtmuth's Koh-i-noor Pencils, Hexagon, Superfine, H to 8 H, per dozen.....	1.25	.12

COLORED PENCILS AND CRAYONS.

2785.	Faber's Round, Red, Blue, Green and Yellow Pencils, per dozen.....	\$0.75	\$0.05
2790.	Faber's Round, Wax Crayon Pencils, 6 in box, assorted colors, per box.....	.75	.05
2791.	Faber's Round, Wax Crayon Pencils, 12 in box, assorted colors, per box.....	1.40	.15
2793.	Faber's Flat Red Chalk Pencils, for marking stakes, per dozen.....	.50	.05



2795.

(See page 372.)

No.		PRICE.	POST.
2795.	Venetian Crayons, dark red, for marking stakes, per dozen	\$0.60	\$0.15
2796.	Venetian Crayons, dark blue, for marking stakes, per dozen60	.15
2797.	Hexagon Lumber Crayons, red, blue or black, per dozen.....	.75	.15

These crayons are superior quality and do not soil the hands.

STEEL LETTERING AND WRITING-PENS.

2800.	Gillott's Mapping-Pens, per dozen.....	\$0.60	\$0.02
2801.	Gillott's Lithographic Pens, per dozen.. ..	.60	.02
2802.	Gillott's Crow Quill Pens, per dozen.....	.60	.02
2806.	Gillott's Writing-Pens, No. 170, per dozen, 10 cents; per gross.....	1.05	.10
2807.	Gillott's Writing-Pens, No. 303, per dozen, 15 cents; per gross.....	1.40	.10
2810.	Falcon Writing-Pens, No. 048, per dozen, 10 cents; per gross75	.04
2812.	Spencerian Writing-Pens, per dozen, 15 cents; per gross.....	1.25	.10
2814.	Commercial Writing-Pens, per dozen, 10 cents; per gross.....	.75	.04
2816.	Penholders, black handle, nickel tip, for office use, per dozen.....	.50	.05

ROUND-WRITING PENS, FOR ORNAMENTAL LETTERING.



2820.



2824.

2820.	Pens, single pointed, Nos. 1 to 6, assorted, per dozen	\$0.12	\$0.02
2822.	Pens, single pointed, Nos. 1 to 6, assorted, per gross,	1.00	.15
2824.	Pens, double pointed, Nos. 10, 20 and 30, assorted, per dozen ..	.35	.03
2826.	Sample assortment of 25 Pens, per box.....	.35	.04
2828.	Penholders for round-writing pens, each.....	.10	.02
2830.	Text-Book to round-writing with full instructions....	.65	.05
2831.	Copy-Book for round-writing practice.....	.35	.05

STEEL ERASING-KNIVES AND PENCIL-SHARPENERS.

No.		PRICE.	POST.
2835.	Steel Blade Eraser, Cocoa handle	\$0.35	\$0.03
2836.	Steel Blade Eraser, Ivory handle.....	.50	.03
2838.	Steel Eraser, long knife-blade, Cocoa handle.....	.50	.03



2840.

2840.	Faber's New Pencil-Sharpener (superior)25	.03
2842.	Common Pencil-Sharpener.....	.10	.02
2843.	Fine Steel Pencil-File, with sheath.....	.25	.03
2844.	Fine Steel Pencil-File, with Tack-lifter at end.....	.25	.03

ERASING RUBBER.



2850.



2862.



2866.

2850.	Faber's Artists' Rubber, $1\frac{3}{8}$ x 1 inch, each.....	\$0.05	\$0.01
2852.	Faber's Artists' Rubber, $1\frac{3}{4}$ x $1\frac{1}{4}$ inches, each.....	.10	.02
2854.	Faber's Artists' Rubber, 2 x $1\frac{3}{8}$ inches, each.....	.15	.03
2856.	Faber's Artists' Rubber, $2\frac{1}{4}$ x $1\frac{1}{2}$ inches, each.....	.25	.03

No.		PRICE.	POST.
2860.	Faber's Artists' Rubber, black, pure gum, $2 \times 1\frac{3}{8}$ inches, each.....	\$0.20	\$0.03
2862.	Faber's Ink-Eraser, $1\frac{1}{2} \times 1$ inch, each.....	.05	.01
2864.	Faber's Ink-Eraser, $2\frac{3}{8} \times 1\frac{1}{2}$ inches, each.....	.20	.03
2866.	Faber's Combined Ink and Pencil-Eraser, $2\frac{1}{4} \times 1$ inch, each.....	.15	.02
2867.	Faber's Combined Ink and Pencil-Eraser, $2\frac{1}{2} \times 1\frac{3}{8}$ inches, each.....	.25	.03
2868.	Faber's Typewriters' Rubber, $3\frac{1}{4} \times \frac{5}{8}$ inch, each.....	.10	.02



2870.

2870.	Faber's Pointed Rubber, $2\frac{1}{2} \times \frac{5}{16}$ inch, each.....	.09	.01
2871.	Faber's Pointed Rubber, $3 \times \frac{3}{8}$ inch, each.....	.12	.01



2872.

2872.	Davidson's Velvet Rubber, oblong, $1\frac{5}{8} \times \frac{1}{2}$ inch, each.....	.05	.01
2874.	Davidson's Velvet Rubber, oblong, $2\frac{1}{4} \times \frac{9}{16}$ inch, each.....	.10	.02
2876.	Davidson's Velvet Rubber, oblong, $3\frac{1}{4} \times \frac{5}{8}$ inch, each.....	.20	.03
2878.	Davidson's Velvet Rubber, oblong, $3 \times 2\frac{1}{4} \times \frac{9}{16}$ inch, each.....	.50	.06



2880.

No.		PRICE.	Post.
2880.	Satin Finish Rubber, oblong, $2\frac{3}{4} \times \frac{3}{8}$ inch, each.....	\$0.05	\$0.01
2882.	Satin Finish Rubber, oblong, $3 \times \frac{1}{4}$ inch, each.....	.10	.02
2884.	Satin Finish Rubber, oblong, $3\frac{1}{4} \times \frac{1}{4}$ inch, each.....	.15	.03
2886.	Satin Finish Rubber, oblong, $3\frac{3}{4} \times \frac{1}{4}$ inch, each.....	.25	.04



2890.

2890.	Multiplex Rubber, superior quality, $2 \times \frac{1}{2}$ inch, each..	.10	.02
2891.	Multiplex Rubber, superior quality, $2\frac{1}{2} \times \frac{5}{8}$ inch, each	.15	.02
2892.	Multiplex Rubber, superior quality, $2\frac{3}{4} \times \frac{3}{4}$ inch, each	.25	.03
2893.	Multiplex Rubber, superior quality, $2\frac{3}{4} \times 1\frac{1}{8}$ inches, each37	.04



2896.

2896.	Sponge Rubber, for cleaning drawings, $2 \times 2 \times 1$ inch.....	.30	.03
2898.	Sponge Rubber, for cleaning drawings, $4 \times 2 \times 1$ inch.....	.60	.06

RUBBER BANDS.

2900.	Rubber Bands, No. 8, $\frac{7}{8} \times \frac{1}{16}$ inch, per gross.....	\$0.15	\$0.02
2902.	Rubber Bands, No. 29, $1\frac{1}{2} \times \frac{1}{8}$ inch, per gross.....	.65	.05
2904.	Rubber Bands, No. 61, $2 \times \frac{1}{4}$ inch, per gross.....	1.00	.15
2905.	Rubber Bands, No. 63, $3 \times \frac{1}{4}$ inch, per gross.....	1.50	.20
2907.	Rubber Bands, No. 200, 11 sizes assorted, $1\frac{1}{8}$ to 3 inches, per box.....	1.00	.18

HIGGINS' DRAWING-BOARD AND LIBRARY MUCILAGE.

No.		PRICE.	POST.
2915.	Drawing-Board Mucilage, fine quality, 3-ounce jar..	\$0.15	\$0.13
2916.	Drawing-Board Mucilage, fine quality, 6-ounce jar..	.25	.20
2917.	Drawing-Board Mucilage, fine quality, 14-ounce jar	.50	.30
2918.	Taurine Mucilage, fine quality, 2-ounce bottle with brush10	.10
2919.	Taurine Mucilage, fine quality, 4-ounce bottle with brush20	.15
2920.	Taurine Mucilage, fine quality, pint bottle without brush50	.30
2921.	Taurine Mucilage, fine quality, quart bottle without brush80	
2923.	Photo-Mounter, fine quality, 3-ounce jar.....	.15	.13
2924.	Photo-Mounter, fine quality, 6-ounce jar.....	.25	.20



2915.



2925.

HIGGINS' AMERICAN LIQUID DRAWING-INKS.

No.		PRICE.
2925.	Waterproof Black Ink, small bottle.....	\$0.25
2926.	Waterproof Black Ink, 8-oz. bottle.....	2.00
2928.	General Black Ink (not waterproof), small bottle.....	.25
2929.	General Black Ink (not waterproof), 8-oz. bottle.....	2.00

No.	PRICE.	No.	PRICE.
2930.	Waterproof Carmine...\$0.25	2935.	Waterproof Violet....\$0.25
2931.	Waterproof Scarlet.... .25	2936.	Waterproof Green.... .25
2932.	Waterproof Vermilion .25	2937.	Waterproof Yellow25
2933.	Waterproof Blue..... .25	2938.	Waterproof Brown..... .25
2934.	Waterproof Indigo25	2939.	Waterproof Orange25
2942.	Waterproof Ink, any of the above colors, per large (8-oz.) bottle.....		2.00

Postage on the above inks, 7 cents each small bottle, and 30 cents each 8-oz. bottle.

WINSOR & NEWTON'S WATER-COLOR LIQUIDS.

IN GLASS BOTTLES.

No.	PRICE.	No.	PRICE.
2945.	Indian Ink, Black... \$0.30	2950.	Silver Ink..... \$0.30
2946.	Chinese White..... .30	2951.	Gold Ink..... .30
2947.	Carmine30	2952.	Indelible Brown30
2948.	Sepia..... .30	2953.	Prout's Brown30
2949.	Prussian Blue..... .30	2954.	Extract of Ox Gall... .30

Postage on the above inks, 6 cents each bottle.

MISCELLANEOUS LIQUID DRAWING-INKS.

No.	PRICE.	POST.
2956.	Bourgeois Black India Ink, per bottle.....	\$0.25 \$0.06
2957.	Photo-Drawing Ink, Dead Black, per bottle.....	.20 .06
2958.	Box of Indelible Drawing-Inks, six bottles (Blue, Brown, Carmine, Green, Scarlet, Yellow), per box	1.50 .35
2959.	Winsor & Newton's Waterproof Drawing-Inks (Black, Brown, Carmine, Emerald Green, In- digo, Vermilion, Yellow), per bottle.....	.25 .06

CHINESE INDIA INK FOR GENERAL DRAWING.



2968.

No.		PRICE.	Post.
2960.	Oval, Black, Lion Head, $3\frac{1}{4}$ inches, per cake.....	\$0.35	\$0.02
2962.	Round, Black, Lion Head, $2\frac{1}{2}$ inches, per cake.....	.25	.02
2963.	Round, Black, Lion Head, $4\frac{1}{4}$ inches, per cake.....	.65	.04
2965.	Hexagon, Black, Lion Head, $3 \times \frac{5}{8}$ inch, per cake..	.50	.03
2967.	Square, Black, Super Super, $3 \times \frac{1}{2}$ inch, per cake....	.50	.03
2968.	Square, Black, Super Super, $3\frac{3}{4} \times \frac{5}{8}$ inch, per cake...	1.00	.12
2970.	Oblong, Black, Double Dragon, fine, $3\frac{5}{8} \times \frac{7}{8}$ inch, per cake.....	2.00	.12
2971.	Oblong, Dead Black, for Photo-Drawing, $3\frac{1}{2} \times \frac{7}{8}$ inch, per cake.....	1.00	.12
2972.	Oblong, Red Ink, fine, $2\frac{3}{4}$ inches, per cake.....	.75	.03
2973.	Oblong, Blue Ink, fine, $2\frac{3}{4}$ inches, per cake.....	.75	.03
2974.	Oblong, Yellow Ink, fine, $2\frac{3}{4}$ inches, per cake.....	.75	.03

JAPANESE INDIA INK.

For drawings in which the ink-lines are washed in applying colors.



2980.

No.		PRICE.	Post.
2980.	Oblong, black, fine quality, $3\frac{3}{4}$ inches, small cake...	\$1.00	\$0.12
2982.	Oblong, black, fine quality, $3\frac{3}{4}$ inches, medium cake	2.00	.13
2984.	Oblong, black, fine quality, $3\frac{3}{4}$ inches, large cake...	3.00	.14

WINSOR & NEWTON'S WATER-COLORS.

MOIST IN CHINA PANS, OR HARD COLORS IN CAKES.

(The moist colors are usually preferred, as they do not waste by crumbling.)



WHOLE CAKE.



HALF CAKE.



WHOLE PAN.



HALF PAN.

No. 2990. Whole, each, 25 cts.; Half, each, 15 cts.

- | | | |
|----------------------|---------------------------|---------------------|
| 1. Antwerp Blue. | *14. Dragon's Blood. | 30. Olive Green. |
| 2. Bistre. | 15. Emerald Green. | 31. Orange Chrome. |
| 3. Blue Black. | *16. Flake White. | 32. Payne's Gray. |
| * 4. British Ink. | 17. Gamboge. | 33. Prussian Blue. |
| * 5. Bronze. | 18. Hooker's Green No. 1. | 34. Prussian Green. |
| 6. Brown Ochre. | 19. Hooker's Green No. 2. | 35. Raw Sienna. |
| 7. Brown Pink. | 20. Indian Red. | 36. Raw Umber. |
| 8. Burnt Sienna. | 21. Indigo. | 37. Roman Ochre. |
| 9. Burnt Umber. | 22. Italian Pink. | 38. Sap Green. |
| 94. Charcoal Gray. | 23. Ivory Black. | 39. Terre Verte. |
| 10. Chinese White. | *24. King's Yellow. | 40. Vandyke Brown. |
| 95. Chrome Lemon. | 25. Lamp Black. | 41. Venetian Red. |
| 11. Chrome Yellow. | 26. Light Red. | 42. Vermilion. |
| 12. Cologne Earth. | 27. Naples Yellow. | 43. Yellow Lake. |
| *48. Constant White. | 28. Neutral Tint. | 44. Yellow Ochre. |
| 13. Deep Chrome. | 29. New Blue. | |

2992. Whole, each, 45 cts.; Half, each, 25 cts.

- | | | |
|--------------------|-----------------------|------------------------|
| *45. Black Lead. | 50. Mars Yellow. | 54. Reuben's Madder. |
| 46. Brown Madder. | 51. Neutral Orange. | 55. Scarlet Lake. |
| 47. Cerulean Blue. | 62. Orange Vermilion. | 56. Scarlet Vermilion. |
| 49. Crimson Lake. | 52. Purple Lake. | 57. Sepia. |
| 60. Indian Yellow. | 53. Roman Sepia. | 58. Warm Sepia. |

No.

2994. Whole, each, 65 cts.; Half, each, 35 cts.

67. Cadmium Orange.	72. French Blue.	74. Green Oxide of Chromium.
68. Cadmium Yellow, Pale.	75. Indian Purple.	98. Permanent Mauve
69. Cadmium Yellow.	76. Intense Blue.	99. Permanent Violet.
59. Cobalt Blue.	61. Lemon Yellow.	79. Pure Scarlet.
97. Cobalt Green.	77. Mars Orange.	63. Violet Carmine.

2996. Whole, each, 90 cts.; Half, each, 45 cts.

65. Aureolin.	71. Field's Orange-Vermilion.	82. Purple Madder.
91. Aurora Yellow.	81. Madder Carmine.	80. Rose Madder.
66. Burnt Carmine.	78. Pink Madder.	90. Scarlet Madder.
70. Carmine.	92. Primrose Aureolin.	93. Yellow Carmine.

2998. Whole, each, \$1.40; Half, each, 70 cts.

83. Smalt.	84. Ultramarine Ash.
------------	----------------------

Colors marked * are not made in pans.

Postage on water colors, 1 cent each.

The following colors are generally used by Architects and Civil and Mechanical Engineers :

- Burnt Umber to represent earth.
- Burnt Sienna to represent wood.
- Light Red to represent brick.
- Sepia and Yellow Ochre to represent stone.
- Prussian Blue to represent wrought iron.
- Payne's Gray to represent cast iron.
- Gamboge to represent brass.
- Gamboge and Carmine to represent copper.
- Prussian Blue and Carmine to represent steel.

In Topography the following colors are generally used :

- Hooker's Green No. 2 to represent grass.
- Burnt Sienna to represent cultivated ground.
- Burnt Sienna and Hooker's Green to represent uncultivated ground.
- Indigo and Hooker's Green to represent swamp.
- Gamboge and Hooker's Green to represent trees.
- Yellow Ochre to represent roads and streets.
- Indigo to represent water.
- Carmine to represent buildings, bridges and masonry.
- Sepia to represent hills.
- Sepia to represent shade lines and shadows.

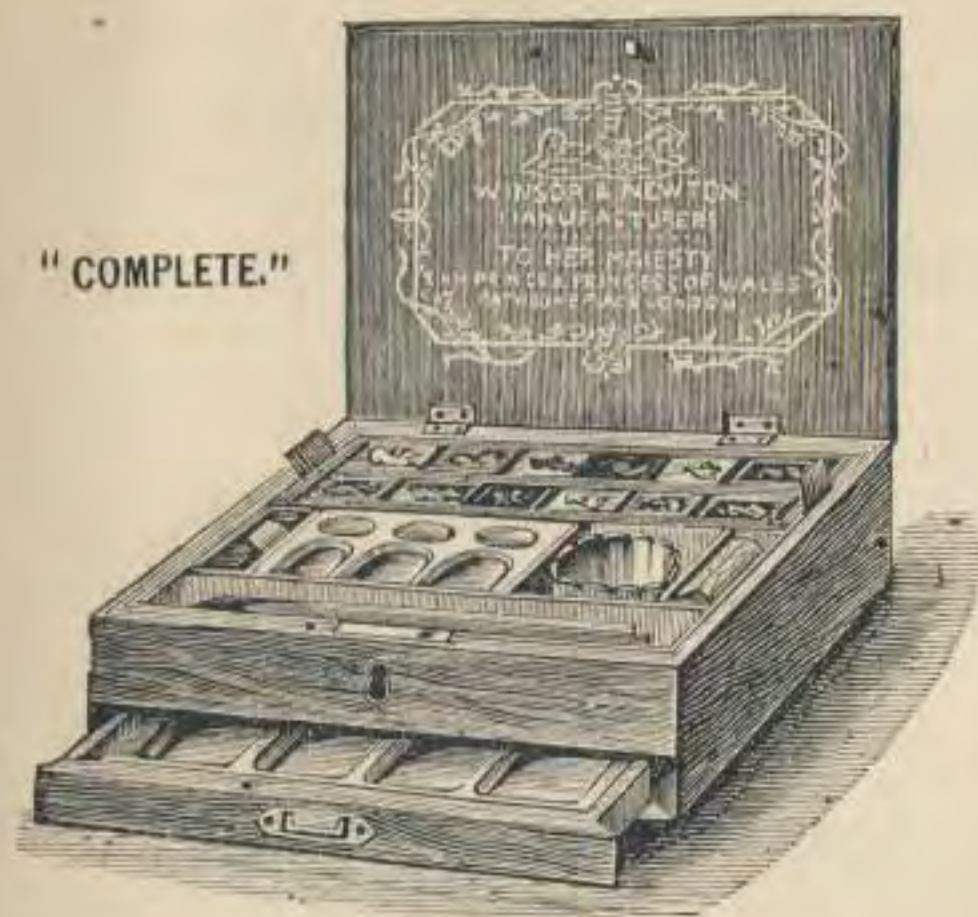

3000.



3010.

WINSOR & NEWTON'S WATER-COLORS.

IN POLISHED MAHOGANY BOX, WITH LOCK AND KEY, AND DRAWER, PAINT-STONE, WATER-GLASS, INDIA INK, BRUSHES AND COLORS.

No.		PRICE.	POST.
3000.	Complete Box, with 12 colors, whole cakes.....	\$9.00	\$1.00
3002.	Complete Box, with 18 colors, whole cakes.....	13.50	1.15
3004.	Complete Box, with 12 colors, half cakes.....	6.00	.50
3006.	Complete Box, with 18 colors, half cakes.....	7.75	.65

EMPTY JAPANED TIN COLOR-BOXES.

3010.	Japanned Box, to hold 6 whole or 12 half pans....	\$0.80	\$0.06
3011.	Japanned Box, to hold 9 whole or 18 half pans....	1.00	.15
3012.	Japanned Box, to hold 12 whole or 24 half pans....	1.15	.20
3014.	Japanned Box, to hold 18 whole or 36 half pans....	1.40	.26

EMPTY WOOD SLIDE-LID COLOR-BOXES.

3015.	Color-Box to hold 6 whole or half cakes.....	\$0.40	\$0.04
3016.	Color-Box to hold 12 whole or half cakes.....	.50	.08
3017.	Color-Box to hold 18 whole or half cakes.....	.60	.12

WATER-COLOR BRUSHES.

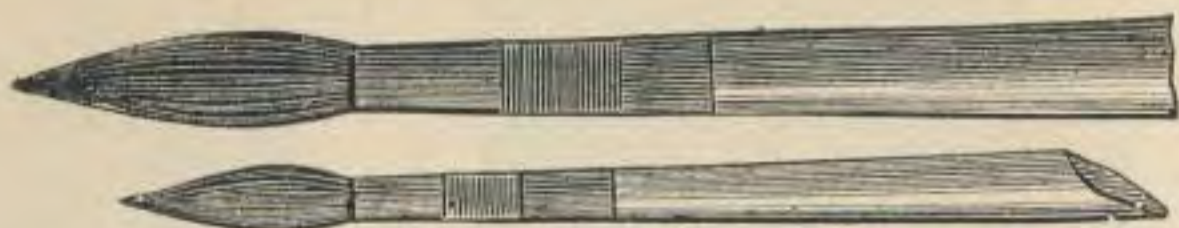

3. 6.
3020
AND
3025.

No. 3020. Camel Hair in Quills :

	No. 1.	2.	3.	4.	5.	6.	7.	8.	Post.
Each,	\$0.05	.05	.06	.06	.08	.08	.10	.10	\$0.01

3025. Red Sable in Quills :

	No. 1.	2.	3.	4.	5.	6.	7.	8.	Post.
Each,	\$0.10	.12	.15	.20	.25	.33	.45	.60	\$0.01



6.
3030.
4.

3030. Camel Hair in Tin, with handle :

	No. 1.	2.	3.	4.	5.	6.	Post.
Each,	\$0.10	.10	.12	.12	.15	.15	\$0.02



4.
3035.
3.

3035. Red Sable, in Albata, with handle :

	No. 1.	2.	3.	4.	5.	6.	7.	13.	14.	Post.
Each,	\$0.20	.25	.35	.45	.55	.65	.75	1.00	1.30	\$0.02 to \$0.10



3040.

3040. Camel Hair Sky or Wash Brush, in Tin, with Handle :

	No. 0.	1.	2.	3.	4.	Post.
Each,	\$0.18	.20	.25	.35	.45	\$0.02



3045.

3045. Camel Hair Wash Brushes in Tin, with two points :

	No. 0.	1.	2.	3.	Post.
Each,	\$0.35	.40	.50	.65	\$0.02

WATER-GLASSES, INK AND COLOR-SLABS.



3050.

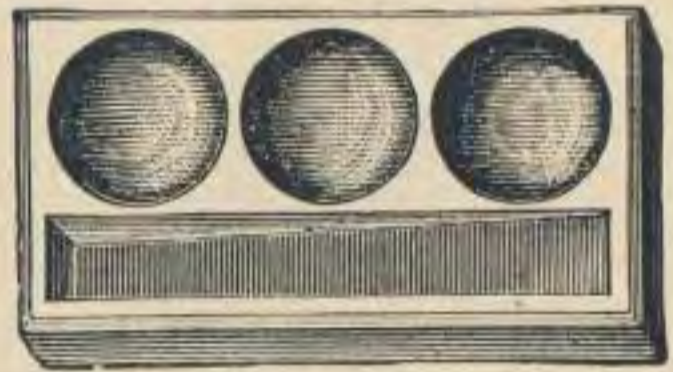

3054.

No.		PRICE.	POST.
3050.	Artist's Water-Glass, $2\frac{3}{8}$ inches, each.....	\$0.12	\$0.08
3051.	Artist's Water-Glass, $3\frac{1}{4}$ inches, each.....	.25	.10
3054.	Ink or Color-Slab, $2\frac{3}{4}$ x $1\frac{1}{2}$ inches, each.....	.10	.05
3055.	Ink or Color-Slab, $3\frac{1}{2}$ x $2\frac{1}{4}$ inches, each.....	.15	.07
3056.	Ink or Color-Slab, 4 x $2\frac{1}{2}$ inches, each.....	.25	.10
3057.	Ink or Color-Slab, $4\frac{3}{8}$ x $2\frac{3}{4}$ inches, each.....	.30	.15
3065.	Slate Ink-Slab, $3\frac{1}{2}$ x $3\frac{1}{2}$ inches, with glass cover, each	.35	.15
3067.	Opal Glass Ink-Saucer, with cover, $\frac{3}{4}$ -inch, each...	.50	.15

PATENT INK-SLAB.



3070.

3070.	Patent Ink-Slab, China, with cover, $4\frac{1}{2}$ x $1\frac{3}{4}$ inches, each	\$0.35	\$0.12
3071.	Patent Ink-Slab, China, with cover, $5\frac{1}{4}$ x $2\frac{1}{8}$ inches, each40	.16

COLOR-SAUCERS.

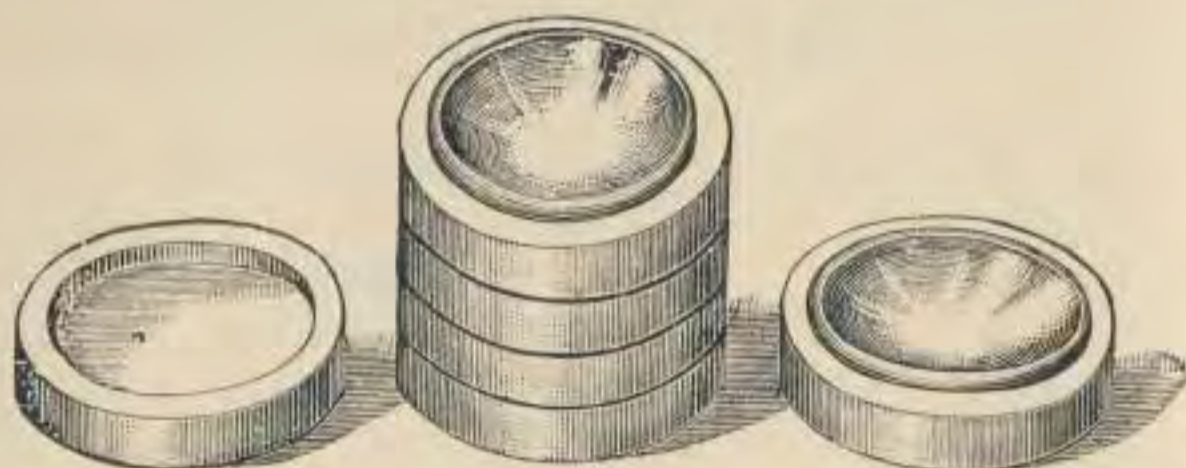

3075.

No.		PRICE.	POST.
3075.	Nest of 5 Saucers and a cover, $2\frac{3}{8}$ inches, per nest...	\$0.45	\$0.15
3076.	Nest of 5 Saucers and a cover, $2\frac{5}{8}$ inches, per nest...	.55	.20
3077.	Nest of 5 Saucers and a cover, $3\frac{1}{4}$ inches, per nest...	.65	.28
3078.	Nest of 5 Saucers and a cover, $3\frac{3}{4}$ inches, per nest...	.75	.35

BRASS STENCILS. ALPHABETS AND FIGURES.

No.	Height of Letters	$\frac{1}{4}$ in.	$\frac{3}{8}$ in.	$\frac{1}{2}$ in.	$\frac{5}{8}$ in.	$\frac{3}{4}$ in.	1 in.
3100.	Stencil-Alphabet.....	\$1.00	\$1.15	\$1.30	\$1.50	\$1.75	\$2.00
3101.	Stencil-Alphabet.....	1.85	2.00	2.15	2.30	2.50	2.75
3102.	Stencil-Alphabet.....	4.00	4.15	4.30	4.50	4.75	5.00
3103.	Stencil-Alphabet.....	1.85	2.00	2.15	2.30	2.50	2.75

A set of Figures to match any of these Alphabets will cost one-third the price of the same style and size of Alphabet.

Postage on each Alphabet.....	\$0.14
Postage on each set of Figures, Nos. 3100, 3101 and 3103..	.04
Postage on each set of Figures, No. 3102.....	.12

BRASS STENCIL-PLATES.

	PRICE.	POST.
3110. North Point, full size.....	\$0.50	\$0.02
3111. North Point, full size.....	.75	.02
3112. North Point, full size.....	.60	.02
3115. Ornamental Corner, full size.....	1.00	.10
3116. Ornamental Corner, full size.....	.75	.03
3120. Dasher, full size.....	.25	.02
3121. Dasher, full size.....	.25	.02

A Stencil-Brush is furnished with each Alphabet or set of Figures without extra charge.

Use thick India ink for marking.

Other styles and sizes of Alphabets, Figures and Stencil-Plates made to order.

STENCIL-PLATES.

EMMA A43

3100.

3101.

3102.

3103.

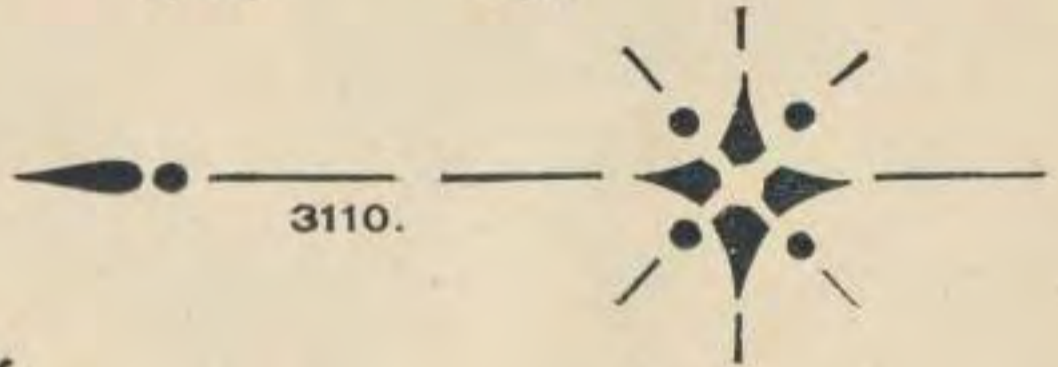

3110.

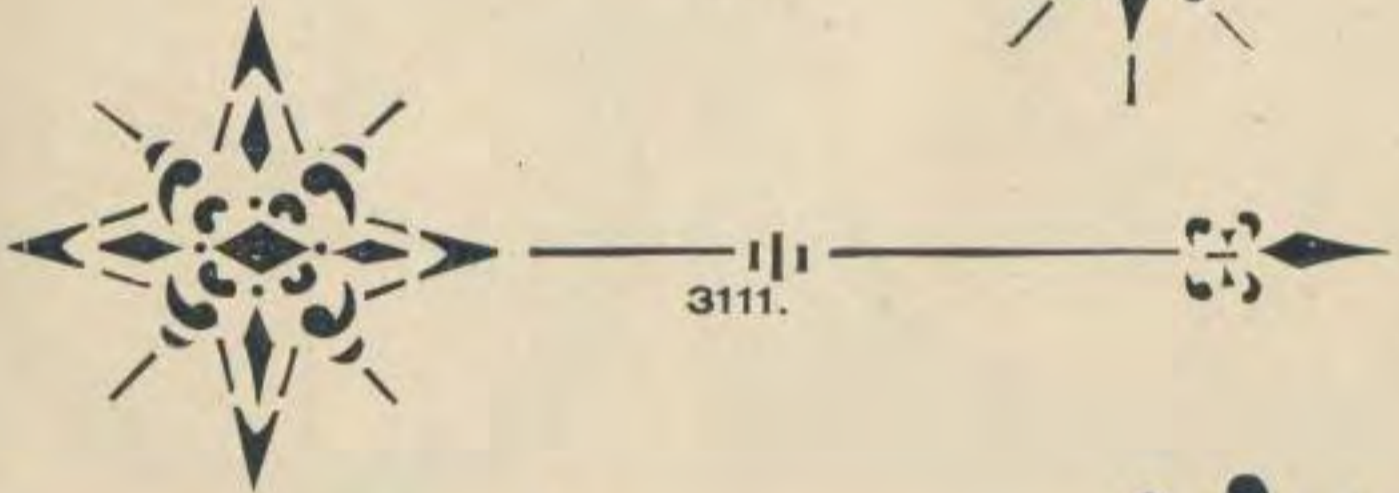

3111.

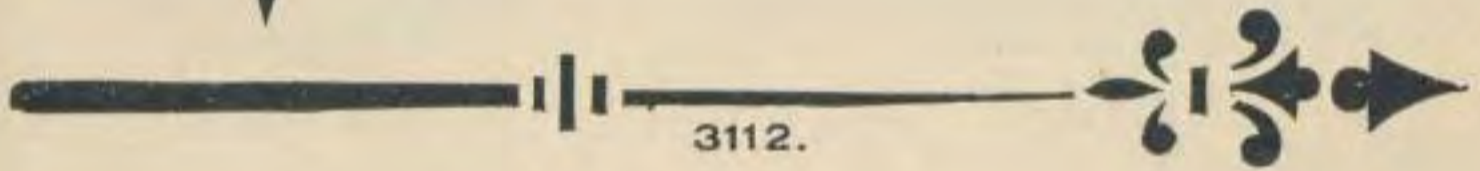

3112.



3115.

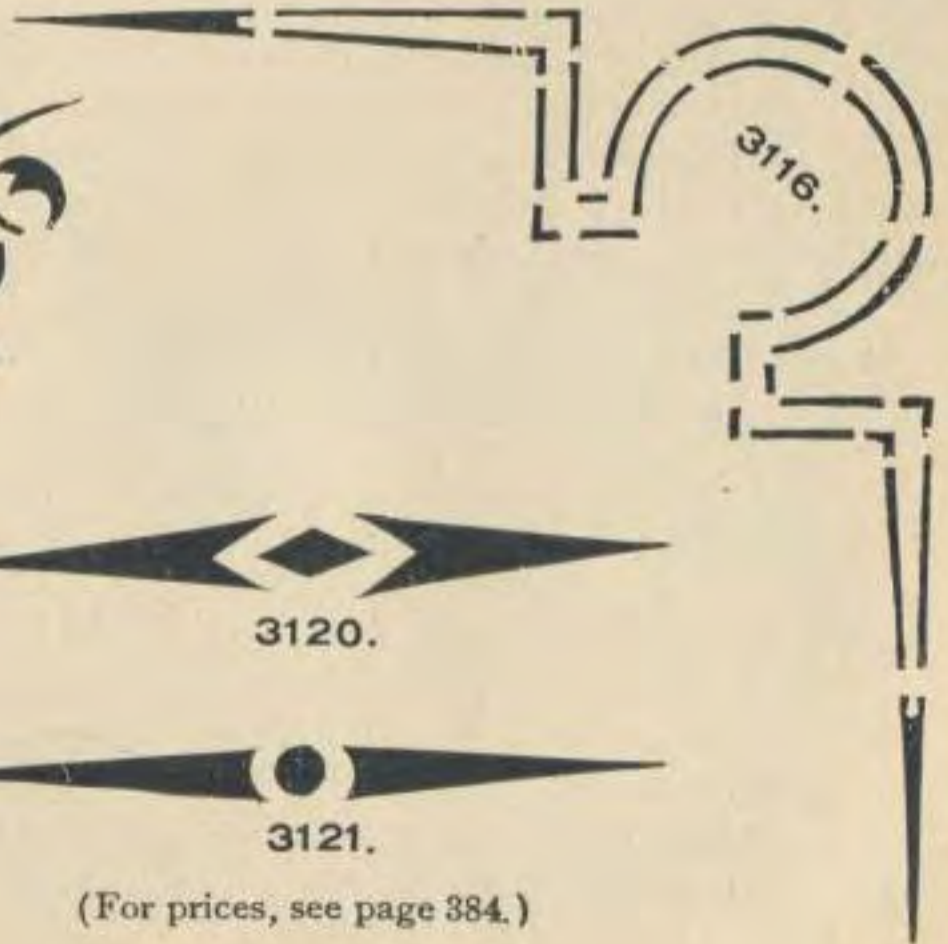

3116.

3120.

3121.

(For prices, see page 384.)

COMMON POCKET-COMPASSSES.

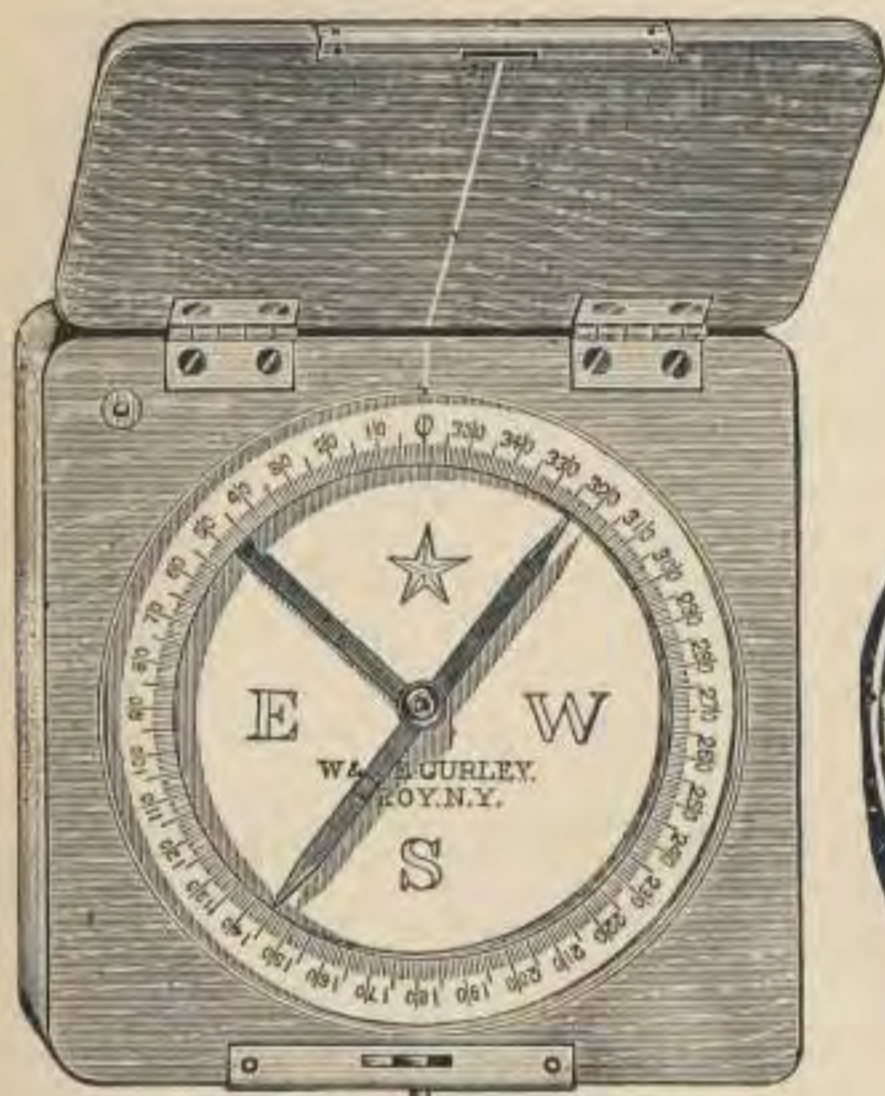

3154.



3160.

No.		PRICE.	POST.
3150.	Mahogany case, stop to needle, 2 inches square.....	\$2.00	\$0.12
3152.	Mahogany case, stop to needle, 3 inches square.....	2.50	.15
3154.	Government pattern, mahogany case, 3 inches square, raised ring, superior needle with stop, Gurley, maker	3.50	.15
3160.	Brass, round, watch pattern, stop, agate center, 1½ inches diameter.....	.85	.04
3161.	Brass, round, watch pattern, stop, agate center, 2 inches diameter.....	1.00	.12
3164.	Brass, round, stop, agate center, 1½ inches diameter, with cover.....	1.10	.12
3165.	Brass, round, stop, agate center, 2 inches diameter, with cover.....	1.25	.12
3166.	Brass, round, stop, agate center, 2½ inches diameter, with cover, (superior).....	2.50	.14
3168.	Brass, round, watch pattern, stop, agate center, 1½ inches diameter, with hinged cover.....	1.25	.12
3170.	Brass, round, watch pattern, stop, agate center, 2 inches diameter, with hinged cover.....	1.50	.12

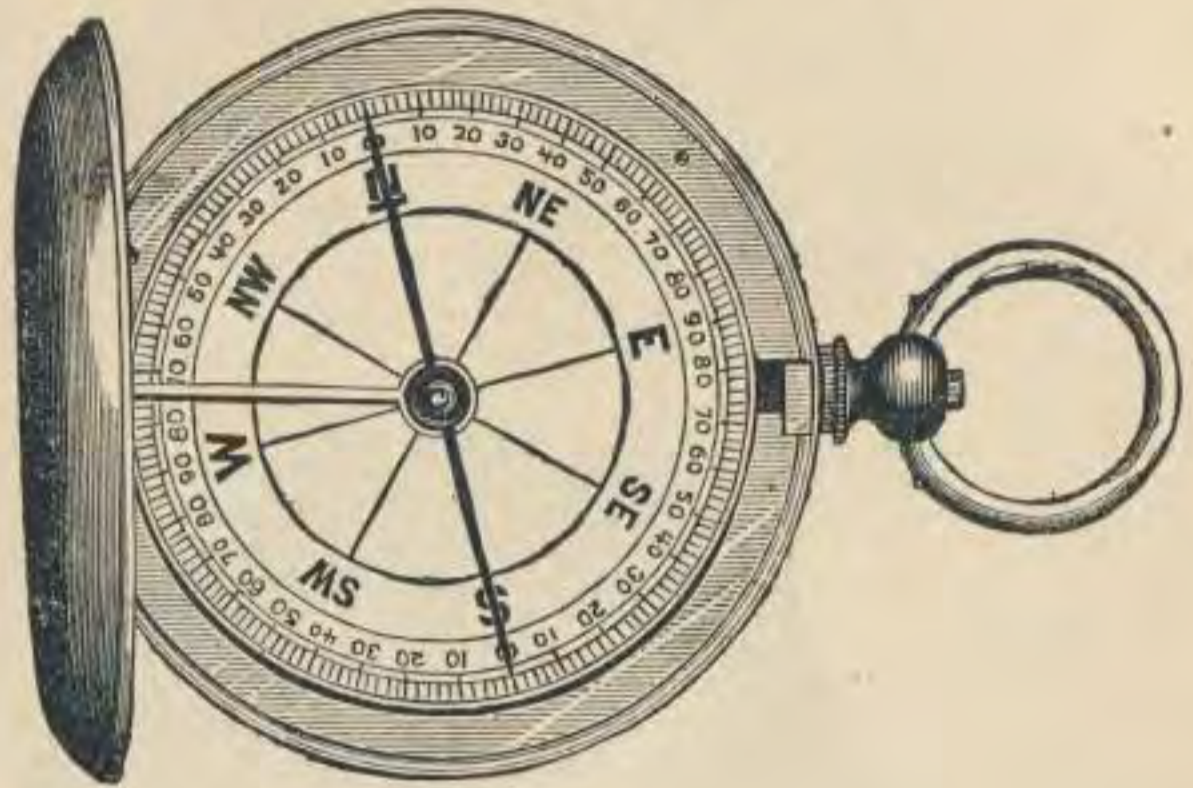

3175.

No.		PRICE.	POST.
3175.	Pocket-Compass, 2 inches diameter, hunting-case, spring catch, stop to needle in joint of cover, and bar needle with agate center.....	\$3.50	\$0.12
3176.	Pocket-Compass, 2½ inches diameter, hunting-case, spring catch, stop to needle in joint of cover, and bar needle with agate center.....	4.50	.12



3178.

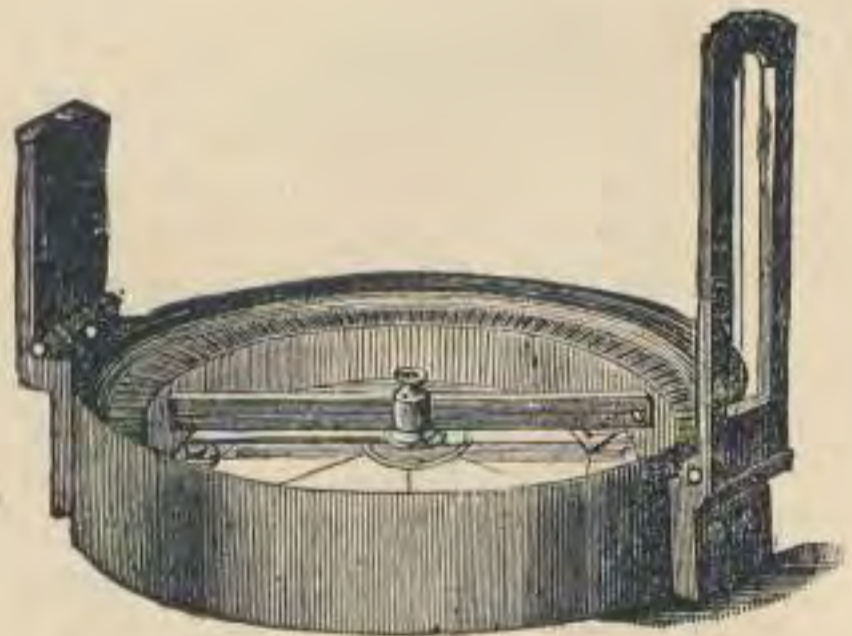

3182.

3178.	Pocket-Compass, 1½ inches diameter, watch pattern, gilt, stem stop, bar needle.....	4.00	.12
3179.	Pocket-Compass, 2½ inches diameter, watch pattern, gilt, stem stop, bar needle.....	4.50	.12

No.		PRICE.	POST.
3182.	Pocket-Compass, 2½ inches diameter, with cover, folding sights, bar needle with agate center and stop to needle.....	\$5.50	\$0.14
3183.	Pocket-Compass, 3 inches diameter, with cover, folding sights, bar needle with agate center and stop to needle.....	6.50	.16

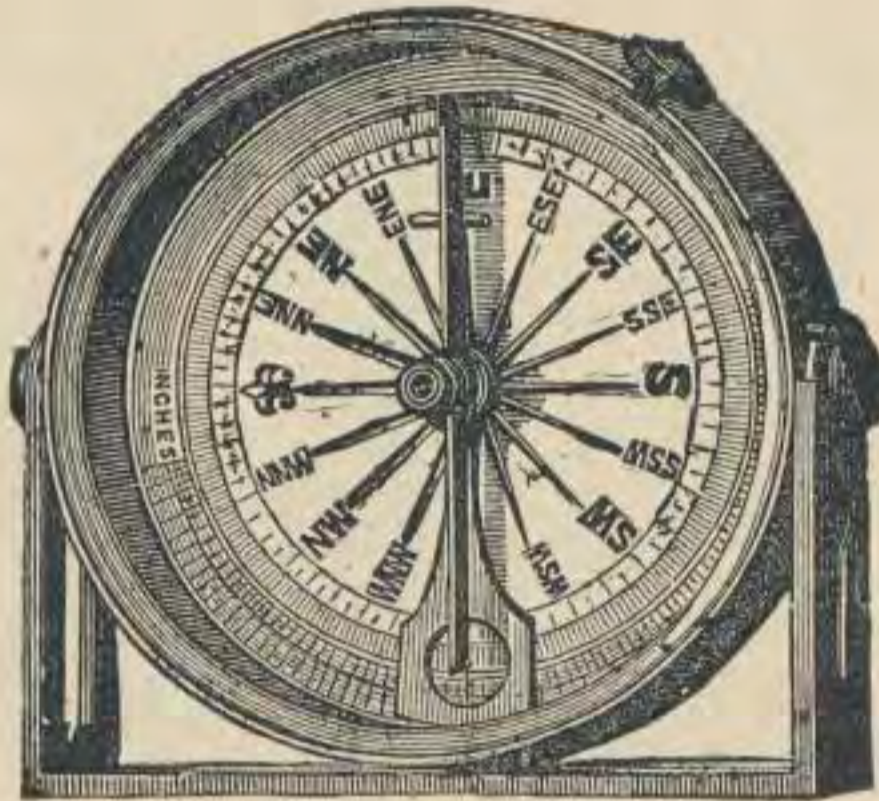

3186. As Clinometer.

3186.	Clinometer Compass, 2½ inches diameter, graduated to one-degree, bar needle with agate center and stop, pivoted sights to swing over compass-face, cover and morocco case.....	7.25	.15
3187.	Clinometer Compass, 3 inches diameter, graduated to one degree, bar needle with agate center and stop, pivoted sights, cover and morocco case.....	8.75	.18
3188.	Pocket-Compass, 3⅝ inches diameter, heavy brass case and cover, 2½-inch needle with agate center and stop, superior, Gurley, maker.....	6.00	.20
3192.	Pocket-Compass, 1¾ inches diameter, watch pattern, stem stop, Singer's patent pearl dial.....	3.85	.12
3194.	Geological Compass, 2½ inches, with pendulum, for ascertaining the angle of dip in rocks.....	4.25	.15
3196.	Gilt Charm Compasses to hang to watch guard.....	PRICE. \$0.25 to \$2.00	POST. \$0.02 to \$0.10
3200.	Pocket-Compass, watch pattern, 2½ inches diameter, hunting-case, raised ring, agate center, stop to needle, folding sights.....	5.00	.15

No.		PRICE.	POST.
3220.	Pocket Alt-Azimuth, with Telescope, for travelers and military surveyors. Altitudes, azimuths, compass bearings, clinometer degrees and levels are all obtained by this instrument. Size $6\frac{1}{2} \times 2\frac{1}{2} \times 1\frac{1}{8}$ inches, in case.....	\$50.00	\$0.40

PRISMATIC COMPASSES.



3225.

No.		PRICE.	POST.
3225.	Prismatic Compass, $2\frac{1}{8}$ inches diameter, hunting-case ; can be used as an ordinary compass without opening the cover, and a prismatic compass by raising the cover, glazed with a stout glass, on which is etched a line for the sight. With folding prism and floating card dial with stop	\$15.00	\$0.15
3226.	Prismatic Compass, $3\frac{3}{8}$ inches diameter, with floating metal dial, azimuth glasses, folding prism, folding sight with hinged mirror, ball-joint and staff socket, in morocco case.....	21.50	.25
3227.	Prismatic Compass, 3 inches diameter, with floating card dial graduated to $\frac{1}{2}$ degrees, folding prism and folding sight, with metal cover, in leather sling case.....	16.00	.20

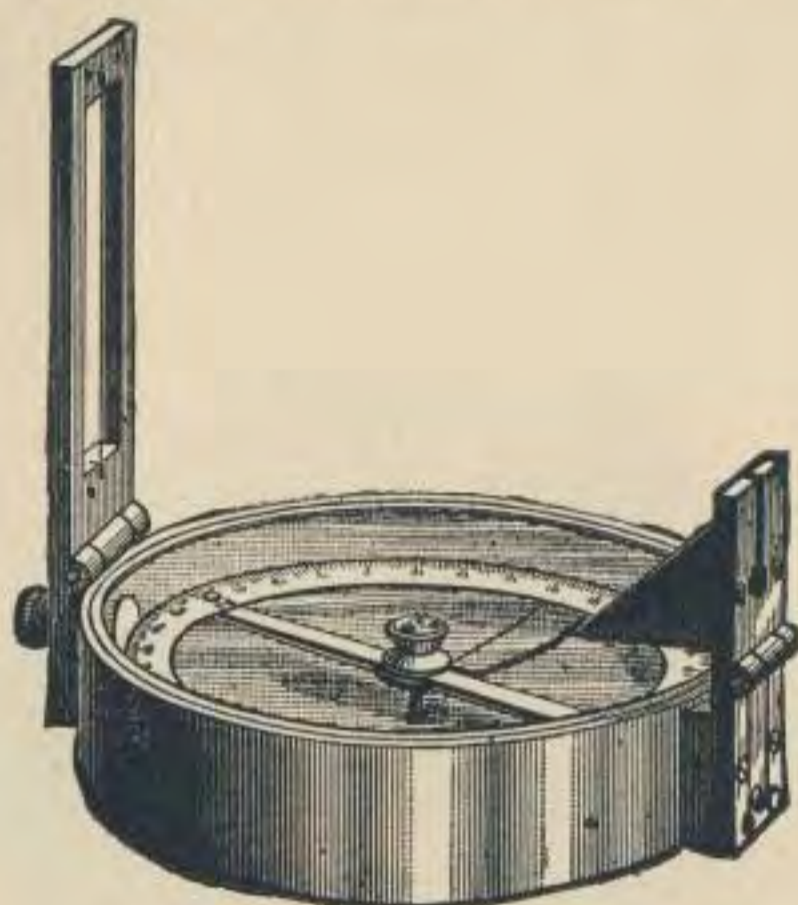
PRISMATIC COMPASSES.—*Continued.*

3228.

No.		PRICE.	POST
3228.	Prismatic Compass, 3 inches diameter, with floating metal dial divided to $\frac{1}{2}$ degrees, agate center with stop, folding prism and folding sight, with metal cover (not shown in cut), in leather sling case....	\$20.00	\$0.20
3230.	Prismatic Compass, Barker's Patent, $2\frac{3}{4}$ -inch floating dial, agate center with stop, mounted beneath $2\frac{3}{4}$ -inch pendulum dial, graduated for altitudes 0° to 180° , also graduated 0° to 90° both ways as clinometer and with scale of rise or fall in inches per yard; folding prism and hair sight, metal case and cover, in leather sling case.....	27.00	.25
3232.	Prismatic Compass, 3 inches diameter, with metal dial graduated to $\frac{1}{2}$ degrees, agate center with stop, folding prism, azimuth glasses, folding sight with hinged and sliding mirror, in leather sling case.....	30.00	

SEXTANTS.

No.		PRICE.
3240.	Pocket Sextant graduated to $\frac{1}{2}$ degrees, with vernier to 1 minute, telescope, two neutral glasses, magnifier, tangent screw, etc. In metal box 3 inches diameter, and in morocco case.....	\$42.50
3245.	Sextant of gun-metal, $4\frac{1}{2}$ inches radius, arc of 150° graduated on silver to 15 minutes with vernier to 15 seconds, clamp and tangent and magnifier, one terrestrial telescope, one celestial telescope, one sight-tube, six neutral glasses, two mirrors, in mahogany box.....	50.00
3247.	Sextant of gun-metal, $6\frac{1}{2}$ inches radius, arc of 150° graduated on silver to 10 minutes with vernier to 10 seconds, clamp and tangent and magnifier, two celestial telescopes, one terrestrial telescope, one sight-tube, seven neutral glasses, two mirrors, in mahogany box.....	80.00

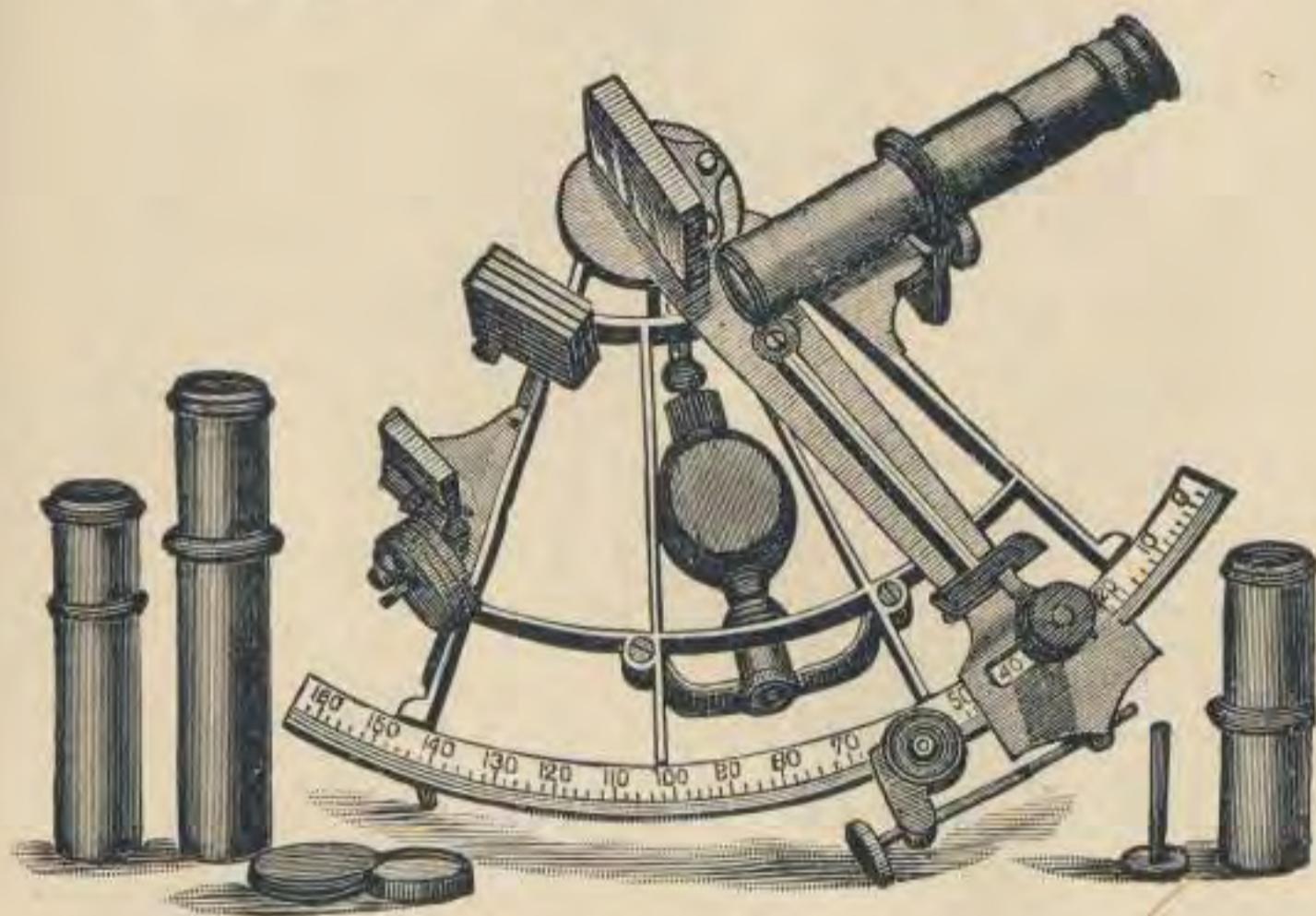

3248.

3248.	Sextant of gun-metal, superior, 7 inches radius, arc of 150° graduated on silver to 10 minutes with vernier to 10 seconds, clamp and tangent and magnifier, two celestial telescopes, one terrestrial telescope, one sight-tube, seven neutral glasses, two mirrors, in mahogany box.....	100.00
-------	--	--------

ARTIFICIAL HORIZONS, ANGLE-MIRRORS AND PRISMS. SURVEYORS' CROSS-STAFF HEADS.

No.		PRICE.	POST.
3250.	Artificial Horizon, with black glass plane mounted in brass frame, with three leveling-screws, and sensitive level-vial. All in mahogany box.....	\$16.00	\$0.30
3252.	Mercurial Horizon, iron trough, iron bottle with screw stopper and funnel cap, glazed metal roof. All in mahogany box.....	37.50	



3256.



3260.



3265.

3255.	Angle-Mirror, with small plummet, for angles of 90 degrees. The handle can be detached and stored in frame of instrument. Size, $2\frac{1}{4} \times 2 \times 1\frac{3}{4}$ inches, in morocco case.....	7.50	.12
3256.	Angle-Mirror, plain, for angles of 90°, in morocco case.....	5.00	.12
3260.	Rectangular Prism, for angles of 90°, $2\frac{1}{2} \times 1\frac{1}{4} \times 1\frac{5}{8}$ inches, in morocco case.....	5.00	.12
3262.	Double Prism, to take angles of 90° and 45°, in morocco case.....	10.00	.12
3265.	Surveyor's Cross-Staff Head, for 45° and 90° angles. Octagonal, $2\frac{1}{2}$ inches long. With staff socket.....	2.75	.30
3266.	Surveyor's Cross-Staff Head, for 45° and 90° angles. Octagonal, 3 inches long. With magnetic compass, $1\frac{3}{4}$ -inch needle, and with staff socket.....	4.75	.35
3267.	Surveyor's Cross-Staff Head, for 45° and 90° angles. Round, $3\frac{3}{4}$ inches long. With vertical axis graduated to 1° and vernier to 3 minutes. With magnetic compass, $2\frac{1}{8}$ -inch needle, and with staff socket.....	11.50	.40

PEDOMETERS, PASSOMETERS AND TALLY-REGISTER.



3270.

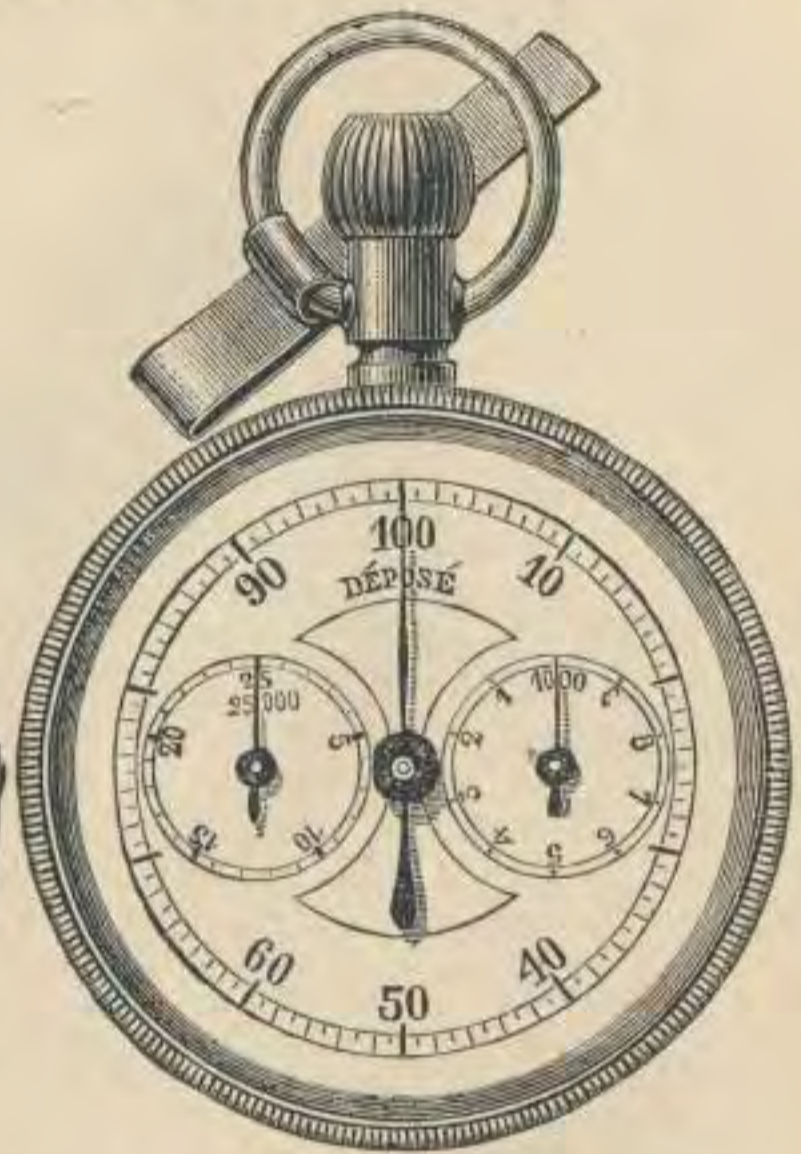

3276.

No.		PRICE.	POST.
3270.	Pedometer, watch form. One dial registers distance walked up to 12 miles by each $\frac{1}{4}$ mile.....	\$4.50	\$0.12
3272.	Pedometer, watch form. Two dials register distance walked up to 50 miles by each 80 yards.....	5.25	.12
3275.	Passometer, watch form. Three dials register each step up to 25,000 steps.....	6.00	.12
3276.	Passometer, same as No. 3275, but with stem attachment to set the pointers to zero at will.....	7.50	.12

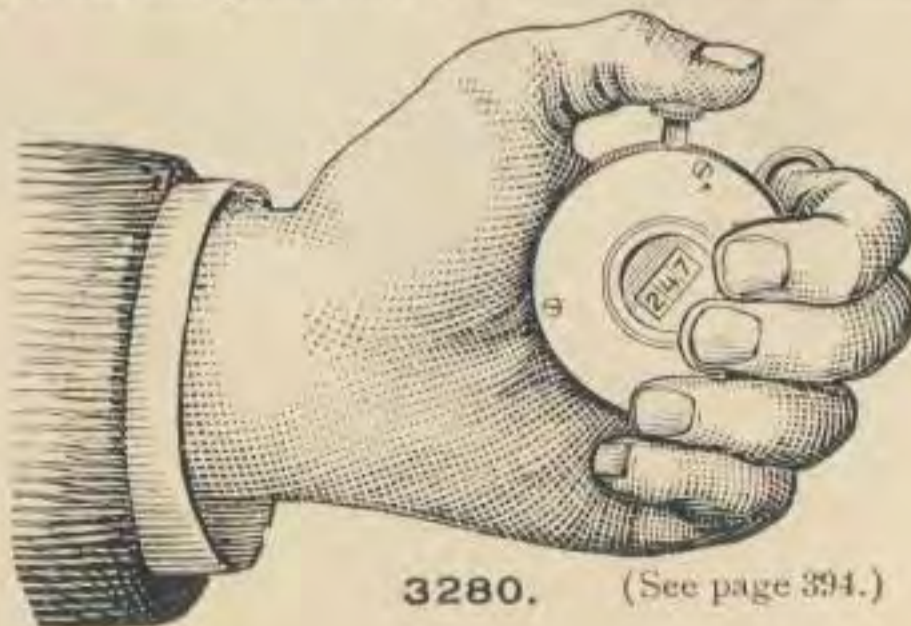

3280. (See page 394.)

No.		PRICE.	POST.
3280.	Tally-Register, for surveyors and others; useful in chaining, for counting persons, cattle, coal, wheat, etc. Registers to 1,000 and can be set to zero at will,	\$2.50	\$0.15

CLINOMETERS.

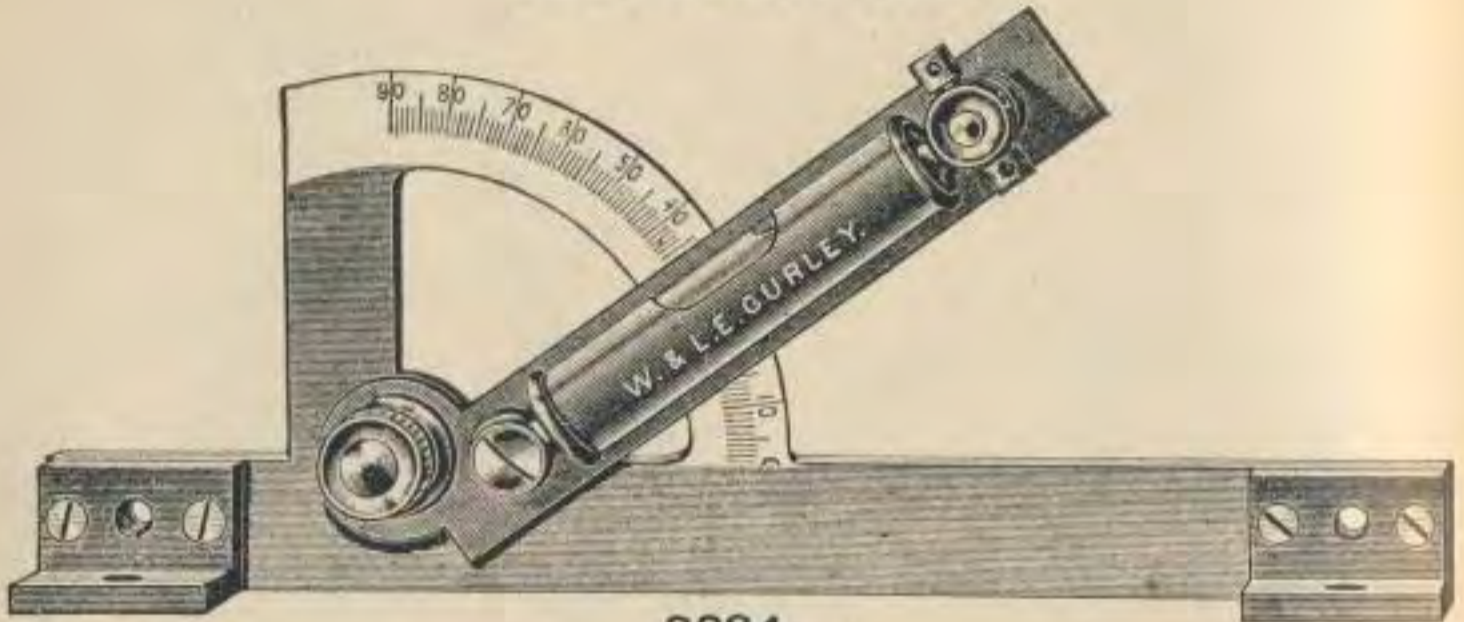

3284.

3284.	Clinometer or Slope-Level (Gurley, maker), 7 inches long, arc to whole degrees, in wood case...	8.00	.30
3286.	Clinometer or Slope-Level (Gurley, maker), 18 inches long, with vernier to 5 minutes, in wood case,	15.00	

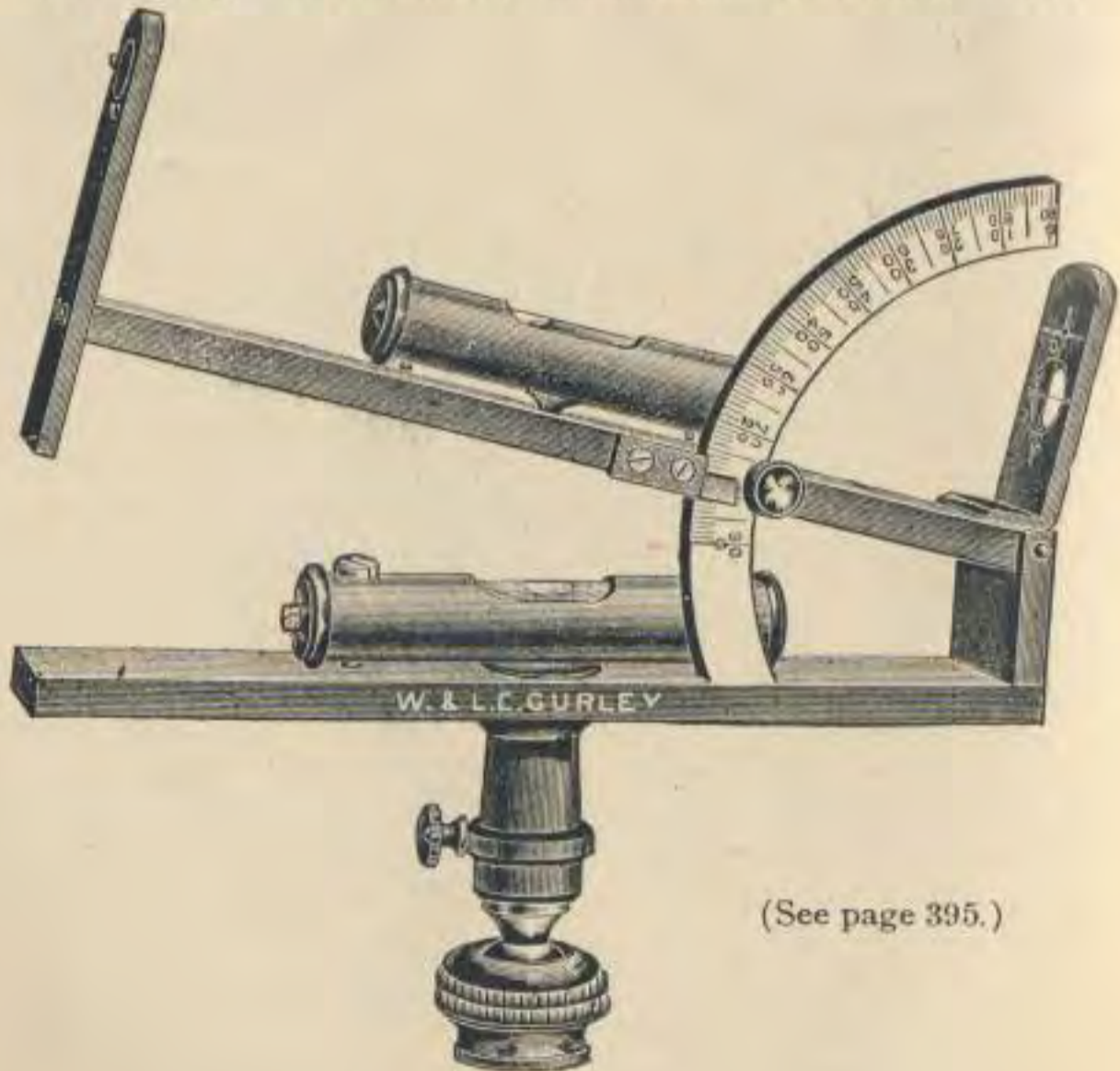

3288.

(See page 395.)

No.		PRICE.	POST.
3288.	Clinometer or Slope-Level (Gurley, maker), 6 inches long, arc to whole degrees, two levels, sights and staff mountings, in wood case.....	\$16.00	\$0.50

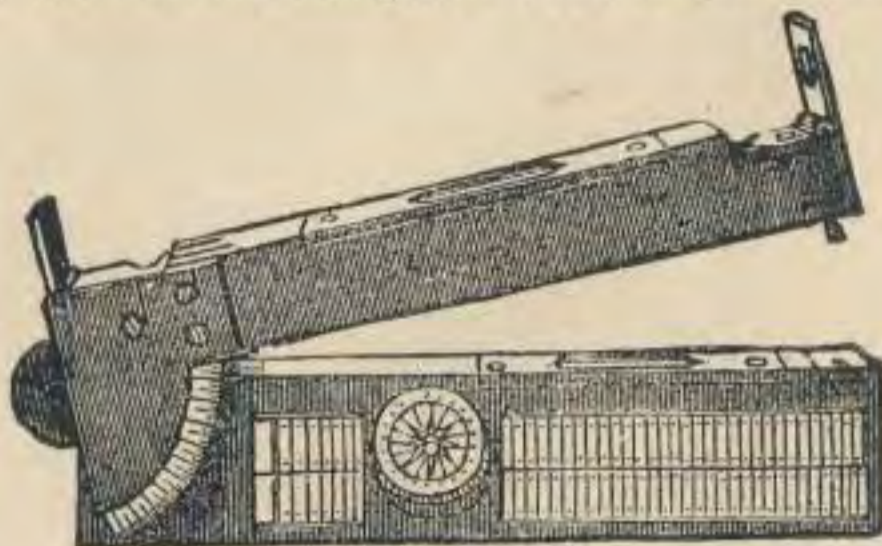

3290.

3290.	Boxwood Clinometer, 12-inch, folding to 6-in., with two levels, compass, inclination scale, and sights, in leather case.....	12.00	.20
-------	--	-------	-----

The inclination scale gives the value of any angle. The angle, ascertained from the graduated arc, refers to that degree in the column marked "angle," and another column gives the rise or fall in any given distance.

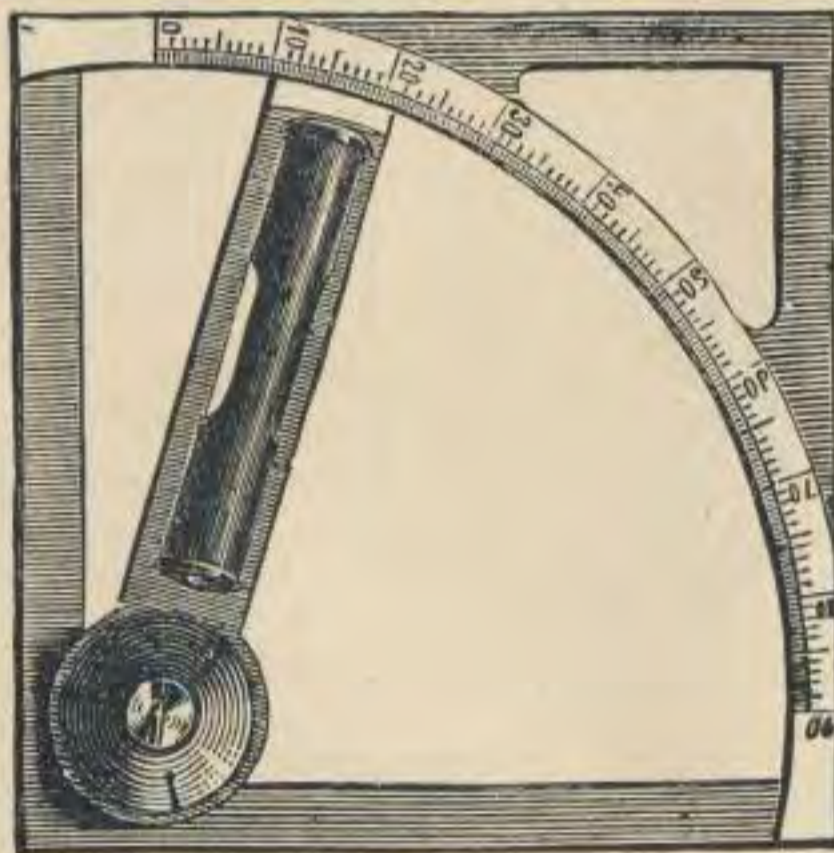

3292.

3292.	Clinometer or Slope-Level, brass frame, 4-in. square, arc to whole degrees and vernier to 5 minutes. The design renders the measurement of the inclination of the under side of a plane available, as any of the four edges may be used ; in wood case.	10.00	.40
-------	---	-------	-----

ANEROID BAROMETERS.

FOR ASCERTAINING HEIGHTS, DIFFERENCES OF LEVEL AND METEOROLOGICAL CHANGES, APPROACH OF STORMS, ETC.

Mountain Aneroid Barometers, compensated for temperature, with brass cases and silvered dials, in morocco cases.

No.		PRICE.	POST.
3300.	Pocket Aneroid, 2 inches diameter, altitude scale to 3,000 feet, by each 10 feet.....	\$18.00	\$0.20
3301.	Pocket Aneroid, 2 inches diameter, altitude scale to 5,000 feet, by each 20 feet.....	17.00	.20
3302.	Pocket Aneroid, 2 inches diameter, altitude scale to 10,000 feet, by each 50 feet.....	18.00	.20



3303.

3306.	Pocket Aneroid, $2\frac{3}{4}$ inches diameter, altitude scale to 10,000 feet, by each 50 feet, with thermometer, and opposite side with pocket-compass.....	27.00	.30
3308.	Pocket Aneroid, $2\frac{3}{4}$ inches diameter, altitude scale to 16,000 feet, by each 50 feet, with thermometer, and opposite side with pocket-compass.....	29.00	.30

No.		PRICE.	POST.
3310.	Pocket Aneroid, $2\frac{3}{4}$ inches diameter, altitude scale to 3,000 feet, by each 10 feet.....	\$19.00	\$0.25
3312.	Pocket Aneroid, $2\frac{3}{4}$ inches diameter, altitude scale to 5,000 feet, by each 20 feet.....	18.00	.25
3314.	Pocket Aneroid, $2\frac{3}{4}$ inches diameter, altitude scale to 10,000 feet, by each 50 feet.....	19.00	.25
3316.	Pocket Aneroid, $2\frac{3}{4}$ inches diameter, altitude scale to 16,000 feet, by each 50 feet.....	20.00	.25
3318.	Pocket Aneroid, $2\frac{3}{4}$ inches diameter, altitude scale to 20,000 feet, by each 100 feet.....	22.00	.25
3322.	Pocket Aneroid, $2\frac{3}{4}$ inches diameter, altitude scale to 10,000 feet, by each 50 feet, and thermometer..	22.00	.25
3324.	Pocket Aneroid, $2\frac{3}{4}$ inches diameter, altitude scale to 16,000 feet, by each 50 feet, and thermometer..	23.00	.25
3329.	Pocket Metric Aneroid, $2\frac{3}{4}$ inches diameter, altitude scale to 1,500 meters, reading to 5 meters, and pressure scale reading to $\frac{1}{2}$ millimeter	18.00	.25
3330.	Pocket Metric Aneroid, $2\frac{3}{4}$ inches diameter, altitude scale to 3,000 meters, reading to 10 meters, and pressure scale reading to 1 millimeter	19.00	.25
3332.	Pocket Metric Aneroid, $2\frac{3}{4}$ inches diameter, altitude scale to 5,000 meters, reading to 20 meters, and pressure scale reading to 2 millimeters	20.00	.25
3336.	Plain Aneroid, no altitude scale, 5 inches diameter, with thermometer and open face to show mechanism, for parlor use	15.00	
3338.	Plain Aneroid, no altitude scale, $6\frac{1}{2}$ inches diameter, and with two thermometers reading to scales of Fahrenheit, Reaumur and Celsius, and open face to show mechanism, for parlor use.....	18.00	
3340.	Self-Recording Aneroid Barometer, with attached thermometer. In mahogany case with glass front,	50.00	

This barometer is used by the U. S. Weather Bureau, and is simple in construction and accurate in its work. The cylinder makes a complete revolution in seven days, and thus each diagram gives a barometric record for one week.

NOTE.—The graduated spaces on the altitude scales of Barometers Nos. 3300 to 3332 can be subdivided by the eye or by using a magnifier and thus obtain a closer reading than advertised.

SURVEYING AND MINING ANEROIDS.

BRONZED CASES, SILVERED DIALS WITH REVOLVING MAGNIFIER. COMPENSATED FOR TEMPERATURE. IN LEATHER SLING CASES.

No.		PRICE.	Post.
3350.	Surveying Aneroid, 3 inches diameter, altitude scale to 6,000 feet, by each 20 feet and by vernier to 2 feet.....	\$42.00	\$0.40
3352.	Surveying Aneroid, 3 inches diameter, with altitude scale to 10,000 feet by each 50 feet and by vernier to 5 feet.....	45.00	.40
3355.	Mining Aneroid, 3 inches diameter, arranged to register 2,000 feet below sea-level to 4,000 feet above by each 20 feet and by vernier to 2 feet.....	42.00	.40
3360.	Surveying Aneroid, 5 inches diameter, with altitude scale to 5,000 feet by each 10 feet and by vernier to 1 foot.....	50.00	
3362.	Surveying Aneroid, 5 inches diameter, with altitude scale to 10,000 feet by each 20 feet and by vernier to 2 feet.....	52.00	
3364.	Surveying Aneroid, 5 inches diameter, with altitude scale to 15,000 feet by each 20 feet and by vernier to 2 feet.....	54.00	
3366.	Surveying Aneroid, 5 inches diameter, with altitude scale to 20,000 feet by each 50 feet and by vernier to 5 feet.....	57.00	

The Surveying and Mining Aneroid has been constructed especially for the use of Surveyors and Engineers, for ascertaining slight variations in gradients, levels, etc., and from its extreme sensitiveness will be found of considerable utility in Mining and Surveying work generally.

The Vernier Scale is moved by rack and pinion, and a reading-glass which rotates on the outer circumference of the instrument facilitates the reading of minute quantities.

A Treatise on the Aneroid Barometer; its construction and use. Illustrated. 50 cents.

Aneroid Barometers in Aluminum cases cost extra, as follows:

Barometers Nos. 3300 to 3302, if in Aluminum cases, extra.....	\$2.50
Barometers Nos. 3306 to 3308, if in Aluminum cases, extra.....	9.00
Barometers Nos. 3310 to 3332, if in Aluminum cases, extra.....	4.00
Barometers Nos. 3350 to 3355, if in Aluminum cases, extra.....	11.00
Barometers Nos. 3360 to 3366, if in Aluminum cases, extra.....	23.00

TO USE THE ANEROID, WITH ALTITUDE SCALE.

Find the height in feet at first station and subtract this from the height in feet at second station. If the mean temperature is greater or less than 50° F., apply correction for temperature as hereafter given.

Example :

Aneroid at Station A, 1800 feet. Thermometer, 50°.
 Aneroid at Station B, 800 feet. Thermometer, 70°.

The approximate height is 1,000 feet. The sum of the temperatures is 120. A correction of + 20 is therefore applied. This is 20 feet.

The difference of elevation is therefore $1,000 + 20 = 1,020$ feet.

TO FIND THE RELATIVE HEIGHT OF TWO GIVEN PLACES.

Take a reading of the Aneroid at first station ; subtract from this the reading at second station. The product multiplied by 9 will give the difference of altitude in feet thus :

First Station, 30.20 ; Second Station, 29.99 ; $30.20 - 29.99 = .21$;
 $.21 \times 900$ (or 21×9) = 189 feet = difference of altitude.

This under ordinary pressures and with a temperature about 50° F. will give good results. If the temperature is over 70° F. multiply by 10. The table prepared by Mr. Symons is more strictly accurate :

MEAN TEMPERATURE.	30°	40°	50°	60°	70°	80°
Mean pressures, 27 inches...	9.7	9.9	10.1	10.3	10.5	10.8
Mean pressures, 28 inches...	9.3	9.5	9.8	10.0	10.2	10.4
Mean pressures, 29 inches...	9.0	9.2	9.4	9.6	9.8	10.0
Mean pressures, 30 inches...	8.7	8.9	9.1	9.3	9.5	9.7

Roughly speaking, the barometer falls one inch for every 900 feet of ascent ; or at mean atmospheric pressure in this latitude,

Above sea-level 917 feet, the barometer falls..... 1 inch.
 Above sea-level 1860 feet, the barometer falls..... 2 inches.
 Above sea-level 2830 feet, the barometer falls..... 3 inches.
 Above sea-level 3830 feet, the barometer falls..... 4 inches.
 Above sea-level 4861 feet, the barometer falls..... 5 inches.

ANEMOMETERS.

FOR MEASURING THE PRESSURE AND VELOCITY OF CURRENTS OF AIR IN COAL MINES, AND VENTILATORS, FLUES, ETC., OF PUBLIC BUILDINGS.

“Biram’s.”—For registering the velocity of currents of air in mines, tunnels, etc., by means of a light fan, the revolutions of which are recorded on a dial in the center of the instrument.

This instrument placed in the passage of a mine registers automatically the rate at which the air is traveling through it, and a simple observation will detect any slackening of the current arising from obstruction of the ways, or want of attention at the ventilating furnace, or fan-wheel.

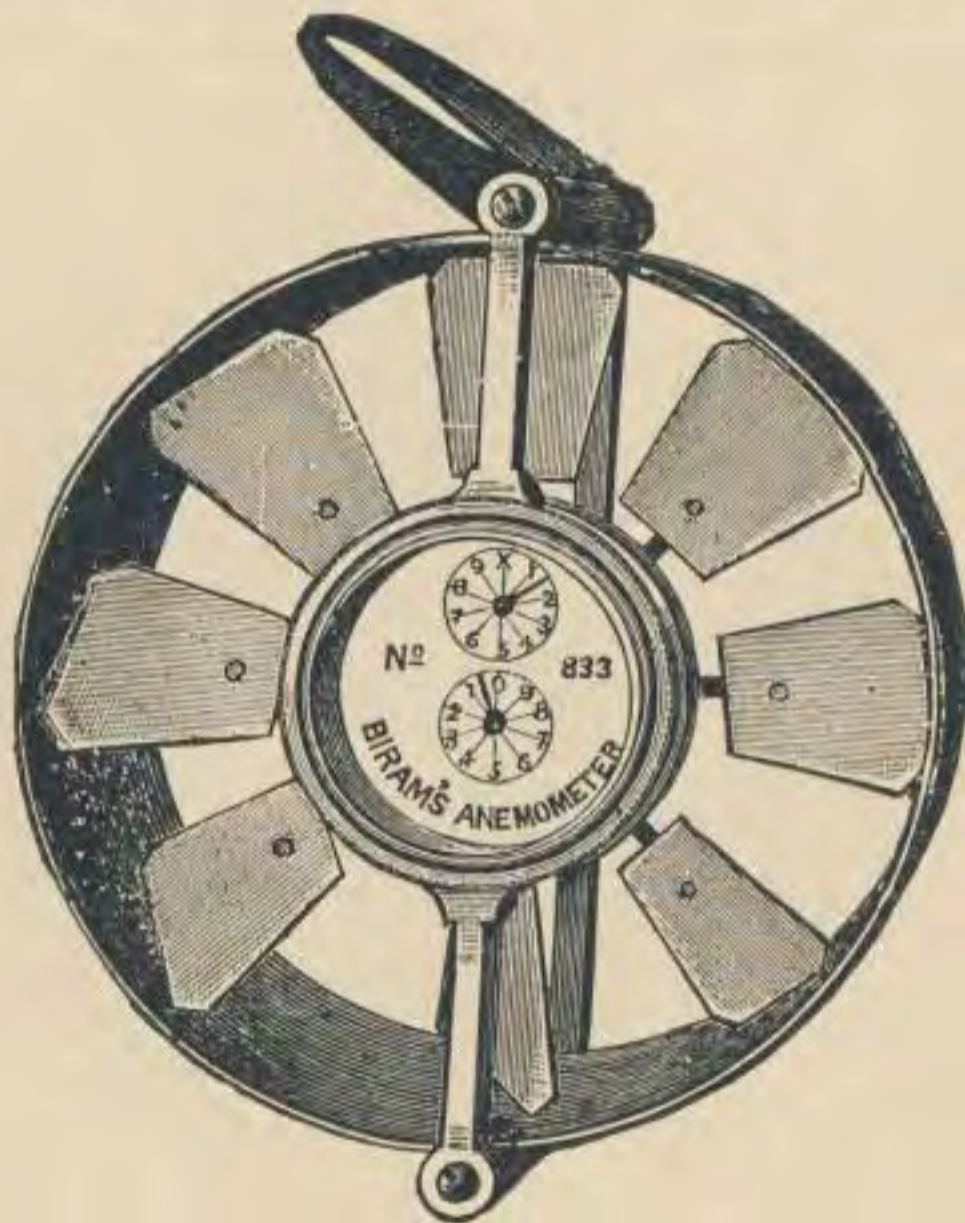

3380.

No.		PRICE.	POST.
3380.	Biram's Anemometer, 3 inches diameter, reading to 1,000 feet, with disconnecter, in morocco case....	\$19.00	\$0.30
3382.	Biram's Anemometer, 4 inches diameter, reading to 1,000 feet, with disconnecter, in wood case.....	19.00	.40
3384.	Biram's Anemometer, 6 inches diameter, reading to 1,000 feet, with disconnecter, in wood case.....	20.00	.60
3386.	Biram's Anemometer, 6 inches diameter, reading to 100,000 feet, with disconnecter, in wood case.....	22.00	.60

No.		PRICE.	POST.
3388.	Biram's Anemometer, 6 inches diameter, reading to 10,000,000 feet, with disconnecter, in wood case..	\$30.00	\$0.60
	Pocket Size, (<i>2 inches diameter</i>)—Is made in the form of a watch—the top and bottom of the case, when opened, form a base for the instrument, a check-spring passing through the pendant acts as a stop to the movement, on being pressed by the finger at the expiration of the time necessary to make the observation. The movement is jeweled at four points. The outer circle of divisions on the dial records by single feet up to one hundred; the smaller dial continues the enumeration up to one thousand feet.		
3390.	Biram's Anemometer, watch pattern, hunting-case, very sensitive, reading to 1,000 feet.....	26.00	.18

HOW TO USE THE ANEMOMETER.

The Anemometer consists of a series of vanes, which revolve with the action of the air-current, the number of revolutions, or numbers proportioned to the revolutions, being registered by a pointer on the face of a dial, forming part of the instrument itself. An observer has only to record the position of the several indices at the first observation (by writing the lower of the two figures on the respective circles, between which the index points, in their proper order), and deduct the amount from their position at the second observation, to ascertain the velocity of the air which has passed in the interval. This multiplied by the area in feet of the passage, where the instrument is placed will show the number of cubic feet which has passed during the same period.

Thus, suppose the observation of one minute gives :

Second reading.....	525
First reading.....	225
	300
Add correction, say	30
	330

Size of passage in feet, $10 \times 5 \times 330 = 16,500$ feet per minute.

The correction added above is the value of the constant of friction, which must be found for each machine by actual experiment.

TO FIND THE VELOCITY OF THE AIR IN THE PASSAGE.

Proceed thus: Suppose the Anemometer indicates 330 feet per minute. $330 \div 88 = 3.75$ or $3\frac{3}{4}$ miles per hour, 88 being $\frac{1}{80}$ th of a mile.

To ascertain the force of the air-current, multiply the square of the velocity of the air in feet per second by .0023.

AIR-METERS.

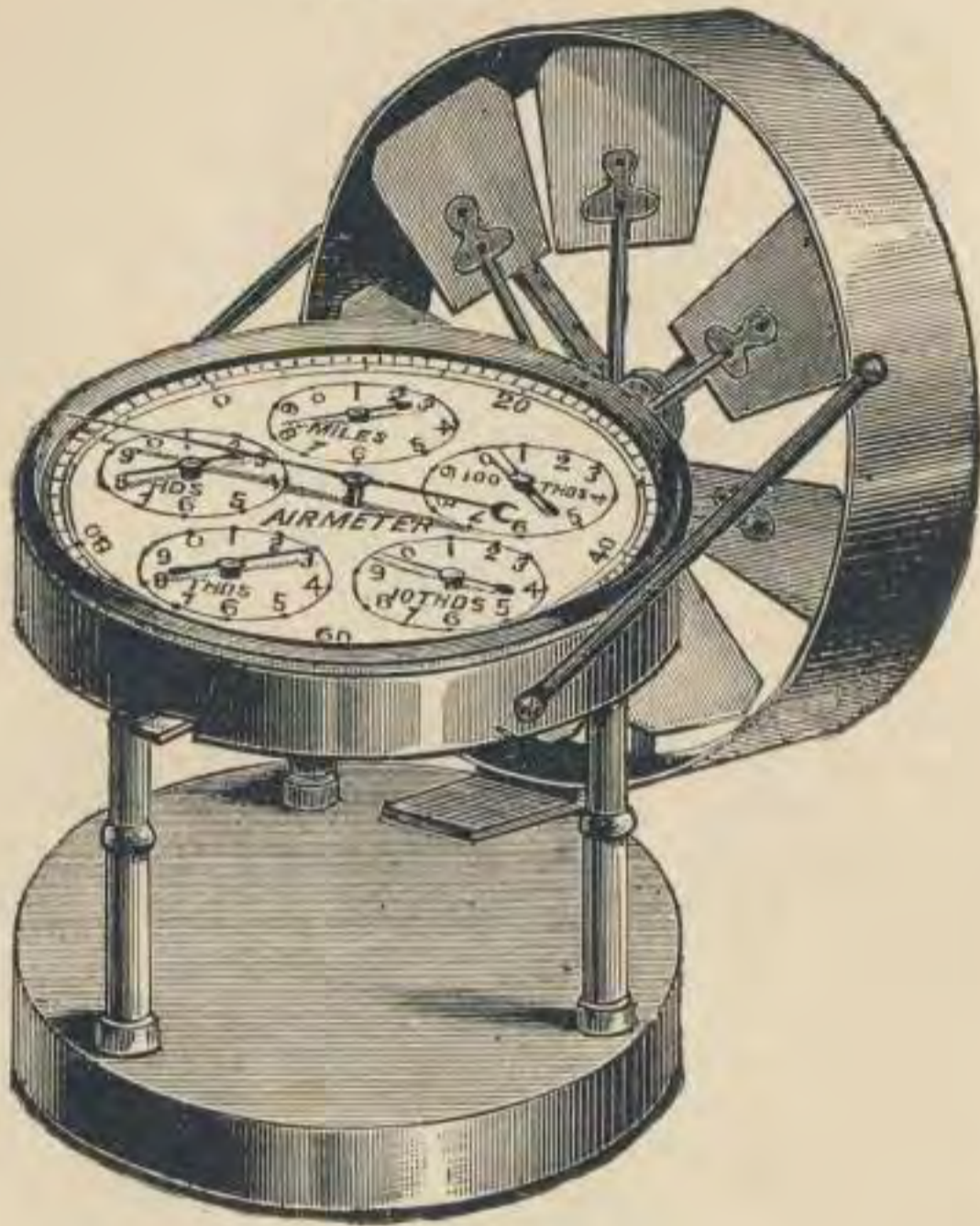

3397.

No.		PRICE.	Post
3396.	Air-Meter, with disconnector, fan-wheel $2\frac{3}{4}$ in. diameter, two dials reading to 1,000 feet.....	\$19.00	\$0.35
3397.	Air-Meter, with disconnector, fan-wheel $2\frac{3}{4}$ in. diameter, six dials reading to 10,000,000 feet.....	21.00	.35

The portable "*Air-Meter*" is for the measurement of currents of air through mines, tunnels, sewers and the ventilators of hospitals, public buildings, etc. The indications are obtained by means of a delicately poised fan-wheel, the recordings being commenced by the long hand, which traverses the extreme outer circumference of the main dial for the passage of one hundred feet of air. The enumeration is continued up to ten millions of feet (say 1,894 miles), by a series of smaller dials as shown in the illustration. A "Disconnector" projecting from the band of the instrument, opposite the fan-wheel, serves to throw the mechanism out of gear, and arrest its action, when required. The instrument is packed, with universal jointed socket-holder, in a box about four inches square.

MARINE AND FIELD-GLASSES.

The power and sharpness of definition of a Field-Glass depend upon the diameter of the object-glass.

These Glasses are designated and priced according to the diameter of the object-glasses in French lines, eleven lines being equal to one inch.



3400.

Six Lens Achromatic Field-Glass, metal body, covered with morocco, sun-shades to extend over the object-glasses, and morocco case with strap.

No.		PRICE.	POST.
3400.	Body, $4\frac{3}{4}$ inches long ; object-glasses, 21 lines.....	\$7.00	\$0.30
3402.	Body, $6\frac{1}{4}$ inches long ; object-glasses, 26 lines.....	9.00	.40

Six Lens Achromatic Marine or Field-Glass, metal body, covered with leather, sun-shades to extend over the object-glasses, and leather case with strap.

3407.	Body, $5\frac{7}{8}$ inches long ; object-glasses, 24 lines.....	14.00	.45
3408.	Body, $6\frac{1}{4}$ inches long ; object-glasses, 26 lines.....	15.00	.50

Bardou's U. S. Army Signal Service Marine or Field-Glass, six lenses, achromatic object-glasses, metal body, covered with Turkey morocco, sun-shades to extend over the object-glasses, and leather case with strap ; very superior.

3413.	Body, $6\frac{3}{8}$ inches long ; object-glasses, 24 lines.....	18.00	.45
3414.	Body, $6\frac{3}{8}$ inches long ; object-glasses, 26 lines.....	20.00	.50

Bardou's U. S. Army Signal Service Marine or Field-Glass, six lenses, achromatic object-glasses, metal body, covered with Turkey morocco, sun-shades to extend over the object-glasses, hinge adjustment for different widths of eyes, and leather case with strap; very superior.

No.		PRICE.	POST.
3416.	Body, $6\frac{3}{8}$ inches long; object-glasses, 24 lines.....	\$20.00	\$0.45
3417.	Body, $6\frac{3}{8}$ inches long; object-glasses, 26 lines.....	23.00	.50

BINOCULAR TELESCOPE.—This field-glass has great power and wonderful optical qualities, and can be adjusted to the distance between the eyes.

It has sun-shades and leather case with strap.

3420.	Length, $5\frac{1}{4}$ inches; diameter of object-glasses, 8 lines; power, 10 diameters.....	27.00	.35
3423.	Length, $9\frac{1}{2}$ inches; diameter of object-glasses, 16 lines; power, 16 diameters.....	45.00	.75
3424.	Length, 11 inches; diameter of object-glasses, 19 lines; power, 20 diameters.....	50.00	.90

RANCHMAN'S GLASS.—Six Lens Achromatic Field-Glass, metal body covered with morocco, sun-shades to extend over the object-glasses, and leather case with strap. A superior glass.

3430.	Body, $6\frac{3}{8}$ inches long; object-glasses, 26 lines.....	18.00	.50
-------	---	-------	-----

PANERGETIC GLASS.—Six Lens Achromatic Field-Glass, aluminum body (light weight), covered with morocco, sun-shades and leather case with strap. This is a new style and a superior glass.

3434.	Body, 4 inches long; object-glasses, 21 lines.....	23.00	.30
3435.	Body, $4\frac{1}{2}$ inches long; object-glasses, 24 lines.....	26.00	.35
3436.	Body, $4\frac{7}{8}$ inches long; object-glasses, 26 lines.....	29.00	.40
3437.	Body, 4 inches long; object-glasses, 21 lines, and with hinge adjustment.....	28.00	.30

IMPROVED OPERA AND FIELD-GLASS.

This glass has a double draw to the eye end, like a telescope.

3440.	Body, $3\frac{1}{2}$ inches long; object-glasses, 17 lines.....	\$15.00	\$0.30
3441.	Body, 4 inches long; object-glasses, 19 lines.....	16.00	.35

NOTE.—We also have constantly on hand a full and choice assortment of plain and fancy Opera Glasses, of best make. Sizes, from 11 to 19 lines diameter. Prices, from \$5.00 to \$25.00 each.

ACHROMATIC TELESCOPES.

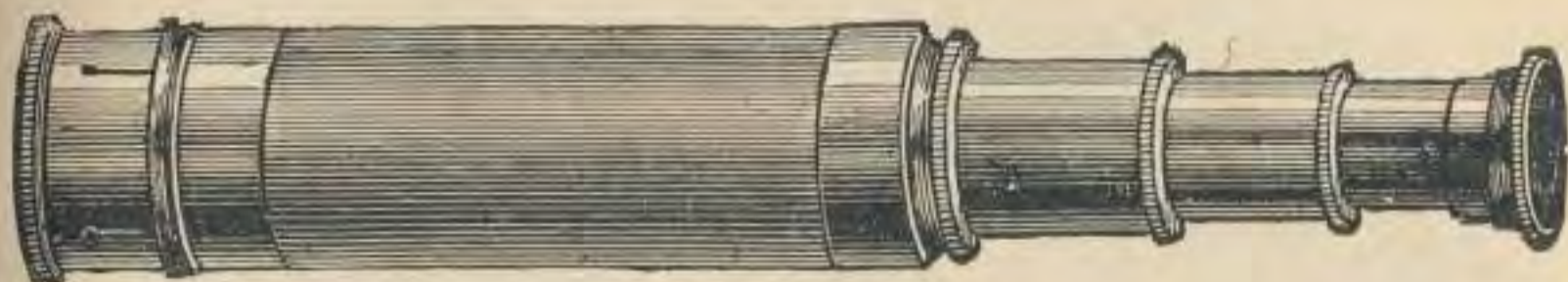

3475.

No.		PRICE.	POST.
3475.	Telescope, with 3 draws, 15 inches drawn out, 6 inches shut, object-glass 1 inch in diameter, power 13 times.....	\$2.50	\$0.20
3476.	Telescope, with 3 draws, 16 inches drawn out, 6 inches shut, object-glass $1\frac{1}{8}$ inches in diameter, power 16 times.....	3.50	.25
3477.	Telescope, with 3 draws, 23 inches drawn out, 8 inches shut, object-glass $1\frac{3}{8}$ inches in diameter, power 20 times.....	5.00	.30
3478.	Telescope, with 3 draws, 30 inches drawn out, 10 inches shut, object-glass $1\frac{5}{8}$ inches in diameter, power 25 times.....	7.00	.40
3479.	Telescope, with 4 draws, 37 inches drawn out, 11 inches shut, object-glass $1\frac{7}{8}$ inches in diameter, power 35 times.....	10.00	.65
3480.	Telescope, with 4 draws, 42 inches drawn out, $11\frac{1}{2}$ inches shut, object-glass $2\frac{1}{8}$ inches in diameter, power 40 times.....	17.00	.85
3481.	Telescope with 4 draws, 48 inches drawn out, $13\frac{1}{2}$ inches shut, object-glass $2\frac{3}{8}$ inches in diameter, power 50 times.....	30.00	

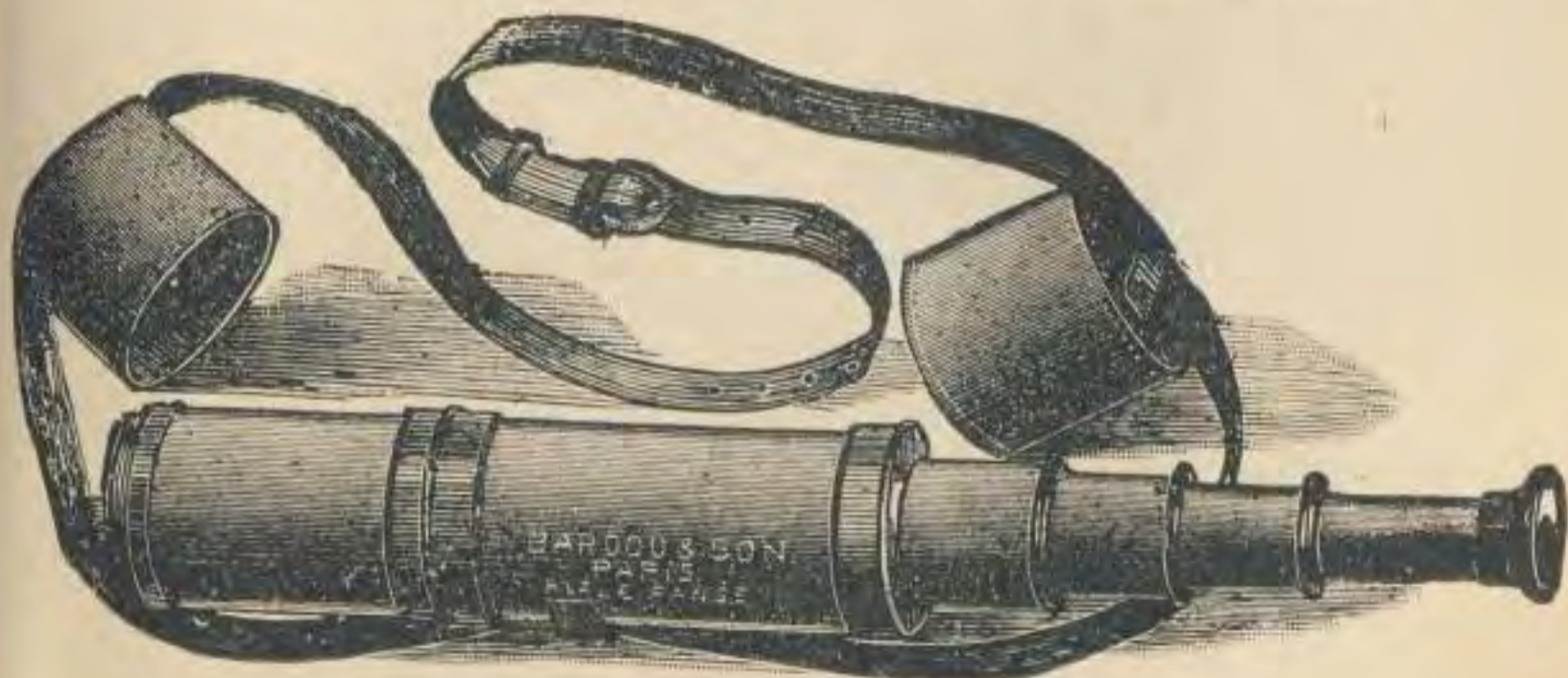

3485. (See page 406.)

TOURISTS' ACHROMATIC TELESCOPES.

No.		PRICE,	POST.
3485.	Telescope, with brass body covered with morocco; three draws, 17 inches drawn out, 6 inches shut; object-glass $1\frac{1}{4}$ inches in diameter; sun-shade; leather caps to cover eyepiece and object-glass and shoulder strap. Power 20 times.....	\$8.00	\$0.20
3486.	Telescope, same as No. 3485, but is 21 inches drawn out, 7 inches shut; object-glass $1\frac{5}{8}$ inches in diameter. Power 25 times.....	11.00	.30
3487.	Telescope, same as No. 3485, but is 24 inches drawn out, 9 inches shut; object-glass $1\frac{3}{4}$ inches diameter. Power 30 times.....	15.00	.40
3488.	Telescope, same as No. 3485, but has four draws, 36 inches drawn out, 10 inches shut; object-glass 2 inches in diameter. Power 35 times.....	22.00	.60
3492.	Rifle Spy-glass, $10\frac{3}{4}$ inches drawn out; body covered with morocco; object-glass $\frac{1}{2}$ -inch in diameter. Power 10 times.....	2.50	.15
3494.	Wooden Tripod Stand, with vertical and horizontal motion, upon which to place a telescope; a useful article, as a telescope of much power can not be held in the hand with sufficient steadiness.....	5.00	
3496.	Brass Clamp with Gimlet Screw, to fasten a telescope to a post or tree; four sizes to fit telescopes Nos. 3475 to 3488. Price according to size.....\$1.50, 2.00, 2.50 and	3.50	.15

ASTRONOMICAL TELESCOPES.

		PRICE.
3502.	Astronomical Telescope, polished brass body, 35 inches long, mounted on brass tripod stand, achromatic object-glass $2\frac{3}{4}$ inches in diameter, one terrestrial eyepiece, power 50 times, one celestial eyepiece, power 100 times, rack and pinion for focusing. In box with lock.....	\$75.00
3506.	Astronomical Telescope, polished brass body, 35 inches long, rack and pinion for focusing, achromatic object-glass, $2\frac{1}{2}$ inches in diameter, terrestrial eyepiece, power 40 times, celestial eyepiece with darkener, power 80 times, wooden tripod with horizontal and vertical motion. In box with lock, for receiving the body and eyepieces...	75.00
3508.	Astronomical Telescope. Same as No. 3506, but with body 40 inches long, achromatic object-glass 3 inches in diameter, terrestrial eyepiece, power 55 times, celestial eyepiece with darkener, power 110 times. In box with lock.....	100.00

POCKET MAGNIFIERS.



3520.



3526.

RUBBER CASE, OVAL FORM, 1 DOUBLE-CONVEX LENS.

No.		PRICE.	POST.	No.		PRICE.	POST.
3520.	1-inch.....	\$0.40	\$0.02	3522.	1½-inch.....	\$0.70	\$0.03
3521.	1¼-inch.....	.60	.02	3523.	2-inch.....	1.15	.12

RUBBER CASE, OVAL FORM, 2 DOUBLE-CONVEX LENSES.

3526.	7⁄8 and 1-inch....	\$0.65	\$0.03	3528.	1¼ and 1½-inch.	\$1.10	\$0.12
-------	--------------------	--------	--------	-------	-----------------	--------	--------

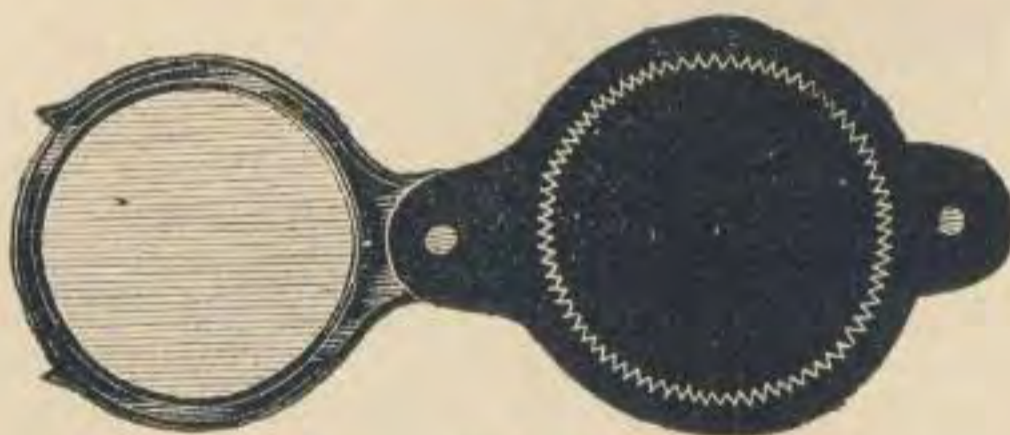

3530.

RUBBER CASE, BELLOWS FORM, 1 DOUBLE-CONVEX LENS.

3530.	¾-inch.....	\$0.40	\$0.02	3532.	1-inch.....	\$0.60	\$0.02
-------	-------------	--------	--------	-------	-------------	--------	--------

RUBBER CASE, BELLOWS FORM, 2 DOUBLE-CONVEX LENSES.

3534.	5⁄8 and ¾-inch..	\$0.60	\$0.02	3536.	7⁄8 and 1-inch..	\$1.00	\$0.12
-------	------------------	--------	--------	-------	------------------	--------	--------

RUBBER CASE. BELLOWS FORM, 3 DOUBLE-CONVEX LENSES.

No.	PRICE.	Post.	No.	PRICE.	Post.		
3538.	$\frac{1}{2}$, $\frac{5}{8}$ and $\frac{3}{4}$ -inch	\$0.80	\$0.03	3539.	$\frac{3}{4}$, $\frac{7}{8}$ and 1-inch	\$1.30	\$0.12
3542.	White Celluloid Case, oval form, one 1-inch double-convex lens.....			\$0.75	\$0.02		
3546.	Aluminum Case, oval form, one 1-inch double-convex lens.....			.75	.02		
3550.	German Silver Case, oval form, one 1-inch double-convex lens.....			.60	.04		
3555.	Microscope, brass mounted, on three legs adjustable.			.75	.05		



3560.

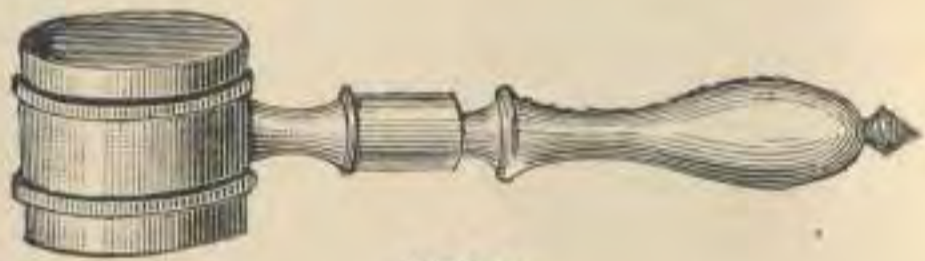

3566.

3560.	Linen Prover, for counting threads in linen fabrics, brass mounted, $\frac{1}{4}$ -inch square open space.....	.50	.02
3561.	Linen Prover, for counting threads in linen fabrics, brass mounted, $\frac{1.8}{100}$ -inch round open space.....	.50	.02
3562.	Linen Prover, for counting threads in linen fabrics, brass mounted, $\frac{1.8}{100}$ -inch round and $\frac{1}{4}$ -inch square open spaces.....	.60	.02
3565.	Linen Prover, for counting threads in linen fabrics, brass mounted, 1-inch square open space.....	1.75	.13
3566.	Coddington Lens, brass mounted, small.....	1.00	.12
3567.	Coddington Lens, brass mounted, medium.....	1.35	.14
3568.	Coddington Lens, brass mounted, large.....	1.75	.15
3569.	Aplanatic Magnifier, high power, and flat field.....	1.00	.12



3570.



No.		PRICE.	POST
3570.	Coddington Lens, nickeled frame and cover, $\frac{1}{2}$ -inch focus.....	\$1.50	\$0.12
3571.	Coddington Lens, nickeled frame and cover, $\frac{3}{4}$ -inch focus	1.75	.12
3572.	Coddington Lens, nickeled frame and cover, 1-inch focus	2.00	.12
3575.	Aplanatic Triplet, nickeled frame and cover, superior quality, giving perfect definition, $\frac{1}{2}$ -inch focus, power 20 times.....	6.00	.12
3577.	Aplanatic Triplet, nickeled frame and cover, superior quality, giving perfect definition, 1-inch focus, power 10 times.....	6.00	.12

Lenses Nos. 3566 to 3577 have extra power and definition for examining minerals, ore, rock, flowers, etc.

READING AND PICTURE-GLASSES.



READING-GLASS, METAL FRAME, DOUBLE-CONVEX LENS.

No.	PRICE.	POST.	No.	PRICE.	POST.
3585.	2 inches diam..\$0.80	\$0.05	3589.	4 inches diam..\$2.50	\$0.18
3586.	2 $\frac{1}{2}$ inches diam 1.00	.13	3591.	5 inches diam.. 4.00	.35
3587.	3 inches diam.. 1.50	.15	3593.	6 inches diam.. 6.00	.40

READING-GLASS, METAL FRAME, TWO PLANO-CONVEX LENSES.

3595.	2 inches diam.. 1.25	.15	3597.	3 inches diam.. 2.25	.20
3596.	2 $\frac{1}{2}$ inches diam 1.50	.18	3598.	3 $\frac{1}{2}$ inches diam 3.25	.25

READING-GLASS, OBLONG METAL FRAME, DOUBLE-CONVEX LENS.

3600.	2 $\frac{3}{4}$ x 1 $\frac{1}{2}$ inches.. 1.50	.13	3602.	3 $\frac{1}{4}$ x 1 $\frac{1}{2}$ inches.. 2.00	.18
3601.	3 x 1 $\frac{1}{2}$ inches.. 1.75	.15	3603.	3 $\frac{1}{2}$ x 1 $\frac{3}{4}$ inches.. 2.50	.20

POCKET SPIRIT-LEVELS, (French Make.) -

PLAIN VIALS, MOUNTED IN BRASS.

No.		PRICE.	POST.	No.		PRICE.	POST.
3650.	3 inches.....	\$0.50	\$0.06	3652.	9 inches.....	\$1.50	\$0.23
3651.	6 inches.....	1.00	.18	3653.	12 inches.....	2.00	.28

POCKET SPIRIT-LEVELS.

A superior article. Our own make, with ground and graduated vial, mounted in brass and adjustable.



3660.

3660.	6 inches.....	\$3.00	\$0.18	3664.	10 inches.....	\$4.00	\$0.25
-------	---------------	--------	--------	-------	----------------	--------	--------

LEVEL-VIALS, UNMOUNTED.

OUR OWN MAKE, AND EVERYONE TESTED.



3675.

3675.	Ground and Graduated Level-Vials, unmounted :					
	1½ inches.....	\$0.45	2 inches.....	\$0.50	2½ inches.....	\$0.60
	3 inches.....	.75	3½ inches.....	.90	4 inches.....	1.05
	4½ inches.....	1.20	5 inches.....	1.45	5½ inches.....	1.65
	6 inches.....	1.80	6½ inches.....	2.00	7 inches.....	2.25
3690.	Ground Level-Vials, not graduated, unmounted :					
	1 to 1½ inches..	.35	2 inches.....	.40	2½ inches.....	.50
	3 inches.....	.60	3½ inches.....	.75	4 inches.....	.90
	4½ inches.....	1.00	5 inches.....	1.25	5½ inches.....	1.40
	6 inches.....	1.50	6½ inches.....	1.65	7 inches.....	1.85
3710.	Plain Level-Vials, not graduated, unmounted :					
	1 to 1½ inches..	.10	2 inches.....	.12	2½ inches.....	.13
	3 inches.....	.15	3½ inches.....	.18	4 inches.....	.20
	4½ inches.....	.25	5 inches.....	.35	5½ inches.....	.40
	6 inches.....	.50	6½ inches.....	.60	7 inches.....	.75

NOTE.—If sent by mail, the postage on unmounted level-vials 1½ to 7 inches, will be 3 cents to 18 cents, according to size.

CARPENTERS' AND MASONS' SPIRIT-LEVELS.

No.		PRICE.
3726.	Cherry Body, 26 inches long, with level and plumb vials,	\$0.75
3727.	Cherry Body, 28 inches long, with level and plumb vials,	.85
3730.	Cherry Body, 26 inches long, brass ends, both vials adjustable.....	1.25
3731.	Cherry Body, 28 inches long, brass ends, both vials adjustable.....	1.35
3734.	“ Handy ” Plumb and Level, cherry body, 26 inches long, brass ends, adjustable vials.....	1.50
3738.	Mahogany Body, 28 inches long, brass ends, adjustable vials,	1.75
3740.	Iron Frame, 22 inches long, adjustable vials. Superior.....	3.50

OILSTONES.

		PRICE.	POST.
3765.	Arkansas Oilstones, fine quality, for drawing-pens..	\$0.25	\$0.00
3766.	Arkansas Oilstones, fine quality, 3 inches, in wood block with cover.....	.75	.10
3768.	Arkansas Oilstones, fine quality, 5 inches, in wood block with cover.....	1.75	.25
3775.	Washita Oilstones, common, 5 inches, in wood block with cover.....	.75	.20

IMPROVED TRAMMEL POINTS.

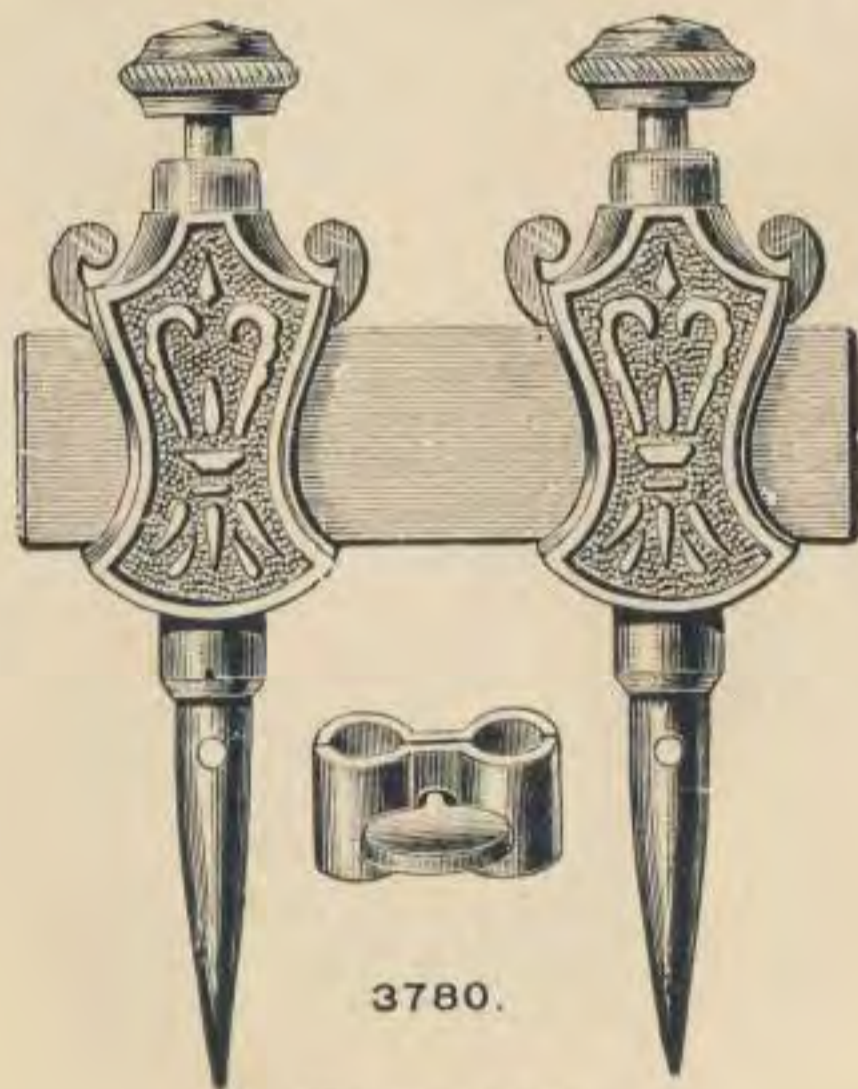

3780.

(See page 412.)

No.		PRICE.	POST.
3780.	Trammel Points, small, No. 1, see page 411.....	\$1.00	\$0.15
3781.	Trammel Points, medium, No. 2.....	1.25	.20
3782.	Trammel Points, large, No. 3.....	1.65	.25
3800.	Machinists' Tools, Lathe and Drill-Chucks and Drills, Steel Squares and Gauges, Brass Tubing and Wire, Sheet Brass and German Silver, Stubs' Steel Wire, etc., etc., at manufacturers' prices.		

STEEL MAGNETS.

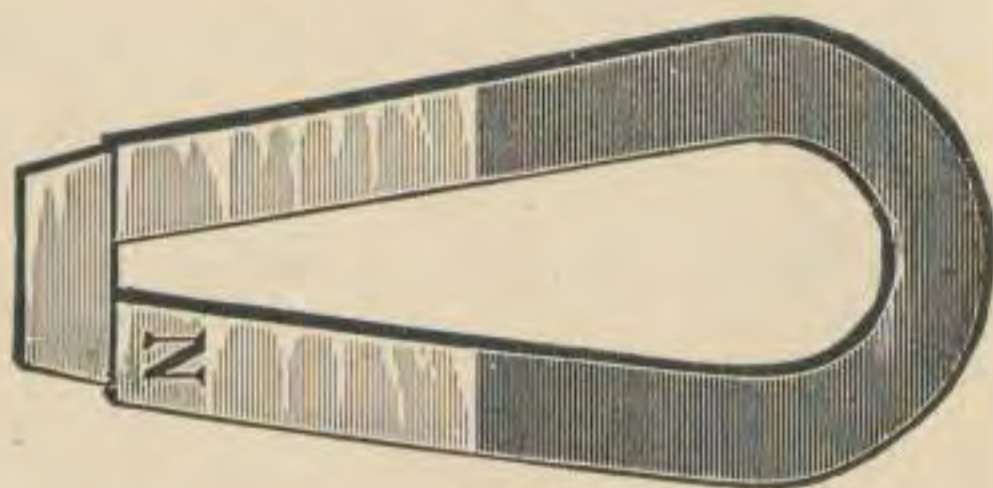

3850.

No.		PRICE.	POST.	No.		PRICE.	POST.
3850.	2 inches.....	\$0.12	\$0.03	3856.	5 inches.....	\$0.50	\$0.10
3852.	3 inches.....	.20	.04	3858.	6 inches.....	.75	.18
3854.	4 inches.....	.35	.06	3860.	7 inches.....	1.10	.20

BRASS BLOW-PIPES.

PLAIN.				WITH BULB.			
3865.	8 inches.....	\$0.15	\$0.05	3875.	8 inches.....	\$0.30	\$0.05
3867.	10 inches.....	.20	.06	3877.	10 inches.....	.35	.06
3869.	12 inches.....	.25	.07	3879.	12 inches.....	.40	.07

THERMOMETERS IN JAPANNED CASES.

(OPEN AIR SCALE.)

COMMON.				FINE QUALITY.			
3890.	6 inches.....	\$0.30	\$0.06	3900.	7 inches.....	\$0.50	\$0.08
3892.	8 inches.....	.40	.10	3901.	8 inches.....	.65	.12
3894.	10 inches.....	.55	.12	3903.	10 inches.....	.85	.15
3896.	12 inches.....	.65	.18	3905.	12 inches.....	1.00	.25
3910.	8 inches, fine quality with boiling scale75	.12
3912.	10 inches, fine quality with boiling scale.....					1.00	.25

THERMOMETERS WITH FANCY WOOD BACKS.

(OPEN AIR SCALE.)

OAK BACK.				MAHOGANY BACK.			
No.		PRICE.	POST.	No.		PRICE.	POST.
3920.	8 inches.....	\$1.00	\$0.18	3930.	8 inches.....	\$1.15	\$0.18
3922.	10 inches.....	1.25	.20	3932.	10 inches.....	1.35	.20
3924.	12 inches.....	1.50	.25				
3935.	Pocket Thermometer, folding wood case, 5½-inch...					1.00	.15
3938.	Pocket Thermometer, in metal tube, nickel-plated, 5-inch.....					.85	.12
3940.	Window Thermometer, 8-inch, plate-glass, white face, nickeled brackets.....					1.50	.25
3943.	Brewers' Copper Case Thermometer, 12-inch and deep cup.....					2.50	.30
3945.	Dairy Thermometer, all glass, floating, 8-inch.....					.35	.07
3950.	Chemical Thermometer, all glass, 60° to 300°, 14-inch.....					4.00	.25
3952.	Chemical Thermometer, all glass, 60° to 400°, 14-inch.....					4.50	.25
3954.	Chemical Thermometer, all glass, 60° to 500°, 14-inch.....					5.00	.25

SELF-REGISTERING THERMOMETERS.

No.		PRICE.	POST.
3960.	Maximum Thermometer, 10-inch, wood back.....	\$2.75	\$0.20
3962.	Maximum Thermometer, U. S. Weather Bureau pattern, 12-inch, aluminum back.....	5.00	.20
3965.	Minimum Thermometer, 10-inch, wood back.....	2.25	.20
3967.	Minimum Thermometer, U. S. Weather Bureau pattern, 12-inch, aluminum back.....	4.25	.20
3970.	U. S. Weather Bureau set of Maximum and Minimum Thermometers, 12-inch, aluminum back, and mounted together on one wood back.....	9.50	.50
3975.	Mason's Hygrometer, consisting of dry and wet bulb thermometers mounted on one wood back, 7-inch,	2.50	.30

All these Thermometers have the Fahrenheit scale.

RAIN-GAUGES.

No.		PRICE
3980.	Smithsonian Rain-Gauge, made of brass. This gauge is the most simple in its construction of any now in use. It is furnished with a measuring-stick which reads to 10ths and 100ths of inches; also a wooden cylinder to insert in the ground for the protection and ready adjustment of the instrument.....	\$5.00
3981.	U. S. Weather Bureau Standard Rain and Snow-Gauge, 8-inch diameter, 25½-inch high, with measuring-stick	6.00
3982.	Howard's Rain-Gauge, consisting of a vertical glass bottle, through the neck of which the terminal tube of a galvanized iron funnel, 5 inches in diameter, is inserted. A glass graduate, measuring to 100ths of an inch, is furnished with the instrument.....	4.00

HYDROMETERS.

(WITH BAUME'S SCALE.)

		PRICE.	POST
3990.	Hydrometers, for testing Acid, Alkalies, Ammonia, Bark, Beer, Ether, Milk, Molasses, Oils, Salt Water, Spirits, Syrup, Urine, Vinegar. Each....	\$0.75	\$0.10
3995.	Twaddel's Hydrometers, Nos. 1 to 6 with scales respectively 0 to 24, 24 to 48, 48 to 72, 72 to 100, 100 to 134, 134 to 180, each graduation representing five degrees of specific gravity. Each.....	.75	10

SCIENTIFIC BOOKS

FOR SALE BY

W. & L. E. GURLEY,

TROY, N. Y., U. S. A.

Architecture, Carpentry and Building, Astronomy, Bridges and Roofs, Chemistry and Physics, Construction, Strength of Materials, Drawing, Electricity and Telegraphy, Geology, Mining and Metallurgy, Hydraulic and Sanitary Engineering, Machinery and Mechanics, Pocket Table-Books, Surveying and Engineering-Instruments, Etc.

NOTE.—Parties ordering should either send drafts on New York, or postal orders on Troy, N. Y.; or if money is enclosed in letters, such letters should be registered at the post-office where mailed.

We prepay postage on nearly all American and English Books when the price is sent to us in advance.

Books can be registered at an extra cost of eight cents for each package of not over four pounds.

Orders for over \$10 will be sent by express "C. O. D." if desired; but for smaller sums, parties will please remit the necessary amount with their order.

Write all letters legibly, give your Post-office, County and State, and be sure to sign your letter before mailing.

We are not responsible for loss of goods sent by mail.

Should any other works on kindred topics be desired, we will furnish them at publishers' prices.

Our prices for books are for the latest editions published.

ARCHITECTURE, CARPENTRY, AND BUILDING.

	PRICE.
BALDWIN, W. J. Steam-Heating for Private Houses and large Buildings. 12mo. Illustrated.....	\$2.50
BERG, W. G. Buildings and Structures of American Railroads. 4to. 534 pages. 700 illustrations.....	5.00
BULLOCK, J. Rudiments of Architecture and Building. 8vo. Illustrated.....	2.50
DOWNING, A. J. Cottage Residences. 8vo. 181 illustrations.	2.50
FREITAG, J. K. Architectural Engineering. With special reference to high building construction. 8vo. 239 pages. 120 illustrations.....	2.50
GOULD, L. D. Carpenters' and Builders' Assistant. 8vo.....	2.50
HATFIELD, R. G. The American House-Carpenter. 8vo.....	5.00
HURST, J. T. Hand-Book for Architectural Surveyors.....	2.00
KEMP, EDWARD. Landscape Gardening. 403 pages. 204 illustrations. 12mo.....	2.50
PALLISER'S Model Homes, showing a Variety of Designs for Model Dwellings. 8vo.....	1.00
REID, D. B. Ventilation of American Dwellings. 12mo.....	1.50
WOODWARD, G. E. Cottages and Farm Houses. 178 illustrations.....	1.00
WOODWARD, G. E. Suburban and Country Houses. 70 illustrations.....	1.00

ASTRONOMY.

BOWDITCH, N. American Practical Navigator. An Epitome of Navigation and Nautical Astronomy. 8vo.....	\$2.75
CHAUVENET, WM. Spherical and Practical Astronomy; and the Theory and Use of Fixed Astronomical Instruments. 2 vols. royal 8vo.....	7.00
LOOMIS, E. Practical Astronomy, with Astronomical Tables. Description of instruments required. Method of determining time, latitude, and longitude, with the computation of eclipses and occultations. For the use of amateur observers, practical surveyors and engineers. 505 pages. 37 tables. 8vo.....	2.00
NAUTICAL Almanac. Published by authority of the Secretary of the Navy, Washington. Each year.....	.75
NAUTICAL Almanac and Ephemeris. Large 8vo. Each year...	1.50
NEWCOMB, S. Popular Astronomy, with 112 engravings and 5 maps of the stars. 8vo.....	2.50
PROCTOR, R. A. Half-Hours with the Telescope. 12mo. Illustrated.....	1.25
PROCTOR, R. A. Half-Hours with the Stars. A plain and easy guide to the knowledge of the constellations, with explanation of each map. True for every year. Demy 4to.....	2.00

BRIDGES, ROOFS, ETC.

	PRICE.
BENDER, C. B. Principles of Economy in the Design of Metallic Bridges, including Cantilever Bridges. 195 pages. 12 plates.	\$2.50
BOLLER, A. P. Practical Treatise on the Construction of Iron Highway Bridges. Illustrated. 8vo.....	2.00
BUCK, G. W. A Practical and Theoretical Essay on Oblique Bridges. Revised by W. H. Barlow. 8vo.....	4.50
BURR, WM. H. Stresses in Bridges and Roof Trusses, Arched Ribs and Suspension Bridges. 475 pages. Illustrations and 13 plates. 8vo.....	3.50
FOSTER, W. C. Wooden Trestle Bridges, according to the present practice on American railroads. 4to.....	5.00
GREENE, C. E. Roof Trusses. Diagrams for Steady Load, Snow and Wind. 8vo.....	1.25
GREENE, C. E. Bridge Trusses. Single, Continuous and Draw-Spans; Single and Multiple Systems; Straight and Inclined Chords. 8vo.....	2.50
GREENE, C. E. Arches in Wood, Iron and Stone, for Roofs, Bridges and Wall openings; Arched Ribs and Braced Arches, Stresses from Wind and change of Temperature. 8vo. 190 pages. 60 illustrations.....	2.50
HAUPT, H. Bridge Construction. With practical illustrations. 8vo.....	3.50
HAUPT, H. Military Bridges; Designs for Trestle and Truss Bridges. 8vo.....	6.50
MERRILL, W. E. Iron Truss Bridges for Railways. With a comparison of the most prominent Truss Bridges. Illustrated. 4to.....	5.00
MERRIMAN, M. Text Book on Roofs and Bridges. Part 1. Stresses in Simple Trusses. 8vo.....	2.50
MERRIMAN, M. Text Book on Roofs and Bridges. Part 2. Graphic Statics. 8vo.....	2.50
MERRIMAN, M. Text Book on Roofs and Bridges. Part 3. Bridge Design. 8vo. 425 pages. 68 illustrations and 18 plates.....	2.50
SHREVE, S. H. Strength of Bridges and Roofs. With practical applications and examples for the use of Engineers. 89 cuts. 8vo.....	3.50
WADDELL, J. A. L. Practical Work on Iron Bridges for Highways. 8vo. Illustrated.....	4.00
WHIPPLE, S. Bridge Building. Practical Treatise on Iron and Wooden Bridges. 8vo. 352 pages. Illustrated.....	3.00
WOOD, DE VOLSON. Treatise on the Theory of the Construction of Bridges and Roofs. 8vo.....	2.00
WRIGHT, C. H., AND WING, C. B. Manual of Bridge Drafting. With folding plates and blue-print diagrams. 4to.....	4.00

CHEMISTRY, PHYSICS, ETC.

	PRICE.
ATTFIELD, J., Chemistry, General, Medical, and Pharmaceuti- cal. 12mo.....	\$2.75
BAYLEY, THOS. A Pocket-book for Chemists, Chemical Manu- facturers, Metallurgists, Dyers, Distillers, Brewers, etc. 32mo, oblong.....	2.00
CHURCH, A. H. The Laboratory Guide; Practical Chemistry for Colleges and Schools, especially arranged for Agricultural Students. 12mo.....	2.50
EISSLER, M. Modern High Explosives. Illustrated. 8vo.....	4.00
FLETCHER, E. L. Practical Instructions in Quantitative Assay- ing with the Blowpipe. 12mo.	1.50
FRESENIUS, C. R. Qualitative Chemical Analysis. New Edi- tion. Revised by Prof. S. W. Johnson. 8vo.....	3.00
FRESENIUS, C. R. Quantitative Chemical Analysis. Revised by Prof. O. D. Allen and Prof. S. W. Johnson. 900 pages. 8vo.....	6.00
GANOT-ATKINSON. Elementary Treatise on Physics, experi- mental and applied. 8vo.....	5.00
PEPPER, J. H. The Boys' Play-Book of Science, including the various Manipulations of Chemical and Philosophical Apparatus required for Scientific Experiments. Illustrated. 12mo.....	2.00
PLATTNER, T. H. Blowpipe Analysis. Illustrated. 560 pages. 8vo.....	5.00
PLYMPTON, G. W. The Practical use of the Blowpipe. 12mo. Illustrated.....	1.50
PRESCOTT, A. B. First Book in Qualitative Chemistry. 12mo	1.50

CONSTRUCTIONS, STRENGTH OF MATERIALS, ETC.

BAKER, I. O. Treatise on Masonry Construction. With 160 en- gravings, 87 tables. 8vo. 567 pages.....	\$5.00
BURR, WM. H. Elasticity and Resistance of the Materials of Engineering. 772 pages. 8vo. Illustrated.....	5.00
BYRNE, A. T. Highway Construction. The Location, Con- struction and Maintenance of Roads, Streets and Pavements. 696 pages. 249 illustrations. 90 tables. 8vo.....	5.00
CLARK, D. K. Tramways; their Construction and Working. 200 illustrations and 13 plates. 2 vols. 8vo.....	12.50
DUBOIS, PROF. A. J. Strains in Framed Structures. With numerous practical Applications to Cranes, Bridge, Roof and Suspension Trusses, Braced Arches, Pivot and Draw-Spans, Continuous Girders, etc. Fully illustrated. 4to. 540 pages,	10.00
GILLMORE, GEN. Q. A. Treatise on Limes, Hydraulic Ce- ments and Mortars. Papers on Practical Engineering, U. S. Engineer Department. 8vo. 334 pages.....	4.00

	PRICE.
HATFIELD, R. G. Theory of Transverse Strains, and its application to the Construction of Buildings, Iron Girders, Roofed Trusses, etc. 8vo.....	\$5.00
HOWE, M. A. Retaining-Walls for Earth. 12mo.....	1.25
HUNTINGTON, W. S. Roadmaster's Assistant and Sectionmaster's Guide.....	1.50
PATTON, W. M. Practical Treatise on Foundations. 400 pages. 21 plates. 8vo.....	5.00
JERVIS, J. B. Railway Construction and Management. 12mo...	2.00
JOHNSON, J. B. Theory and Practice in Designing Modern Framed Structures. 4to. 527 pages. 450 illustrations. 40 plates.....	10.00
SHIELDS, J. E. Notes on Engineering Construction, and description of the materials employed in Tunneling, Bridging, Canal and Road Building, etc. Illustrated. 12mo.....	1.50
SMITH, J. B. Cable Tramways, as applied to the working of Street and other Railways. Illustrated. 4to.....	2.50
SPALDING, F. P. Text-Book on Roads and Pavements. 12mo.	2.00
TRATMAN, E. E. R. Railway Track and Track-Work. 400 pages. 200 illustrations. 8vo.....	3.00
WOOD, DE VOLSON. Resistance of Materials, and an appendix on the Preservation of Timber. 8vo.....	2.00
WRIGHT, A. M. American Street Railways; their Construction, Equipment and Maintenance. 300 pages. 12mo.....	5.00

DRAWING.

ANDRE, G. G. Draughtsman's Hand-book of Plan and Map Drawing. With instructions for Engineering, Architectural and Mechanical Drawing. Illustrated. 33 plates. 8vo.....	\$3.75
ANTHONY, G. C. Elements of Mechanical Drawing. 98 pages of text and 32 plates.....	1.75
APPLETON'S Cyclopedia of Drawing. New edition, enlarged, 8vo.....	10.00
CHURCH, A. E. Elements of Descriptive Geometry, with its Applications to Spherical Projections, Shades and Shadows, Perspective and Isometric Projections. 8vo., and Atlas of Plates, 4to.....	3.50
COPLEY, F. S. Alphabets of all the Various Hands of Modern Use, with Examples in each style; also, the Mechanical and Analytical Construction of Letters, Figures and Titles. 47 plates. Oblong.....	2.00
CROMWELL, J. H. System of Easy Lettering.....	.50
ESSER. Draughtsman's Alphabets. Oblong.....	1.50
LIETZE, ERNST. Modern Heliographic Processes. Royal 8vo. Illustrated.....	3.00

	PRICE.
MAHAN, D. H. Industrial Drawing; Comprising the Description and Uses of Drawing-Instruments, the Construction of Plane Figures, the Projections and Sections of Geometrical Solids, Architectural Elements, Mechanism and Topographical Drawing. Revised by Prof. D. F. Thompson. 1 vol. 209 pages, and atlas of plates. 8vo. New edition.....	\$3.50
MAXTON, J. Workman's Manual of Engineering Drawing. 12mo.....	1.40
MINIFIE, WM. Mechanical Drawing, including an Introduction to Isometrical Drawing, and an Essay on Linear Perspective and Shadows, 200 illustrations. 8vo.....	4.00
MINIFIE, WM. Geometrical Drawing—an abridgment of "Mechanical Drawing." 12mo.....	2.00
REED, H. A. Topographical Drawing and Sketching, and Photography applied to Surveying. 205 pages. Illustrated and with 26 plates. 4to.....	5.00
REINHARDT, C. W. Lettering for Draughtsmen, Engineers and Students. 8vo. Oblong.....	1.00
ROSE, JOSHUA. Mechanical Drawing Self-Taught, Elementary Instruction in Practical Drawing. 330 illustrations. 8vo.....	4.00
SMITH, R. S. Manual of Topographical Drawing. Revised and enlarged by Chas. McMillan, C. E. Illustrated. 8vo.....	2.50
STANLEY, W. F. Mathematical Drawing-Instruments; with hints upon Drawing and Coloring. 12mo.....	2.00
TUTHILL, W. B. Practical Lessons in Architectural Drawing 8vo. Illustrated.....	2.50
WARREN, S. E. Drafting-Instruments and Operations. 12mo..	1.25
WARREN, S. E. Elements of Machine Construction and Drawing. 2 vols. 8vo. Text and plates.....	7.50
WARREN, S. E. Free-hand Drawing. 12mo.....	1.00
WARREN, S. E. General Problems of Shades and Shadows. 8vo.	3.00
WARREN, S. E. Manual of Projection Drawing. 12mo.....	1.50
WARREN, S. E. Manual of Linear Perspective. 12mo.....	1.00
WARREN, S. E. New Descriptive Geometry. 8vo.....	3.50
WARREN, S. E. Plane Problems in Elementary Geometry. 12mo.....	1.25

ELECTRICITY, TELEGRAPHY, ETC.

ATKINSON, P. Electric Lighting; including Electric Generation, Measurement, Storage and Distribution. 264 pages. 104 illustrations. 12mo.....	\$1.50
CLARK (LATIMER) AND SABINE (ROBERT). Electric Tables and Formulae for the Use of Telegraph Inspectors and Operators. Illustrated. 12mo.....	5.00
CROCKER, F. B. Electric Lighting; a Practical Treatise for Electricians and Students. 8vo. 437 pages. Illustrated.....	3.00

	PRICE.
CROCKER, F. B. AND WHEELER, S. S. Practical Management of Dynamos and Motors. 12mo. 210 pages. 100 illustrations.....	\$1.00
CROSBY, O. T. AND BELL, L. Electric Railway in Theory and Practice. 8vo. 400 pages. 179 illustrations.....	2.50
CULLEY, R. S. Hand-book of Practical Telegraphy. 8vo.....	5.50
FISKE, Lt. B. A. Electricity in Theory and Practice; elements of electrical engineering. 270 pages. 176 illustrations. 8vo.	2.50
KEMPE, H. R. Hand-book of Electrical Testing. 576 pages, 200 illustrations. 8vo.....	7.25
LOCKWOOD, T. D. Electricity, Magnetism and Electric Telegraphy. General Information for Electrical Students, Operators and Inspectors. 8vo. 378 pages. 152 illustrations.....	2.50
POPE, F. L. Modern Practice of Electric Telegraph. 8vo. Illustrated.....	1.50
PRESCOTT, G. B. Electricity and the Electric Telegraph. 2 vols. 8vo. Illustrated.....	7.00
SLOANE, T. O'C. Standard Electrical Dictionary. 624 pages. 350 illustrations. 12mo.....	3.00
SLOANE, T. O'C. Arithmetic of Electricity. 12mo.....	1.00
SLOANE, T. O'C. Electricity Simplified. Illustrated. 12mo...	1.00
SPRAGUE, J. T. Electricity; its Theory, Sources and Applications. New edition, with numerous illustrations. 647 pages,	6.00
URQUHART, J. W. Dynamo Construction. A Practical Handbook. 352 pages. 113 illustrations. 12mo.....	3.00

GEOLOGY, MINING AND METALLURGY.

BAUERMAN, H. Metallurgy of Iron. Outlines of the History of Iron Manufacture, Analysis of Iron Ores, etc. 12mo.....	\$2.00
BOWIE, A. J., JR. Practical Treatise on Hydraulic Mining, with Description of the Use and Construction of Ditches, Flumes, Wrought-iron Pipes and Dams; Flow of Water on Heavy Grades, and its Applicability, under High Pressure, to Mining. 313 pages. 72 illustrations. 52 tables. 8vo.....	5.00
DANA, J. D. Manual of Geology, treating especially of American Geological History. 8vo.....	6.00
DANA, J. D. Manual of Mineralogy, including Observations on Mines, the Reduction of Ores, etc. 12mo.....	2.00
DANA, J. D. Text-Book of Geology. 12mo.....	2.50
DANA, E. S. A System of Mineralogy. 8vo. 1425 illustrations. 1197 pages.....	12.50
IHLSENG, M. C. Manual of Mining, Mining Engineering, Practical Mining. 507 pages. 254 illustrations. 8vo.....	4.00
LARKIN, JAMES, Brass and Iron Founders' Guide. 12mo.....	2.50
OSBORN, H. S. Prospector's Field-Book and Guide. New Edition. 12mo. 296 pages. Illustrated.....	1.50

	PRICE.
OVERMANN, F. Practical Mineralogy, Assaying, Mining. 12mo. 230 pp.....	\$1.25
OVERMANN, F. A Treatise on Metallurgy ; Mining and Metal- lurgical Operations. 732 pages. 377 Engravings. 8vo.....	5.00
PHILLIPS, J. S. Explorers' and Assayers' Companion. Vol. I, Rocks, Veins, Testing and Assaying. 8vo.....	6.00
VAN WAGENEN, T. F. Manual of Hydraulic Mining, for the Use of the Practical Miner. 18mo.....	1.00
WILSON, E. B. Practical Mine Ventilation. 16mo. Illus.....	1.25

HYDRAULIC AND SANITARY ENGINEERING.

ADAMS, J. W. Sewers and Drains for Populous Districts. Rules and Formulas for the dimensions and construction of works of Sanitary Engineers. 8vo. 228 pages. Illustrated.....	\$2.50
BILLINGS, W. R. Details of Water-works Construction. 8vo. Illustrated	2.00
BOX, THOS. Practical Hydraulics; Rules and Tables for the Use of Engineers, etc. 12mo. 100 pages. 49 illustrations..	2.00
FANNING, J. T. A Practical Treatise on Water-Supply Engineer- ing; relating to the Hydrology, Hydrodynamics, and Practical Construction of Water-works in North America. 8vo. 650 pages. 200 illustrations. 121 tables.....	5.00
FRANCIS, JAS. B. Lowell Hydraulic Experiments on Hydraulic Motors, on the Flow of Water over Weirs, in Open Canals of Uniform Rectangular Section, and through Submerged Orifices and Diverging Tubes. Made at Lowell, Mass. 4to. Illus- trated	15.00
FRENCH'S Principles, Process and Effects of Draining Lands. Over 100 illustrations. 12mo.....	1.50
LEFFEL, JAS. Race and Reservoir Embankments and Head Gates, Gauging Water-Supply, Construction of Mill Dams, etc. 8vo.	2.50
MERRIMAN, M. Treatise on Hydraulics, Hydrostatics, Hydraul- ic Motors, etc. Numerous Tables and Diagrams. 384 pages. 109 illustrations. 25 tables. 8vo.....	4.00
RAFTER, G. W., AND BAKER, M. N. Sewage Disposal in the United States. 600 pages. Illustrated and plates. 8vo.....	6.00
STALEY-PIERSON. The Separate System of Sewerage. Theory and Construction. Illustrated. 8vo. 280 pages. 21 tables,	3.00
STEVENSON, D. Canal and River Engineering. Illustrated. 8vo.	10.00
STEVENSON, THOS. The Design and Construction of Harbors. Illustrated. 8vo.....	10.00
STEWART, H. Irrigation for the Farm, Garden and Orchard. Illustrated. 276 pages. 12mo.....	1.50

	PRICE.
WARING, G. E. Draining for Profit and Health. How to lay out and construct a system of drains. Illustrated. 12mo.....	\$1.50
WARING, G. E. Modern Methods of Sewage Disposal. 252 pages. Illustrated. 12mo.....	2.00
WARING, G. E. Sanitary Drainage of Houses and Towns. 12mo.....	2.00
WARING, G. E. Sewerage and Land Drainage. 406 pages, and 30 plates. Quarto.....	6.00
WEGMANN, E., JR. The Design and Construction of Masonry Dams. 126 pages and 70 plates. 14 tables. 4to.....	5.00
WILSON, H. M. Manual of Irrigation Engineering. Hydrography. Canals and Canal Work. Storage Reservoirs. 351 pages. 100 Illustrations. 8vo.....	4.00
WEISBACH, J. Hydraulics and Hydraulic Motors, with practical examples for the calculation and construction of Water-Wheels, and a discussion of the various forms of Turbines, translated from the fourth edition of Weisbach's Mechanics, by A. J. Du Bois. 380 engravings. 8vo.....	5.00

MACHINERY AND MECHANICS.

APPLETON'S Dictionary of Mechanics. 5,000 engravings. Large 8vo. 2 vols., sheep binding.....	\$15.00
BOURNE, JOHN. A Catechism of the Steam-Engine. 12mo....	2.00
BOURNE, JOHN. Hand-book of the Steam-Engine. A key to the "Catechism of the Steam-Engine." Illustrated. 12mo...	1.75
BROWN & SHARPE Mfg. Co. Gear Wheels and Gearing. Practical Treatise, with Tables. Illustrated. 8vo.....	1.00
CLARK, D. K. A Manual of Rules, Tables, and Data for Mechanical Engineers, based on the most recent investigations. Illustrated with numerous Diagrams. Large 8vo. 1012 pages.....	5.00
COOPER, J. H. Use of Belting for Transmission of Power. 8vo. Illustrated.....	3.50
FORNEY, M. N. Catechism of the Locomotive. 709 pages. 500 illustrations. 8vo.....	3.50
GOODEVE, T. M. Text-book on the Steam-Engine. 12mo, 143 illustrations.....	2.00
HEMENWAY, F. F. Indicator Practice and Steam-Engine Economy. 12mo.....	2.00
HUGHES, WM. C. American Miller and Millwright's Assistant. 12mo.....	1.50
ISHERWOOD, B. F. Engineering Precedents for Steam Machinery. Arranged in the most practical and useful manner for Engineers. Illustrated. 8vo.....	2.50
PRAY, THOS., JR. Twenty Years with the Indicator. 286 pages. 172 illustrations. 8vo.....	2.50

	PRICE.
ROPER, S. Hand-book of Land and Marine Engines, including their Modeling, Construction and Management. 12mo.....	\$3.50
ROPER, S. Hand-book of the Locomotive, including Construction and Management of Locomotive Engines and Boilers. 12mo.....	2.50
SCHUMANN, F. A Manual of Heating and Ventilation. Embracing a Series of Tables and Formulæ for dimensions of heating, flow and return pipes for steam and hot-water boilers, flues, etc. 12mo. Illustrated.....	1.50
THURSTON, R. H. Manual of Steam Boilers, their design, Construction and Operation. 8vo. 244 illustrations.....	5.00
THURSTON, R. H. Manual of the Steam-Engine. Part I. Structure and Theory. 8vo.....	6.00
THURSTON, R. H. Manual of the Steam-Engine. Part II. Design, Construction and Operation. 8vo.....	6.00
WEISBACH, J. Méchanics of Engineering and Machinery. 8vo. 800 illustrations.....	5.00

POCKET-BOOKS, TABLES, ETC.

ALLEN, C. F. Railroad Curves and Earthwork, with tables and diagrams.....	\$2.00
BOILLEAU, J. T. Traverse Tables; showing the difference of latitudes and the departures to every minute of the quadrant. 8vo.....	5.00
BRUHNS, DR. Manual of Logarithms to seven places of Decimals. 8vo.....	2.50
BURT, W. A. Key to the Solar Compass, and Surveyors' Companion. All the rules necessary for use in the field; Linear Surveys and Public Land System of the United States, Notes on the Barometer, suggestions for an outfit for a survey of four months, etc. 202 pp.....	2.50
BUTTS, EDWARD. Civil Engineers' Field-Book; designed for the Locating Engineer. With numerous tables.....	2.50
CLEVENGER, S. V. A treatise on the method of Government Surveying. With complete Mathematical, Astronomical, and Practical Instructions, for the use of United States Surveyors...	2.50
CRANDALL, C. L. Railway and other Earthwork Tables. 8vo.....	1.50
CROCKETT, C. W. Logarithmic and Trigonometric Tables.....	1.25
GODWIN, H. C. Railroad Engineers' Field-Book on Exploring, Location and Construction. 250 pp. 20 tables.....	2.50
GURDEN, R. L. Traverse-Tables; Computed to four places of decimals and for every minute of angle up to 100 of distance. Size 9 x 14, half morocco.....	7.50

	PRICE.
HAMILTON, W. G. Useful Information for Railway Men. 562 pp.	\$2.00
HASWELL, C. H. Engineers' and Mechanics' Pocket-Book. Tables, Rules and Formulas Pertaining to Mechanics, Mathematics and Physics, etc. 988 pp. 12mo.....	4.00
HENCK, J. B. Engineers' Field-Book. Containing formulæ for laying out Curves, determining Frog Angles, Leveling, calculating Earthworks. 273 pp. 17 tables.....	2.50
HODGMAN, F. Surveyors' Tables; being the 21 tables as printed in Hodgman's Manual of Surveying. 26mo. 106 pp.....	1.00
JOHNSON, J. B. Stadia and Earthwork Tables. 8vo.....	1.25
KENT, WM. Mechanical Engineers' Pocket-Book. 1088 pp. 12mo.....	5.00
KIDDER, F. E. Architects' and Builders' Hand-book. 1040 pp. 500 illustrations.....	4.00
MERRIMAN, M., and BROOKS, J. P. Hand-book for Surveyors. Land Surveying, Leveling, Triangulation, Topography, Tables.....	2.00
MOLESWORTH, G. L. Pocket-Book of Formulæ for Engineers. Revised.....	2.00
NYSTROM, J. W. Pocket-Book of Mechanics and Engineering.	3.50
SEARLES, WM. H. Field Engineering. Theory and Practice of Railway Surveying, Location, and Construction. 503 pp. 31 tables.....	3.00
SEARLES, WM. H. The Railroad Spiral. Theory of the Compound Transition Curve reduced to Practical Formulæ and Rules for Application in Field Work.....	1.50
SHUNK, W. F. The Field Engineer. A handy book of practice in the Survey, Location, and Track-work of Railroads, containing a large collection of Rules and Tables applicable to both the Standard and Narrow Gauge. 339 pp. 17 tables.....	2.50
SHUNK, W. F. Treatise on Railway Curves.....	2.00
STILES, A. Tables for Field Engineers. Designed for use in the field. Tables containing all the functions of a one degree curve, from which a corresponding one can be found for any required degree, also tables of natural sines and tangents. 8vo.	2.00
TRAUTWINE, J. C. Excavations and Embankments. 8vo.....	2.00
TRAUTWINE, J. C. Railroad Curves. 192 pp. 14 tables.....	2.50
TRAUTWINE, J. C. Civil Engineer's Pocket-Book of Mensuration, Trigonometry, Surveying, Hydraulics, Hydrostatics, Strength of Materials, Masonry, Principles of Wooden and Iron Roof and Bridge Trusses, Stone Bridges and Culverts, Trestles, Pillars, Suspension Bridges, Dams, Railroads, Turnouts, Turning Platforms, Water Stations, Cost of Earthwork, Foundations, Retaining Walls, etc. 866 pp.....	5.00
VEGA, BARON VON. Logarithmic Tables. 8vo. 575 pp.....	2.50
WADDELL, J. A. L. De Pontibus. A Pocket-Book for Bridge Engineers, with tables and plates.....	3.00

SURVEYING AND ENGINEERING.

See also Pocket-Books, Tables, etc.

	PRICE.
BROUGH, B. H. Treatise on Mine Surveying. For Managers of Mines and Collieries. 8vo. Illustrated. 302 pp.....	\$2.50
CLARK, J. M. New System of laying out Railway Turnouts. 12mo.	1.00
CLEEMAN, T. M. Railroad Engineer's Practice. Illustrated. 12mo	1.50
DAVIES, CHAS. Elements of Surveying and Leveling; Topography, Railway Curves, and Mining Surveying. 12mo.....	2.50
DORK, B. F. The Surveyors' Guide and Pocket Table-Book. The Rules cover every case likely to occur in a surveyor's practice, and are based on United States laws, and have the written approval of the Commissioner of the General Land Office	2.00
GILLESPIE'S SURVEYING. New edition in two parts. Part I. Land-Surveying and Direct Leveling. 8vo. 551 pages. Illustrated	2.50
GILLESPIE'S SURVEYING. New edition. Part II., Higher Surveying. 467 pages. Illustrated.....	2.50
GILLESPIE, W. M. Principles and Practice of Road-Making. 12mo	2.50
GILLMORE, GEN. Q. A. Practical Treatise on the Construction of Roads, Streets and Pavements. 12mo. 258 pp. 70 illustrations.....	2.00
HAUPT, L. M. Engineering Specifications and Contracts. Text-book and Work of Reference. 8vo. Illustrated.....	3.00
HAUPT, L. M. The Topographer; his Instruments and Methods. Fully illustrated. 8vo.....	3.00
HODGMAN, F. Manual of Land-Surveying, giving the law and the practice. The law is from the Statute Books of the United States and about 160 decisions from the highest courts in the land; the Practice is from the best authorities. 503 pp. 21 tables	2.50
JEFFERS, W. N. Treatise on Nautical Surveying. 8vo. Illustrated	5.00
JOHNSON, J. B. Engineering Contracts and Specifications. 420 pp. 8vo. Illustrated.....	3.00
JOHNSON, J. B. Text-Book of Surveying, Land and Railroad Surveying. Hydrography, Geodetic and Mining Surveying. 754 pp. Illustrated. 8vo.....	4.00
MAHAN, D. H. A Treatise on Civil Engineering. 8vo. Revised by De Volson Wood.....	5.00
PHELPS, H. Practical Marine Surveying. 8vo.....	2.50

	PRICE.
PLANE-TABLE, and its use in Topographical Surveying. From the papers of U. S. Coast Survey. Illustrated. 8vo.....	\$ 2.00
RANKINE, W. J. M. Civil Engineering, comprising Engineering Surveys, Earthwork, Foundations, Masonry, Carpentry, Metal-Works, Roads, Railways, Canals, Rivers, Water-works, Harbors, etc., with tables and illustrations. 8vo. London.....	6.50
RAYMOND, W. G. Text-Book of Plane Surveying. 8vo. 485 pp. Illustrated.....	3.50
ROBINSON'S Surveying and Navigation. With use of instruments, essential Elements of Trigonometry, Mensuration, and the necessary Tables. Edited by Oren Root, A. M. 8vo.....	2.25
SIMMS, F. W. A Treatise on the Principles and Practice of Leveling. With Law's method of laying out Curves. 8vo. 215 pp.....	2.50
VOSE, GEO. L. Hand-Book of Railroad Construction, with plans, maps, etc. A complete hand-book of railway construction.....	12.50
WELLINGTON, A. M. The Economic Theory of the Location of Railways. 980 pp. 313 engravings, 204 Tables. 8vo.....	5.00
WELLINGTON, A. M. Railway Earthworks, with Diagrams. 2 vols. Illustrated.....	4.00
WILSON, H. M. Topographic Surveying, including Geographic, Exploratory and Military Surveys, Mapping, Camping, Photography, etc. 8vo. 900 pages. Illustrated.....	3.50

TREATISES ON INSTRUMENTS, ETC.

BAKER, I. O. Engineers' Surveying-Instruments. 400 pp. 86 illustrations. 12mo.....	\$3.00
COX, WM. Slide-Rule Manual.....	.56
CROCKETT, C. W. Explanation of Mannheim Slide-Rule.....	.75
GURLEY, W. & L. E. Manual of the Principal Instruments used in American Engineering and Surveying. Latest edition, revised. 440 pp. Fully illustrated.....	.50
HOARE, C. The Slide-Rule, and How to Use It. With a slide-rule in tuck of cover.....	1.00
HULME, F. E. Mathematical Drawing-Instruments, and how to use them. 12mo. 152 pp. 70 illustrations.....	1.50
LANKESTER, EDWIN. Half-Hours with the Microscope.....	2.00
NUGENT, E. Treatise on Optics. 12mo. 103 illustrations.....	1.50

	PRICE.
SLIDE-RULES. A General Treatise.....	\$1.00
SLIDE-RULE MANUAL for the Duplex and Mannheim Slide-Rules75
STANLEY, W. F. Surveying and Leveling-Instruments. Theoretically and practically described. 12mo. 552 pp. 345 illustrations.....	3.00

MISCELLANEOUS.

ALEXANDER, J. H. Weights and Measures, Ancient and Modern, reduced to Standard of the United States. 8vo.....	\$3.50
BENJAMIN, PARK. Engineers' and Mechanics' Recipes. 12mo. 300 pp.....	2.00
CHAUVENET, W. Plane and Spherical Trigonometry. 8vo.....	1.60
CHAUVENET, W. Treatise on Elementary Geometry. 8vo.....	1.75
CLARKE, D. K. Fuel; its Combustion and Economy. 12mo...	1.50
CRAIG, B. F. The Decimal System of Weights and Measures....	.50
CROCKETT, C. W. Elements of Plane and Spherical Trigonometry, with Tables.....	1.50
DAVIES, C. Analytical Geometry and Elements of Calculus. 8vo. In one vol.....	2.25
DAVIES, C. Metric System.....	1.00
GREGORY, O. Mathematics for Practical Men. For Engineers, Surveyors and Architects. 8vo.....	3.00
KNIGHT, E. H. American Mechanical Dictionary; a Description of Tools, Instruments, Machines and Engineering, etc. 4 vols. 8vo. Illustrated.....	27.50
LIPPINCOTT'S Pronouncing Gazetteer of the World. 4to, sheep.	12.00
ROBINSON'S Geometry and Trigonometry. 8vo.....	2.25
SPON, E. Workshop Receipts. 12mo. Each \$2.00; or complete in 5 vols.....	10.00
WEBSTER'S Unabridged Dictionary. 4to, sheep.....	12.00

SCIENCE SERIES.

18MO. FANCY BOARDS, 50 CENTS EACH.

- No.
- 1.—Chimneys for Furnaces, Fire Places, and Steam Boilers. By R. Armstrong, C. E.
 - 3.—Practical Designing of Retaining Walls. By Arthur Jacob, C. E.
 - 4.—Proportion of Pins Used in Bridges. By Chas. E. Bender, C. E.
 - 5.—Ventilation of Buildings. By W. F. Butler.
 - 6.—Designing and Construction of Reservoirs. By A. Jacob, A. B.
 - 7.—Surcharged and Different Forms of Retaining Walls. By Jas. S. Tate, C. E.
 - 11.—Theory of Arches. By Prof. W. Allan.
 - 12.—Theory of Voussoir Arches. By Prof. W. E. Cain.
 - 13.—Gases met with in Coal Mines. By J. J. Atkinson.
 - 14.—Friction of Air in Mines. By J. J. Atkinson.
 - 15.—Skew Arches. By Prof. E. W. Hyde.
 - 17.—Water and Water Supply. By Prof. W. H. Corfield.
 - 18.—Sewerage and Sewage Utilization. By Prof. W. H. Corfield.
 - 19.—Strength of Beams under Transverse Loads. By Prof. W. Allan.
 - 20.—Bridge and Tunnel Centers. By John B. McMaster, C. E.
 - 22.—High Masonry Dams. By John B. McMaster, C. E.
 - 23.—Fatigue of Metals under repeated Strains. From the German of Prof. Spangenburg, with a Preface by S. H. Shreve, A. M.
 - 25.—Theory and Calculation of Continuous Bridges. By M. Merriman, Ph. D.
 - 26.—Practical Treatise on Continuous Bridges. By Charles Bender, C. E.
 - 31.—Sanitary Condition of Dwelling Houses. By Geo. E. Waring, Jr.
 - 32.—Cable Making of Suspension Bridge. By Hildenbrand, C. E.
 - 33.—Mechanics of Ventilation. By Geo. W. Rafter, C. E.
 - 34.—Foundations. By Prof. Jules Gaudard, C. E.
 - 35.—Aneroid Barometer: Its Construction and Use. By Geo. W. Plympton.
 - 37.—Geographical Surveying. By Frank De Yeaux Carpenter, C. E.
 - 38.—Maximum Stresses in Frame Bridges. By Prof. W. E. Cain, A. M.
 - 40.—Transmission of Power by Compressed Air. By R. Zahner, M. E.
 - 41.—Strength of Materials. By Wm. Kent, C. E.
 - 42.—Voussoir Arches Applied to Stone Bridges, Tunnels, Culverts, Groined Arches and Domes. By Prof. W. E. Cain, C. E.
 - 44.—Turbine Wheels. By Prof. W. P. Trowbridge.
 - 45.—Thermodynamics. By Prof. H. T. Eddy.
 - 48.—Theory of Solid and Braced Arches. By W. E. Cain, C. E.
 - 50.—Dwelling Houses; their Sanitary Construction and Arrangements. By Prof. W. H. Corfield.

- No.
- 55.— Sewer Gases; their Nature and Origin. By A. de Varona.
- 56.— Actual Lateral Pressure of Earthwork. By Benj. Baker, C. E.
- 58.— Ventilation of Coal Mines. By W. Fairley.
- 59.— Railroad Economics. By S. W. Robinson, C. E.
- 60.— Strength of Wrought Iron Bridge Members. By S. W. Robinson, C. E.
- 61.— Potable Water: and Methods of Detecting Impurities. By Chas. W. Folkard.
- 63.— House Drainage and Sanitary Plumbing. By W. P. Gerhard, C. E.
- 65.— Pocket Logarithms to Four Places of Decimals.
- 67.— Hydraulic Tables. By P. J. Flynn, C. E.
- 72.— Topographical Surveying. By Geo. J. Specht, Prof. A. S. Hardy, John B. McMaster and H. F. Walling.
- 74.— Testing Machines, their History, Construction and Use. By Arthur V. Abbott.
- 77.— Stadia Surveying and Stadia Measurements. By A. Winslow.
- 80.— Healthy Foundations for Houses. By Glenn Brown.
- 81.— Water Meters: Comparative Tests of Accuracy, Delivery, etc. By Ross E. Browne.
- 82.— Preservation of Timber by the Use of Antiseptics. By S. B. Boulton, C. E.
- 83.— Mechanical Integrators. By Prof. Henry S. H. Shaw, C. E.
- 84.— Flow of Water in Open Channels, Pipes, Conduits, Sewers, etc.; with Tables. By P. J. Flynn, C. E.
- 87.— Treatise on the Theory of the Construction of Helicoidal Oblique Arches. By John L. Culley, C. E.
- 88.— Beams and Girders. Formulas for their Resistance. By Prof. P. H. Philbrick.
- 91.— Leveling; Barometric, Trigonometric, and Spirit. By Prof. I. O. Baker.
- 93.— Notes Embodying Recent Practice in the Sanitary Drainage of Buildings. By Wm. Paul Gerhard, C. E.
- 94.— Treatment of Sewage. By Dr. C. Meymott Tidy.
- 95.— Plate Girder Construction. By Isami Hiroi, C. E.
- 100.— How to Become an Engineer. By G. W. Plympton, C. E.
- 101.— The Sextant and other Reflecting Mathematical Instruments. By F. R. Brainard, U. S. Navy.
- 104.— Van Nostrand's Table Book for Civil and Mechanical Engineers. Compiled by Prof. Geo. W. Plympton.
- 107.— Graphical Method for Swing-Bridges. By B. F. La Rue, C. E.
- 110.— Transition Curves. By W. G. Fox.

Any of the "Science Series" not mentioned in the above list will be furnished promptly on application.

57

THE RENSSELAER
POLYTECHNIC INSTITUTE
TROY, N. Y.

A SCHOOL OF ENGINEERING AND SCIENCE.

FOUNDED IN 1824.

It is the aim of the Institute to maintain the most thorough course of engineering in this country. Its methods of instruction are the result of an experience unequaled by that of any similar school in the world. The Course of Study pursued, while not beyond the capacity of young men of average ability, is constantly adjusted to the progress of the engineering profession. Its purpose is to equip students to enter upon a general engineering practice and to specialize later as opportunities open before them. That the plan has been attended with unqualified success is shown by the Register issued annually, containing the business address of each living graduate. Among them will be found men eminent in every branch of engineering. It is, moreover, the method of instruction pursued for other professions.

It should be stated, perhaps, that Civil Engineering is understood to include instruction in Mechanics and Dynamics, Road and Bridge Construction, Hydraulics, Steam and Electricity, Mining Engineering and Assaying.

The studies of the course are designed as a professional preparation, at once thorough and practical, for the following specialties of engineering practice :

The location, construction, and superintendence of public works, as steam and electric railways, canals, water works, etc.; the design, construction and management of mills, iron works, steel works, chemical works, and pneumatic works; the design and construction of roofs, arch bridges, girder bridges, and suspension bridges; the survey and superintendence of hydraulic motors, air engines, electric motors, and the various kinds of steam engines; the design, construction and use of machines in general, and the determination of their efficiency; the survey of rivers, lakes and harbors, and the direction of their improvements; the determination of latitude, longitude, time and the meridian in geographical explorations, or for other purposes, together with the projection of maps; the selection and test of materials used in construction; the construction of the various kinds of geometrical and topographical drawings.

The only Engineering degree conferred by the Institute is that of Civil Engineer, which has value peculiar to itself.

A course of study is also pursued in the Institute embracing more advanced instruction in Natural History, Chemistry and Geology, leading to the degree of Bachelor of Science. The first two years are identical with the course in Civil Engineering.

Special students in all courses, particularly in chemistry and electrical engineering, are also received.

The expenses of the course are \$100 at the opening of the two annual sessions for tuition. Other expenses are largely within the control of individual students. Every effort is made by the management to keep necessary expenses within the narrowest limits, consistent with the best opportunities to students, and they have been materially reduced within the last few years.

Any one desiring a thorough course of study in prepa-

ration for advanced professional work in any department of engineering is invited to apply for further information to the President of the Institute.

“The greatest number of the renowned hydraulic and railroad engineers of America are graduates of this school.”—*From the report to his government of Professor A. Riedler of the Royal Polytechnicum, at Berlin. (Report U. S. Commissioner of Education 1892-'93.)*

This famous Institute is by no means local, as the freshman list this year contains the names of students from twenty-two States of the Union, as well as from Cuba and South America, and the graduates are leading men in engineering and in business all over the world.—*The Railroad Gazette, February 22, 1901.*

TABLE OF CONTENTS.

	PAGE.
Abney Level and Clinometer.....	214, 215, 269
Adjustment of Architects' Level.....	165
Adjustment of Drainage Level.....	169
Adjustment of Engineers' Y-Level.....	155-162
Adjustment of Engineers' and Surveyors' Transits.....	19-24
Adjustment of Line of Collimation.....	19-22, 157
Adjustment of Object-glass Slide.....	23, 24, 155, 156
Adjustment of Solar Attachment.....	82-85
Adjustment of Solar Compasses.....	94, 130
Adjustment of Surveyors' Compasses.....	110
Adjustment of Telescopic Sight.....	121-123
Air-Meters.....	400-402
Alidades for Plane-Tables.....	189, 196, 197, 266-268
Alt-Azimuth.....	389
Aluminum Instruments.....	146, 236, 260
Anemometers.....	400-402
Aneroid Barometers.....	396-399
Angle-Mirrors.....	392
Architects' Levels.....	163-167, 261
Artificial Horizon.....	392
Astronomical Telescopes.....	406
Astronomical Terms.....	86-91
Attachments and Extras for Compasses.....	120-126, 257-259, 263
Attachments and Extras for Transits.....	25, 48-70, 255, 256
Ball-Spindle.....	104, 118, 257
Barometers, Aneroid.....	396-399
Battery for Current-Meters.....	204, 269
Blowpipes.....	412
Blue-Print Paper, Print-Frames and Bath-Trays.....	359-361
Books (blank) for Field-Notes.....	368-370
Books, Scientific, for Architects, Draftsmen, Engineers and Surveyors.....	336, 415-430
Boxes and Cases for Compasses, Levels and Transits.....	240, 241
Boxes and Cases for Drawing-Instruments.....	288, 301, 323, 381
Boxwood Rules and Scales.....	329-337
Bristol-Board.....	356
Bronze Finish.....	222, 239
Brushes for Water-Colors.....	382, 383
Builders' Transit.....	44, 45, 255

	PAGE.
Celluloid or Amber Goods	325, 326, 339, 340, 342, 345, 346
Center-Pin	115
Chains, American.....	223-226, 270
Chains, Metric and Vara	226, 271
Chain-Tapes	227, 228, 272
Clamp and Tangent.....	13, 14, 52, 54, 255, 258, 259, 266
Clinometers	140, 141, 214, 215, 260, 386, 394, 395
Colors, Winsor & Newton's.....	377, 379-381
Compass Attachment for Levels.....	148, 169, 261
Compasses, Clinometer.....	140, 141, 260, 386
Compasses, Dial.....	144-146, 260
Compasses, Extras for.....	120-126, 257-259, 263
Compasses, Geologists'	139, 260, 388
Compasses, Miners' Dip-Needle	142, 143, 260
Compasses, Plain.....	117-119, 257, 259
Compasses, Pocket	128-146, 148, 258-260, 386-390
Compasses, Prismatic.....	389, 390
Compasses, Railroad.....	99-103, 131-134, 257-259
Compasses, Solar.....	93-98, 128-130, 256, 258
Compasses, Vernier	104-116, 135-138, 257, 259
Compound Tangent Ball-Spindle.....	118
Crayon Pencils and Lumber Crayons.....	371, 372
Cross-Section Books and Paper.....	362-366, 370
Cross-Staff Heads.....	392
Cross-Wires.....	8, 9, 238, 241
Current-Meters.....	199-209, 269
Current-Meter Reduction-Tables.....	205, 206, 208, 209
Curves of Amber, Rubber and Wood.....	351, 352
Déclination Arc	62, 83, 129
Declination of Magnetic Needle.....	108-110
Declination of the Sun.....	65, 69, 71-76, 87
Detachable Telescopes for Transits.....	57, 256
Diagonal Prism for Eyepiece of Telescopes.....	58, 256
Dial Compasses.....	144-146, 260
Dip-Needle Compasses	142, 143, 260
Diurnal Variation	110
Drainage Levels	168-170, 261
Drawing-Boards and Tables.....	267, 268, 343, 344
Drawing-Instruments, Alteneder.....	296-301
Drawing-Instruments, Brass	316, 317, 326
Drawing-Instruments, German	302-315, 325
Drawing-Instruments, Nickel-plated.....	318-320
Drawing-Instruments, Pivot-Joint.....	291-301, 313
Drawing-Instruments, Swiss	280-295, 321-323
Drawing-Paper.....	356-360, 362-366
Dust-Guard for Object-glass Slide of Telescopes.....	12, 256

	PAGE.
Electric Register.....	200, 204, 269
Electricity.....	114
Ellipses.....	352
Empty Cases for Instruments.....	240, 241, 288, 301, 323, 381
Engineers' Levels.....	148-170, 261
Engineers' Transits.....	6, 25-32, 251-253
Erasing-Knives and Erasing-Rubber.....	373-375
Excavation and Embankment Tables.....	370, 424, 425
Extras for Compasses.....	257-259, 263
Extras for Transits.....	25, 48-70, 255, 256
Eyepiece of Telescope, how composed.....	5-7
Eyepiece for Transit and Level Telescopes.....	5, 7, 240, 241
Field-Glasses and Telescopes for Tourists.....	403-406
Flagstaff or Ranging-Pole.....	187, 265
Foreign Shipments.....	235
Geologists' Compass.....	139, 260, 388
Gradienter.....	55, 56, 256
Graduations of Limb and Vertical Circle.....	16, 49, 51, 256
Hand-Levels.....	212-215, 269
Hook-Gauge, Boyden's.....	210, 211, 269
Hour-Circle and Hour-Arc.....	62, 85, 130, 260
Hydrometers.....	414
Hygrometer.....	413
Hyperbolas.....	352
India Ink.....	377, 378
Information to Purchasers.....	230-241, 278, 279, 415
Ink-Slabs and Color-Saucers.....	383, 384
Ink, for Drawing or Writing.....	367, 377, 378
Inverting Eyepiece.....	7
Ivory Rules and Scales.....	328-330
Lacquering.....	222
Latitude Arc.....	62, 80-82, 129, 256
Latitude-Level.....	79, 80, 256
Leather Cases and Pouches.....	176, 263
Level on Telescope.....	52, 53, 255, 258
Level-Vials and Spirit-Levels.....	14, 19, 105, 111, 115, 152, 153, 158, 240, 241, 410, 411
Leveling-Adopter.....	118, 138, 257, 259
Leveling-Instruments, Architects' Levels.....	163-167, 261
Leveling-Instruments, Drainage.....	168-170, 261
Leveling-Instruments, Y-Levels.....	148-167, 261
Leveling-Rods.....	177-187, 263

	PAGE.
Leveling Tripod Head.....	16, 17, 119, 154, 256, 257, 259
Line of Collimation	19-22, 157
Locke's Hand-Level.....	214, 269
Magnetic Needle.....	12, 13, 66, 111, 114, 115
Magnets	412
Magnifiers	54, 256, 407-409
Magnifying Power of Telescopes.....	7, 8
Marking-Pins and Timber-Scribe.....	227, 271
Metric Aneroid Barometers.....	397
Metric Chains and Tapes	226, 229, 271, 273, 275, 276
Metric Leveling-Rods and Poles	186
Metric Paper for Draftsmen.....	362, 364-366
Metric Rules and Scales.....	332-334, 338
Miners' Dip-Needle Compasses	142, 143, 260
Miscellaneous	241, 428
Mountain Transits... ..	29-32, 252, 253
Mucilage	376
Object-glass of Telescopes.....	5, 240, 241
Odometers	216-221, 269
Offset-Standard	124, 126, 258
Oilstones.....	411
Opera and Field-Glasses.....	403, 404
Optical Axis.....	9, 123
Optical Principles of Telescope.....	5, 7
Outkeeper	107
Packing, etc.....	233
Pantographs	355
Paper-Cutter	367
Paper, Drawing and Tracing.....	356-360, 362-366
Parabolas	352
Parallel Rulers	354, 355
Parchment-Paper.....	358, 359
Parts of Instruments liable to injury, prices of	240, 241
Passometers	393
Payment, Terms of.....	234, 239
Pedometers	393
Pencils.....	371
Pencil-Sharpener	373
Pens, Mapping and Writing.....	372
Plain Compasses	117-119, 138
Plane-Tables.....	189-198, 266-268
Planimeters.....	288, 289
Platinum Cross-Wires.....	9, 238, 241
Plummet-Lamp.....	59, 256
Plummets	262

	PAGE.
Pocket-Compasses	128-146, 148, 258-260, 386-390
Pocket-Levels	410
Polar Axis	84
Price-List	240, 241, 251-430
Prismatic Compasses.....	389, 390
Profile-Books and Paper.....	363, 364, 368
Protractors of Boxwood, Brass, Celluloid, German Silver, Horn, Ivory, Paper, Rubber and Wood.....	321-328
Protractors, Limb, long steel blade.....	323, 324
Quick-Leveling Attachment.....	60, 256
Rack and Pinion.....	152, 256, 259
Railroad Compasses.....	99-103, 131-134, 257-259
Rain-Gauges.....	414
Ranging-Poles.....	187, 265
Reading-Glasses and Magnifiers.....	407-409
Reconnaissance Transit.....	42, 43, 254
Reflecting Mirrors and Prisms.....	392
Reflectors for Cross-Wires and Limb of Transits.....	16, 58, 256
Refraction.....	71-74, 90
Refractions, Table of.....	72-74
Rensselaer Polytechnic Institute.....	431-433
Repairs to Instruments.....	114, 236-239
Rod-Level.....	188, 265
Rods, Leveling.....	177-187, 264, 265
Rubber Goods.....	241, 326, 339-341, 346, 348, 351-353, 373-375
Scales of Boxwood, Ivory, Paper and Metal.....	328-338
Section-Liners.....	349, 350
Selection of Instruments.....	230
Sextants.....	391
Shifting Center for Leveling-Head of Transits.....	17
Sights on Standards and on Telescope of Transits.....	54, 256
Sizes of Compasses.....	103, 116, 117, 134, 136, 138
Sizes of Levels.....	163
Sizes of Transits.....	27, 36, 39, 47
Slide-Rules.....	336, 337
Slope-Levels.....	215, 269, 394, 395
Sockets of Levels.....	154
Sockets of Transits.....	14, 16, 29, 33, 35, 37, 39
Solar Attachment for Transits.....	61-71, 78, 79, 82-85, 256
Solar Compasses.....	93-98, 128-130, 256, 258
Solar Screen.....	70
Solar Transits.....	27, 28, 31, 40, 41, 81
Special Notices.....	4, 279, 415
Spirit-Levels.....	410, 411
Spring-Balance for Chains and Tapes.....	275

	PAGE.
Stadia Rods	184, 264
Stadia Wires	10, 11, 238-241
Staff Mountings	105
Steel Rules	338
Steel Tapes.....	272, 274-276
Stencil-Alphabets and Figures.....	384, 385
Straight-Edges of Amber, Rubber, Wood and Steel.....	338-340
Striding-Level	84, 85, 256
Surveyors' Cross-Staff Head.....	392
Surveyors' Transits	33-47, 253-255
Tables, Drawing.....	343
Tables, Plane.....	189-198, 266-268
Tables, Traverse	268, 424, 425
Tacks for Drawing-Boards.....	367
Tally-Register	393, 394
Tangent Scale on Sight-Vanes.....	105
Tape-Lines, Metallic.....	228, 273
Tape-Lines, Steel	228, 229, 272-276
Telescope, how composed.....	5-8, 148
Telescopes and Tourists' Glasses.....	404-406
Telescopes for Vertical Sighting.....	57, 256
Telescopic Sight Attachment.....	120-126, 258
Thermometers.....	275, 412, 413
Timber-Scribe, or Marking-Iron.....	271
Time-Recorder for Current-Meters.....	269
Tracing-Cloth and Paper.....	359
Trammel Points.....	411, 412
Transit-Instruments, Remarks on	5-24
Transits, Attachments for.....	25, 48-70, 255, 256
Transits, Builders'	44, 45, 255
Transits, Engineers'.....	6, 25-33, 251-253
Transits, Light Mountain and Mining.....	29-32, 252, 253
Transits, Reconnoissance.....	42, 43, 254
Transits, Solar	27, 28, 31, 40, 41, 252-254
Transits, Solar Attachment for.....	61-71, 78, 79, 82-85, 256
Transits, Surveyors'	33-47, 253-255
Transits, Vernier.....	46, 47, 255
Traverse-Tables.....	244-249, 424, 425
Traverse-Table Board and Tripod	197, 198, 268
Trial of Instruments	232
Triangles of Amber, German Silver, Rubber, Steel and Wood...	345-348
Tripods.....	172-175, 261, 262, 406
T-Squares of Amber, Rubber, Steel and Wood	340-342
Vara Chains and Tape-Lines.....	226, 229, 271
Variation Arc of Transits.....	13, 27, 255
Variation of the Needle.....	108-110

	PAGE.
Vellum or Tracing-Cloth.....	359
Verniers.....	15, 108
Vernier Compasses.....	104-116, 135-138, 259
Vernier Protractors.....	322-324
Vernier Transit-Compasses.....	46, 47, 255
Vertical Arc and Vertical Circle.....	49-51, 255, 258
Warranty.....	231
Water-Colors.....	377, 379-381
Water-Glasses.....	383
Weights of Compasses.....	98, 103, 116, 118, 134, 136
Weights of Levels.....	163
Weights of Transits.....	27, 32, 36, 39, 42, 45, 47
Writing-Ink, Paper and Pens, etc.....	366, 367, 372

