



This is a digital copy of a book that was preserved for generations on library shelves before it was carefully scanned by Google as part of a project to make the world's books discoverable online.

It has survived long enough for the copyright to expire and the book to enter the public domain. A public domain book is one that was never subject to copyright or whose legal copyright term has expired. Whether a book is in the public domain may vary country to country. Public domain books are our gateways to the past, representing a wealth of history, culture and knowledge that's often difficult to discover.

Marks, notations and other marginalia present in the original volume will appear in this file - a reminder of this book's long journey from the publisher to a library and finally to you.

Usage guidelines

Google is proud to partner with libraries to digitize public domain materials and make them widely accessible. Public domain books belong to the public and we are merely their custodians. Nevertheless, this work is expensive, so in order to keep providing this resource, we have taken steps to prevent abuse by commercial parties, including placing technical restrictions on automated querying.

We also ask that you:

- + *Make non-commercial use of the files* We designed Google Book Search for use by individuals, and we request that you use these files for personal, non-commercial purposes.
- + *Refrain from automated querying* Do not send automated queries of any sort to Google's system: If you are conducting research on machine translation, optical character recognition or other areas where access to a large amount of text is helpful, please contact us. We encourage the use of public domain materials for these purposes and may be able to help.
- + *Maintain attribution* The Google "watermark" you see on each file is essential for informing people about this project and helping them find additional materials through Google Book Search. Please do not remove it.
- + *Keep it legal* Whatever your use, remember that you are responsible for ensuring that what you are doing is legal. Do not assume that just because we believe a book is in the public domain for users in the United States, that the work is also in the public domain for users in other countries. Whether a book is still in copyright varies from country to country, and we can't offer guidance on whether any specific use of any specific book is allowed. Please do not assume that a book's appearance in Google Book Search means it can be used in any manner anywhere in the world. Copyright infringement liability can be quite severe.

About Google Book Search

Google's mission is to organize the world's information and to make it universally accessible and useful. Google Book Search helps readers discover the world's books while helping authors and publishers reach new audiences. You can search through the full text of this book on the web at <http://books.google.com/>

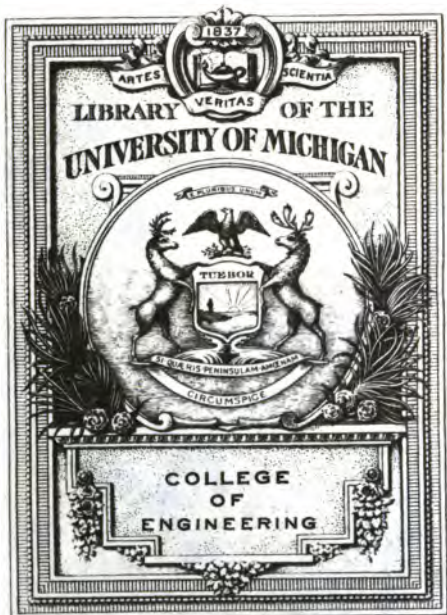

THE GIFT OF
H. B. Merriek





ENGINEERING
LIBRARY

TA

581

,G98

1912



•

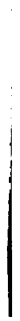

1110 N. C. E.

A MANUAL
OF THE PRINCIPAL
INSTRUMENTS

USED IN
AMERICAN ENGINEERING
[AND SURVEYING]

Handwritten signature

MANUFACTURED BY
W. & L. E. GURLEY
TROY, N. Y., U. S. A.

FORTY SIXTH EDITION
PRICE, 50 CENTS

TROY, N. Y.
PUBLISHED BY
W. & L. E. GURLEY
MAY, 1912

Entered, according to Act of Congress, in the Year 1911
By W. & L. E. GURLEY
In the Office of the Librarian of Congress, at Washington
Copyright, 1912,
By W. & L. E. GURLEY









Engine lit
544
H. B. McNeill
6-2-33

GURLEY'S *Manual*
is primarily a book of
instructions in the ad-
justment and use of
field instruments.

*Simplicity of expression
is sought and no attempt
is made at treatises which
are more properly to be
found in technical pub-
lications.*

ESTABLISHED 1845.

INCORPORATED 1900.

PREFACE TO THE FORTY SIXTH EDITION

THIS edition of our Manual supersedes all previous editions and contains descriptions and illustrations of our most recent improvements. For more than sixty years the manufacture of Civil Engineers and Surveyors instruments has been conducted in the present location by William and Lewis E. Gurley and their immediate descendants.

Improvements in construction and methods have been made and we have now as complete an equipment for the manufacture of our special products as can be found and we have been for many years the most extensive manufacturers in our line in the world.

We supply only warranted instruments of the highest grade and intend to meet the requirements of our patrons in every particular.

A special department for the manufacture of Physical and Scientific Apparatus and Precision Weights and Measures has been added within a few years, and we solicit the patronage of those interested who require apparatus of high grade and approved workmanship and will mail a catalogue on request.

To meet the demands of our business, we have opened a branch factory at Seattle, Washington, where a full line of our manufactures may be found and where the repair and adjustment of instruments may be made by skilled workmen, under competent direction.

W. & L. E. GURLEY,
TROY, N. Y., U. S. A.

May, 1912.



William Gurley







Lewis E. Gurley



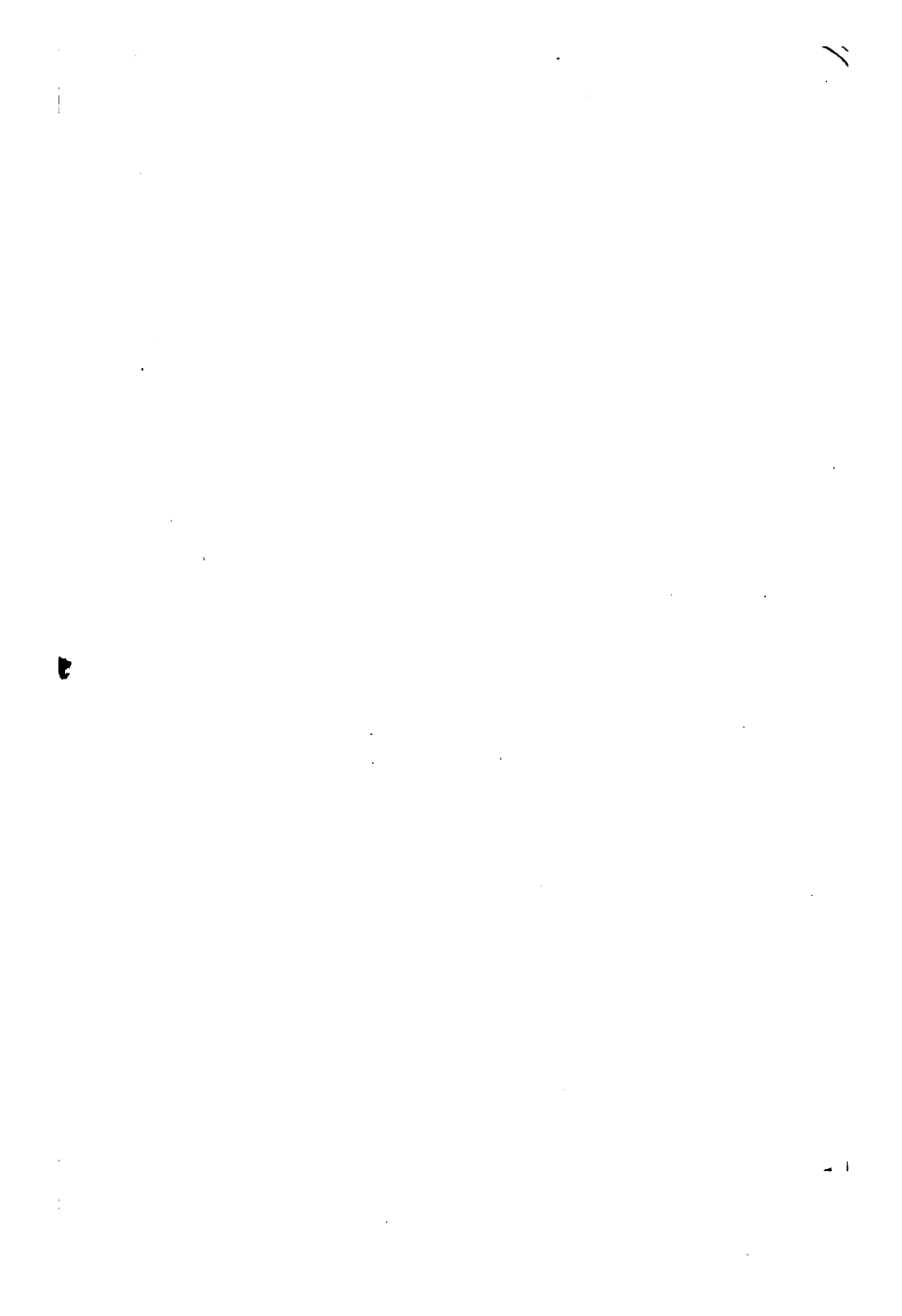



No. 28
LIGHT MOUNTAIN TRANSIT
[Page 16]

TRANSIT INSTRUMENTS

THE AMERICAN TRANSIT is by far the most important instrument used in engineering. The essential parts, which may be seen in the illustrations, are the telescope with its axis, the standards, the circular plates with their attachments, the sockets upon which the plates revolve, the leveling head, and the tripod upon which the whole instrument stands.

The telescope is secured in an axis having its bearings fitted in the standards, allowing the telescope to transit. The different parts of the telescope are shown in the illustration on page 18.

The objective is an achromatic lens placed at the end of a slide having two bearings, one at the end of the outer tube, the other in the ring, C C, which is suspended within the tube by four screws, only two of which are shown.

The eyepiece is composed of four lenses which are called respectively the eye, the field, the amplifying, and the object lenses, the whole forming a compound microscope focusing on the cross wires attached to the ring, B B.

In all our transits, with the exception of the Explorers Reconnaissance, and Builders Transits, both the objective and eyepiece are moved out or in by pinions working in racks attached to their sides, and are thus adjusted to proper focus. In the instruments named, the eyepiece is focused by a spiral movement.

Sometimes an eyepiece with only two lenses is used, but while this gives more light it presents an inverted image of the object observed, and is not often desired by American Engineers.

The objective, receiving the rays of light from all points of a visible object, converges them to a focus at the cross wires, and there forms a minute, inverted image, which may be seen by placing a piece of ground glass at that point to receive it.

The eyepiece magnifies this image, restores it to its natural position and conveys it to the eye.

The visual angle which the image subtends is as many times greater than that which would be formed without the aid of the telescope as the number which expresses its magnifying power is greater than unity. Thus, a telescope which magnifies twenty times increases the visual angle in the same proportion, and therefore diminishes the apparent distance of the object twenty times. In other words, it will show an object two hundred feet distant with the same distinctness as if it were only ten feet distant from the naked eye.

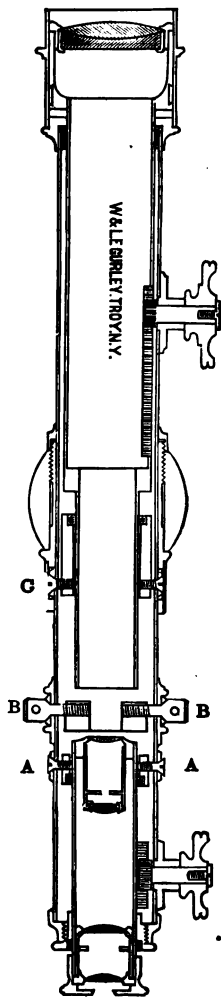

It is often supposed that the greater the power of a telescope the better; but, beyond a certain limit, this is not true. As only a given amount of light can enter the objective, the more the object is magnified the less clear and bright will it appear. A power of from twenty to twenty four diameters in the telescopes of transits gives the best results, and is sufficient for all ordinary practice.

The cross wires are two wires of very fine platinum, mounted on the face of a metal ring. They are placed at right angles with each other, so as to divide the space in the center into quadrants.

The advantage of platinum over spider web for the cross wires of telescopes has long been conceded, but the difficulty of procuring it of sufficient fineness has prevented its general use. We are successfully drawing platinum wires of from one eight thousandth to one fifty thousandth of an inch in diameter, and are using them in the telescopes of all our instruments. These wires are opaque and unaffected by moisture, and are universally preferred to the spider web formerly used.

The intersection of the wires forms a point which, when adjusted, enables the surveyor to fix the telescope upon an object with precision. The imaginary line passing through the optical axis of the telescope is called the line of collimation, and the process of bringing the intersection of the wires into the optical axis

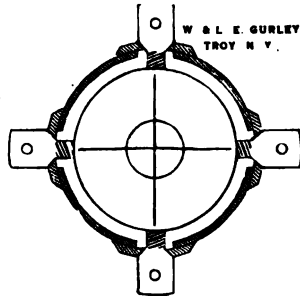

is called the adjustment of the line of collimation. This is described on pages 38-40.

The sectional view of the telescope on page 18 shows two movable rings, one at A A, the other at C C, which are used respectively in centering the eyepiece and in the adjustment of the objective slide.

The centering of the eyepiece is effected after the wires have been adjusted, by moving the ring, by means of the screws shown on the outside of the tube, until the intersection of the wires is brought into the center of the field of view.

The adjustment of the objective slide, which is described on page 41, keeps the line of collimation in adjustment through the whole range of the slide. This is peculiar to our telescopes, is always made in the process of manufacture, and needs no attention from the engineer, unless the instrument is severely injured.

The stadia is a compound cross wire ring or diaphragm, as shown on page 24, having three horizontal wires, of which the middle one is attached to the ring as usual, while the others are fastened to slides, held apart by springs and actuated by independent screws, by which the distance between the two movable wires can be adjusted to include a given space, as one foot on a rod one hundred feet distant.

These wires will in the same manner include two feet on a rod two hundred feet distant, or half a foot at a distance of fifty feet, and so on in the same proportion, thus furnishing a means of measuring distances, especially over broken ground, more easily and even more accurately than with a tape or chain. Stadia wires are inserted in all our transit telescopes without extra cost, if requested when the instrument is ordered.



No. 12
ENGINEERS TRANSIT, TWO VERNIERS TO LIMB
[Page 21]





The stadia wires are fixed, when desired, on the same ring with the cross wires, and when thus placed they are not adjustable, but are accurately and permanently set by us to read distances as above.

The stadia wires are usually arranged so that they are seen at the same time as the cross wires. When desired, we place them so that they are out of focus when the cross wires are visible, or vice versa. Many engineers prefer this method, as being less confusing to the observer and lessening the liability of error.

The increasing use of the stadia, often demanding the measurement of short distances with the utmost accuracy, compels the use of the so called stadia "constant"; that is, the wires are adjusted to read one foot on the rod at a distance from the center of the instrument of one hundred feet plus c plus f , c being the distance of the objective from the center of the instrument, found by measuring from the center of the axis to the shoulder of the setting of the objective when it is focused on a distant object, and f being the focal length of the objective, found by measuring from the cross wires to the objective.

The reason for this is that the rays cross each other so that the vertex of the visual angle is not at the center of the instrument, but at a distance in front of the objective equal to its focal length.

The constant for each instrument, or distance of the zero of the indicated distance in front of the center of the instrument, is noted on a card placed in the instrument box.

For example, in our eleven inch telescopes, such as are used with our larger transits, $c = 5.6$ inches and $f = 8.2$

inches; $c + f = 1.15$ feet. In the Mountain Transit telescopes, $c = 4$ inches and $f = 5.4$ inches; $c + f = 0.783$ feet. In the Reconnaissance Transit telescopes, $c = 4.25$ inches and $f = 5.75$ inches; $c + f = 0.833$ feet.

This constant never varies for any given instrument, and is independent of the distance itself.

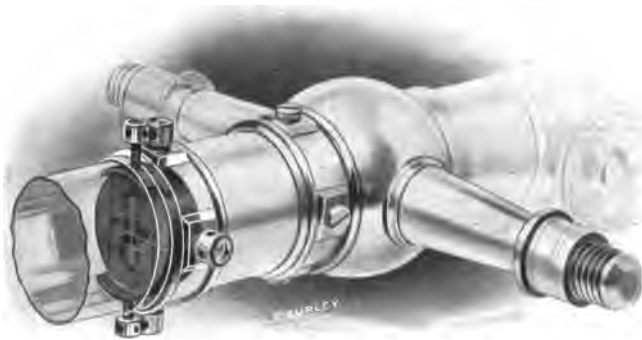

The dust guard No. 154 to the objective slide, is placed on the telescopes of Transits Nos. 1 to 90, and Nos. 110 to 117.

Dust Guard This guard protects the objective slide, and prevents any dust or foreign substance from interfering with its perfect action.

With the telescope of the ordinary transit it is impossible to focus on objects at a distance of less than ten feet. In **Short Focus** order to enable the observer to see objects near the instrument, we have recently introduced an important modification of the telescopes used on our transits, so

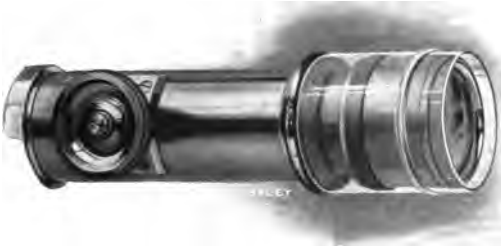

No. 154

that they can be focused on an object at a distance of about four and one half feet from the center of the instrument.

To facilitate the setting of the transit precisely under a **Center Point** given point, we make in the top of the ball of the telescope axis, and directly over the center of the instrument, a small conical hole or center point.

The standards of the transit are firmly attached by their expanded bases to the upper plate, one of them having near the top a little box, as shown on **Standards** page 89, movable by a screw underneath, by which the telescope axis is made horizontal, as described on page 40.

The magnetic needle varies in length in the different sizes of transits. The brass cap has inserted in it a perfectly **Magnetic Needle** polished jeweled center of special shape, and this, resting upon the hardened and polished point of the center pin, allows the needle to play freely and settle in the magnetic meridian.

The needle has on its south end a coil of wire, easily moved, to bring both ends of the needle to the same level. A screw passing through the upper plate moves a concealed lever by which the button is raised, thus lifting the needle from the pin so as to check its vibration, or to bring it up against the glass when not in use, avoiding unnecessary wear of the pivot.

The form of the needle is varied as desired by the surveyor, but is of two general classes, one having the greatest breadth in a horizontal, the other in a vertical, direction. We usually make our needles about eight one hundredths of an inch broad, and about three one hundredths of an inch thick, with the ends brought to a sharp vertical edge.

The test of the delicacy of a magnetic needle is the number of horizontal vibrations which it will make in a certain arc before coming to rest. Most surveyors desire also a quivering motion in the needle. This quality, which is manifested more in a horizontal than in a vertical needle, depends upon the near coincidence of the point of suspension with the center of gravity of the needle, and merely serves to show that the cap is unobstructed.

The compass box containing the needle is covered by a glass to exclude moisture and air. The covers on all our instruments are made of special selected plate glass, beveled on the edge and set flush with the bezel ring, thus facilitating the removal of moisture and affording an unobstructed observation of the compass face. The compass circle is silvered and graduated on its upper surface in degrees and half degrees, and figured from 0 to 90 each way. The degree marks are also cut down on the inner edge of the circle.

Variation] An arc for setting off the magnetic declina-
Arc tion is furnished with any new Engineers Transit, Nos. 1 to 16, if ordered with the instrument, at an extra cost of four dollars (\$4.00). Whenever possible the plates of our transits are so ribbed on the under side as to give them the greatest rigidity.

The clamp and tangent movement has its tangent screw with opposing spring attached to the upper plate, as shown in illustration of No. 12. The clamp is shown in the sectional cut on page 18, being a strong metal ring, D F, moving easily around the outer socket, to which it may be clamped by the screw, E, impinging upon a segment, F. The plates are thus held and moved slowly around each other in either direction by the tangent screw, or loosened and moved by the hand, the telescope being thus easily and accurately directed to the point of sight.

The two levels are placed at right angles with each other so as to level the plate in all directions, and are adjusted by turning the capstan head nuts at their ends by a steel adjusting pin. The glass vials used in the levels of all our transits are ground on their inner surface, to give the bubble an even motion and sensitiveness.

The limbs of all our transits, Nos. 1 to 102, are graduated on sterling silver, usually to half degrees, and read by vernier to one minute. If desired, the limb and verniers may be graduated to read to thirty, twenty, or ten seconds, but at an additional cost. Limbs of transits are ribbed securing great strength without increase of weight.

Various methods of figuring are used, and we show illustrations of those which we most commonly furnish.

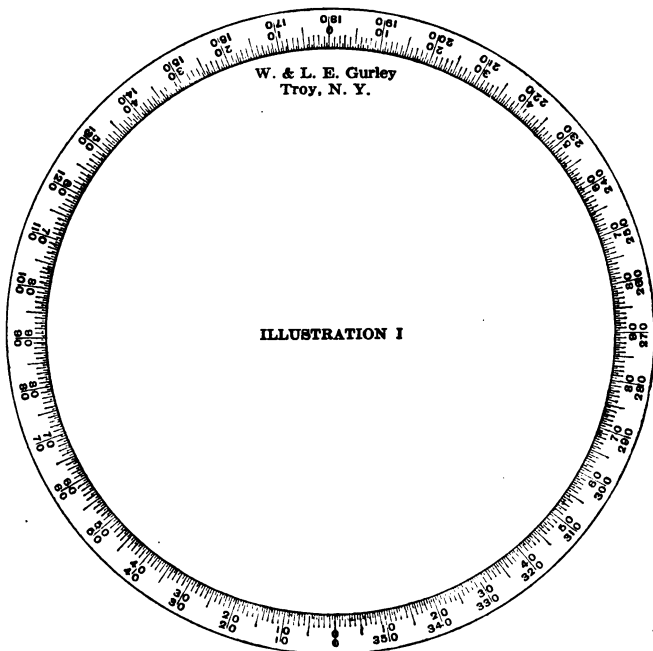

ILLUSTRATION I — The figures are in two rows, the outer from 0 to 360, and the inner in quadrants from 0 to 90. This is the customary form.

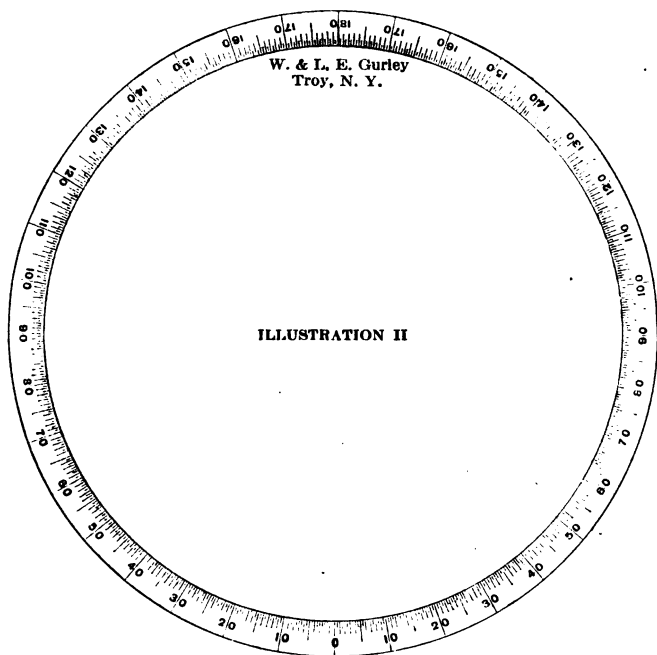

ILLUSTRATION II—The figures are in one row, reading from 0 each way to 180. This is the usual figuring on the limbs of Transits Nos. 20, 100, 102, and 105.

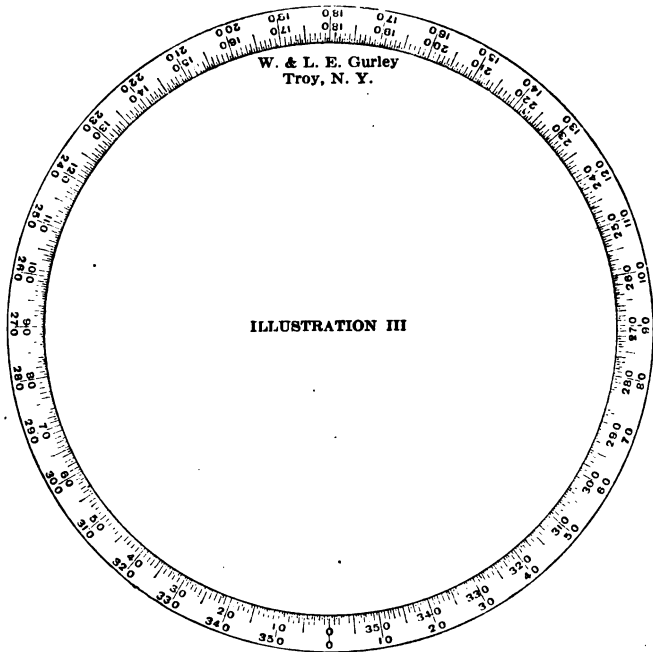
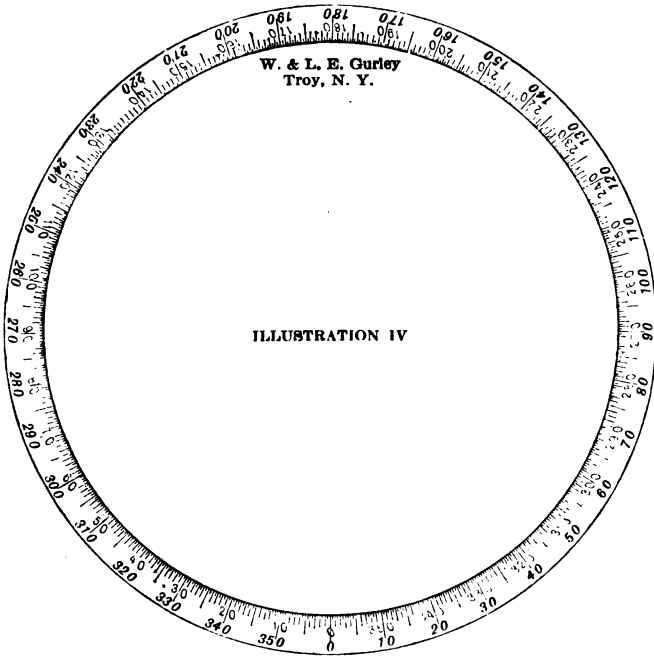

ILLUSTRATION III — The figures are in two rows, each row from 0 to 360, but reading in opposite directions.

ILLUSTRATION IV — The numbering is identical with that used in III, except that the figures are inclined in the direction in which they increase.



We will furnish new transits with the limbs figured as specified by the purchaser, without extra charge, and limbs regraduated will be figured as ordered. Limbs cannot be refigured without regraduation and readjustment, the cost of readjustment being additional to the regular charge for regraduation.

The verniers, V V, are attached to the upper plate diametrically opposite each other, and are used in reading the limb within which they revolve. They are placed at an angle of thirty degrees with the line of sight so that they may be easily read without a change of position by the observer. The vernier openings are covered with glass, carefully cemented to exclude moisture and dust.

The verniers are double, having on each side of the zero mark thirty equal spaces corresponding precisely with twenty nine half degrees of the limb. They thus read to single minutes, and the number passed over is counted in the direction in which the vernier is moved. Sometimes a finer reading than minutes is desired, and the spaces of the limb and vernier are then made proportionately less. (See page 27.)

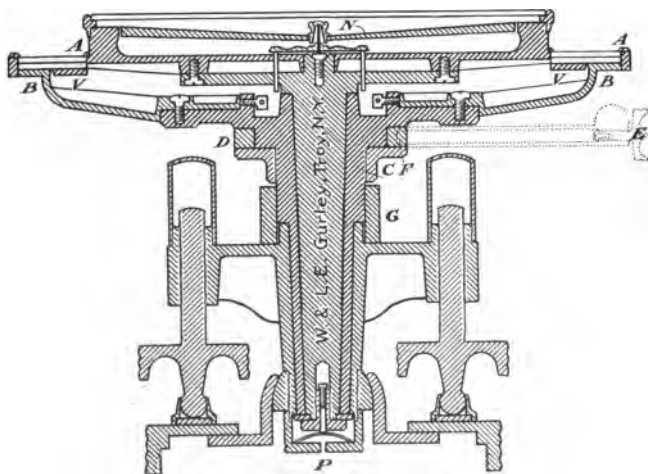

SOCKETS AND CIRCULAR PLATES

The use of two opposite verniers gives the means of cross questioning the graduations, the perfection with which they are centered, and the accuracy of the angles indicated.

Reflectors of celluloid, as in the Mountain Transit, are often used to throw white light upon the graduations, and shades of ground glass are sometimes used to give a more subdued light.

The graduations were formerly made on the brass surface of the limb, afterward filled with black wax and then finished and silvered. The limbs of all our transits are now graduated on sterling silver. The graduations are much finer and more distinct, and the surface is less liable to become tarnished.

To secure the utmost accuracy of graduation and avoid any possibility of molecular change after the graduation is made, the limbs of our transits are polished and the figures engraved before cutting the divisions.

The sockets of the transit are compound. The interior spindle attached to the vernier plate turns in the exterior socket, C, when an angle is taken on the limb; but when the plates are clamped the exterior socket itself, and with it the whole instrument, revolves in the socket of the leveling head.

The sockets are constructed with the greatest care. They are truly concentric, and the composition of which they are made is of different degrees of hardness, causing them to move upon each other with the least possible wear.

The leveling head consists of two plates connected by a socket, which has at its end a hemispherical nut fitting into a corresponding cavity in the lower plate. The plates are inclined to each other or made

parallel by four leveling screws. If specially ordered, we make the leveling head with three leveling screws.

The screws are of bronze with threads accurately fitted in long turnings in the arms of the ribbed socket of the leveling head and are protected from dust by brass covers. The screws rest in cups or sockets, in which they turn without marring the surface of the lower plate, the cups allowing the screws to be shifted from side to side, or turned in either direction on the lower plate.

The clamp and tangent movement of the leveling head, partially shown in illustration of No. 12, serves to turn the whole instrument upon its sockets, so as to fix the telescope with precision upon any given point, or when unclamped allows it to be directed approximately by hand. The tangent screw is single, and has an opposing spring by which lost motion is avoided and a very delicate and prompt movement secured.

The lower leveling plate is in two pieces, the upper one, which is screwed to the top of the tripod, having a large opening in the center, in which the smaller lower plate is shifted from side to side. By this device, called a shifting center, the instrument may be easily moved over the upper plate, and the plummet which hangs from the center, P (see page 32), may be set precisely over a point without moving the tripod.

The tripod has a head of bronze with three strong tenons to receive the legs, the upper ends of which are pressed firmly on each side of the tenon by a bolt and nut on opposite sides of the leg. This nut can be screwed up, and thus kept firm. The lower end of the leg has a brass shoe with steel point, securely fastened and riveted to the wood.

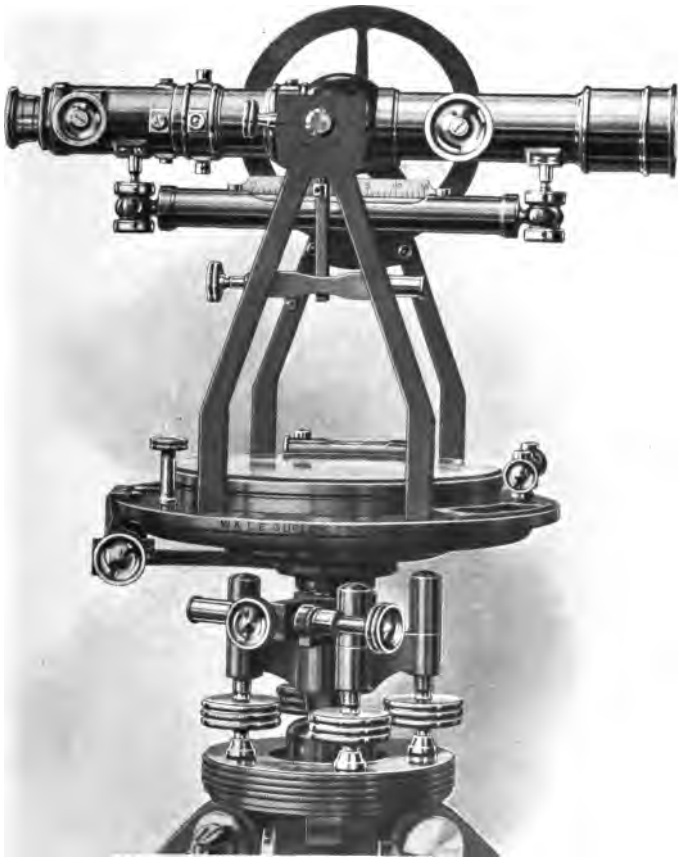

No. 14
ENGINEERS TRANSIT, TWO VERNIERS TO LIMB

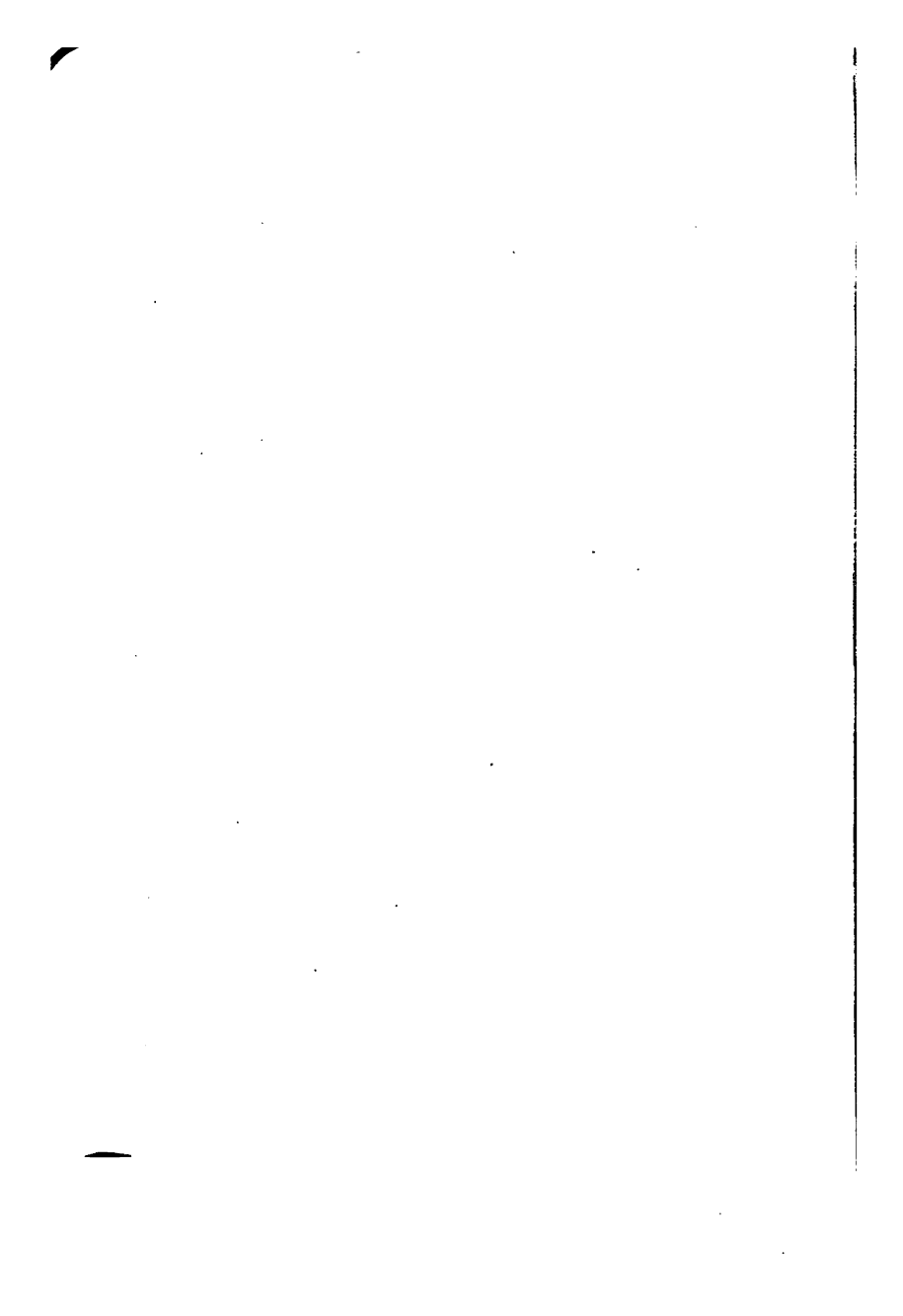

TO USE THE TRANSIT

The instrument should be set up firmly, the tripod legs being pressed into the ground, so as to bring the plates as nearly level as convenient. The plates should then be carefully leveled and properly clamped.

For precise work, in addition to leveling by the plate levels, it is always advisable, if the transit has such attachment, to level the plates by the telescope level, as this is much more sensitive than the levels on the plate. In this operation the position of the level on telescope must be observed over each pair of leveling screws in turn, and one half the correction made by the axis tangent, the other half by the leveling screws.

Before an observation is made with the telescope, the eyepiece should be focused until the cross wires appear distinct. The objective is then focused until the object is seen clear and well defined, and the wires appear as if fastened to its surface. The intersection of the wires should be brought precisely upon the object to which the telescope is directed.

The zeros of the verniers and limb should be brought into line by the tangent screw of the plates, and the telescope directed to the object, by the tangent screw of the leveling head. The angles taken are then read off upon the limb, without subtracting from those given by the verniers in any other position.

TO ADJUST THE TRANSIT

Each instrument leaves the hands of the maker in complete adjustment, but all adjustments are so liable to derangement by accident or careless use that it is necessary to describe particularly those which are most likely to need attention.

The principal adjustments of the transit are: the Levels, the Line of Collimation, the Standards.

To adjust the levels: Set the instrument upon its tripod as nearly level as may be, and having unclamped the plates,

Levels bring the two levels above, and on a line with, the two pairs of leveling screws. Clasp the heads of two opposite screws, and, turning both in or out, as may be needed, bring the bubble of the level directly over the screws exactly to the middle of the opening. Without moving the instrument, proceed in the same manner to bring the other bubble to the middle. The level first corrected may now be thrown a little out; if so, bring it in again, and when both are in place turn the instrument half way around. If the bubbles are both in the middle they need no correction; but if not, turn the nuts at the end of the levels with the adjusting pin, until the bubbles are moved over half the error. Bring the bubbles again into the middle by the leveling screws, and repeat the operation until the bubbles will remain in the middle during a complete revolution of the instrument.

To adjust the line of collimation: This adjustment is to bring the cross wires into such a position that the instrument,

Line of Collimation when placed at the middle of a straight line, will, by the transit of the telescope, cut the extremities of the line. Having leveled the instrument, determine if the vertical wire is plumb, by focusing on a defined point and observing if the wire remains on that point when the telescope is elevated or depressed. If not, loosen the cross wire screws and by their heads turn the ring until correct, the openings in the telescope tube being slightly larger than the screws, so that when the latter are loosened the ring can be rotated a short distance in either direction

Direct the intersection of the cross wires on an object two or three hundred feet distant. Set the clamps and transit to an object about the same distance in the opposite direction. Unclamp, turn the plates half way around, and direct again to the first object; then transit to the second object. If it strikes the same place the adjustment is correct. If not, the space which intervenes between the points bisected in the two observations will be double the deviation from a true straight line, since the error is the result of two observations.

In the diagram below, let A represent the center of the instrument, and B C the imaginary straight line, upon the extremities of which the line of collimation is to be adjusted. B represents the object first selected, and D the point which the wires bisected when the telescope was reversed.



When the instrument is turned half around, and the telescope again directed to B, and once more reversed, the wires will bisect an object, E, situated as far to one side of the true line as the point, D, is on the other side. The space, D E, is therefore the sum of two deviations of the wires from a true straight line, and the error is made apparent.

In order to correct it, use the two capstan head screws on the sides of the telescope, these being the ones which affect the position of the vertical wire. It must be kept in mind that the eyepiece apparently inverts the position of the wires, and therefore, in loosening one of the screws and tightening the other on the opposite side, the operator must proceed as if to increase the error observed.

The wires being adjusted, their intersection may now be

brought into the center of the field of view by moving the screws, A A, shown in the sectional view of the telescope on page 18, which are slackened and tightened in pairs, the movement being now direct, until the wires are seen in their proper position.

The position of the line of collimation depends upon that of the objective solely, so that the eyepiece may, as in the case just described, be moved in any direction, or even removed and a new one substituted, without at all deranging the adjustment of the wires.

In case it becomes necessary to remove the cross wire ring, the operator should proceed as follows: Take out the eyepiece, together with the ring by which it is centered, remove two opposite cross wire screws, and with the others turn the ring until one of the screw holes is brought into view from the open end of the telescope tube. In this screw hole thrust a splinter of wood or a wire, to hold the ring when the remaining screws are withdrawn. The ring can then be removed. It may be replaced by returning it to its position in the tube, and after either pair of screws is inserted the splinter or wire is removed, and the ring is turned until the other screws can be replaced, care being taken that the face of the diaphragm is turned toward the eyepiece. The eyepiece is next inserted, and its centering ring brought into such a position that the screws in it can be replaced, and the ring into which the eyepiece is fixed is then screwed to the end of the telescope.

To adjust the standards: In order that the point of intersection of the wires may trace a vertical line as the telescope
Standards is elevated or depressed, it is necessary that the standards of the telescope should be of precisely the same height. To ascertain this, and make the correction, if needed, proceed as follows:

Having the line of collimation properly adjusted, set up the instrument in a position where points of observation, such as the apex and base of a lofty spire, can be selected, giving a long range in a vertical direction.

Level the instrument, direct the telescope to the top of the object, and clamp to the spindle; then bring the telescope down until the wires bisect some well defined point at the base. Turn the instrument half around, direct the telescope to the lower point, clamp to the spindle, and raise the telescope to the highest point. If the wires bisect it, the vertical adjustment is effected; if they are thrown to either side, this proves that the standard opposite to that side is the highest, the apparent error being double that actually due to this cause. To correct it, we make one of the bearings of the axis movable, so that by turning a screw underneath this sliding piece, as well as the screws which fasten the cap of the standard, the adjustment is made with precision.

Besides the three adjustments described, which are all that the surveyor will ordinarily be required to make, there are other adjustments of the transit which may sometimes be necessary.

In case of accident or injury it may be necessary to adjust the objective slide, and this should be done as follows: Having set up and leveled the instrument, the line of collimation being adjusted for objects from three hundred to five hundred feet distant, clamp the plates, and fix the vertical cross wire upon an object as distant as may be distinctly seen. Without disturbing the instrument, move out the objective so as to bring the vertical wire upon an object as near as the range of the telescope will allow. Having this clearly in mind, loosen the upper clamp, turn the instrument half way around, reverse the telescope, clamp the

instrument, and with the tangent screw bring the vertical wire again upon the near object; then draw in the objective until the distant object first sighted upon is brought into distinct vision. If the vertical wire strikes the same line as at first, the slide is correct for both near and remote objects, and, being itself straight, for all distances.

But if there is an error, proceed as follows: With a screw driver turn the two screws, C C (see page 18), on the opposite sides of the telescope, loosening one and tightening the other, so as to apparently increase the error, making, by estimation, one half the correction required. Then go over the usual adjustment of the line of collimation, and, having completed it, repeat the operation above described, first sighting upon the distant object, then upon a near one in line, then reversing, making corrections, etc., until the adjustment is complete.

This adjustment is peculiar to our transits, and furnishes the only way in which the line of collimation can be made correct for all distances.

The adjustments of the vertical circle and the level on telescope are described on pages 80 to 84.



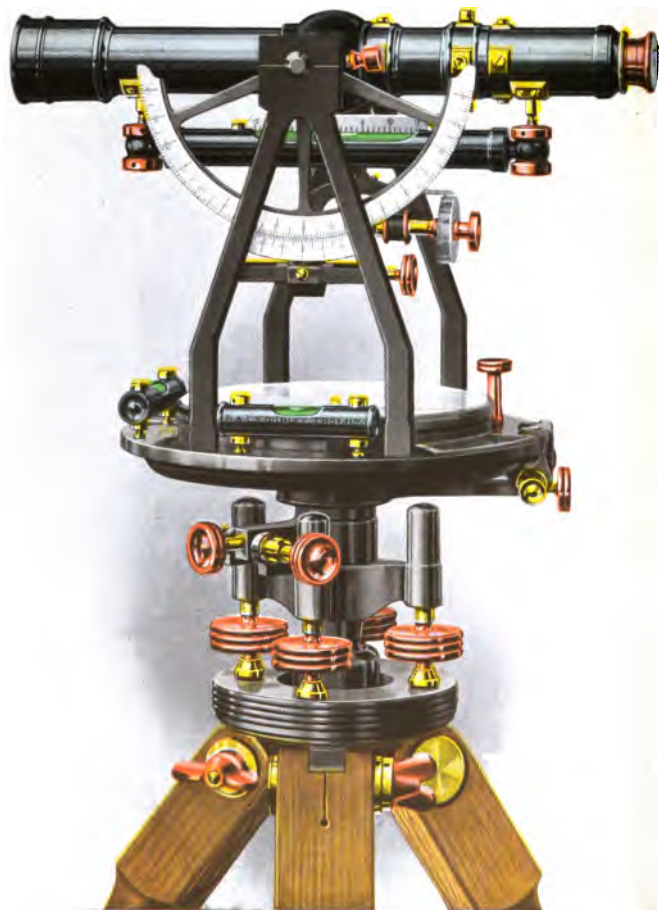

No. 16
ENGINEERS TRANSIT, TWO VERNIERS TO LIMB
[Page 44]

ENGINEERS TRANSIT

THE circular plates of the Engineers Transit, with their sockets, are shown in section on page 32. The upper plate, A A, carrying the compass circle, is screwed to the flange of the interior spindle; the lower plate or divided limb, B, is fastened to the exterior socket, C, which again is fitted to and turns in the hollow socket of the leveling head.

The long sockets of the transit are supported in the leveling head, which is secured to the sockets by a screw and washer underneath.

The illustration of No. 16 shows some of the attachments often used with the transit; the vertical arc, level on Attachments telescope, and clamp and tangent to tele-
to Transits scope axis with gradienter screw. These and other attachments are used where leveling, taking vertical angles, etc., must be done in connection with the ordinary work of the transit, and the attachments and their adjustments are described on pages 80 to 127.

We make three sizes of the Engineers Transit, having Sizes and needles respectively four, four and one half,
Weights and five inches long. The average weight of each size, with plain telescope, is as follows:

4 inch needle, about	12½ lbs.
4½ inch needle, about	14 lbs.
5 inch needle, about	16 lbs.

The tripod furnished with this transit weighs between nine and ten pounds.

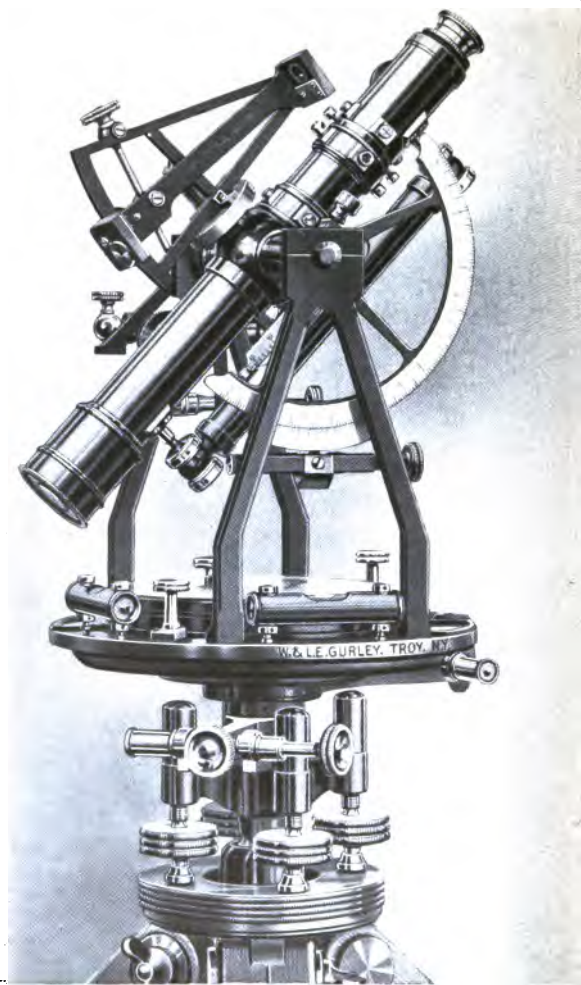

No. 17
ENGINEERS TRANSIT, WITH SOLAR ATTACHMENT, TWO VERNIERS TO LIMB
[Page 46]

The diameter of the limb of each size is as follows:

4 inch needle	5.65 inches
4½ inch needle	6.25 inches
5 inch needle	6.70 inches

When it is necessary to separate the plates of the Engineers Transit, proceed as follows: Unscrew the nut which confines the spring in the thimble opposed to the tangent screw on the upper plate; take out the three screws which fasten the tangent fixture to the upper plate; and remove the screw and washer underneath, which secure the sockets to the leveling head. The plates can then be readily separated. To put the transit together again, the operation should be exactly reversed.

ENGINEERS TRANSIT WITH SOLAR ATTACHMENT

The illustration of No. 17 represents our Engineers Transit with five inch needle, vertical arc of three inches radius, graduated on silver and reading to thirty seconds, level on telescope, clamp and tangent to telescope axis, and solar attachment with declination arc reading to thirty seconds. Platinum stadia wires are always furnished with this instrument, unless otherwise ordered.

The horizontal limb is graduated on sterling silver and reads to single minutes. When the solar attachment is ordered with a new Engineers Transit, the compass circle is made movable with rack and pinion, for setting off the magnetic declination.

EXPLORERS TRANSIT

THIS instrument is designed to meet the demand for a transit of greatest accuracy with the least possible weight. Similar to our Light Mountain Transit in pattern, the instrument itself weighs only about five pounds, and when placed in its leather covered case can be readily packed and carried in a twenty four inch dress suit case.

The telescope is six and one half inches long, with a power of about fourteen diameters, and can be focused on an object three feet from the center of the instrument. The attachments of vertical circle four inches in diameter, graduated on silver and reading to one minute, figured from 0 to 90 each way; level on telescope, and clamp and tangent to telescope axis, are furnished with the transit.

The needle is two and three quarters inches long, and the compass plate is arranged with a variation arc for setting off the magnetic declination.

The horizontal limb is four inches in diameter, graduated on silver, and reads by two opposite double verniers to one minute. Unless otherwise ordered, the limb is figured in one row from 0 to 180. The leveling head is of ribbed pattern, with shifting center, and has dust caps to the leveling screws.

The instrument is packed in a leather covered wood box, which has lock and key, shoulder strap, plummet, reading glass, and the usual small accessories.

A special extension tripod, with jointed legs and canvas carrying case, is usually furnished; but an extension tripod, similar to that used with the Light Mountain Transit, can be

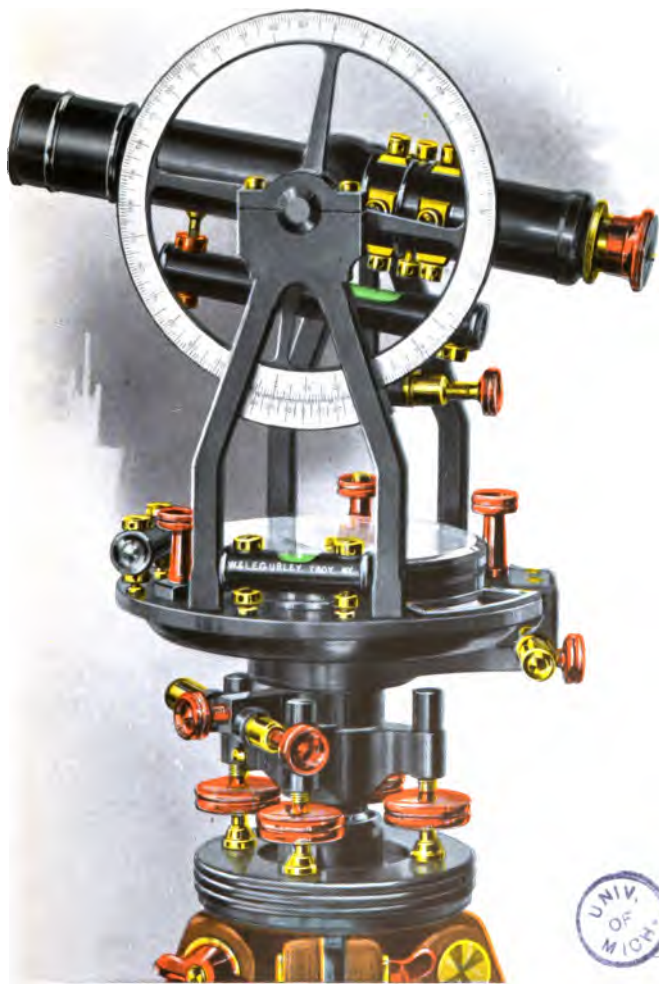

No. 20
EXPLORERS TRANSIT, TWO VERNIERS TO LIMB
[Page 49]



substituted, if desired, at a reduction of five dollars from the price of the instrument as described.

The weight of the tripod is about five pounds and the instrument box weighs about four pounds, making the weight of the complete outfit thirteen pounds.



THE EXPLORERS TRANSIT

In its box and the tripod with the jointed legs in its case can be packed and carried in an ordinary twenty-four inch dress suit case, as shown.

If desired, we can furnish a good leather dress suit case for \$8.00 extra.

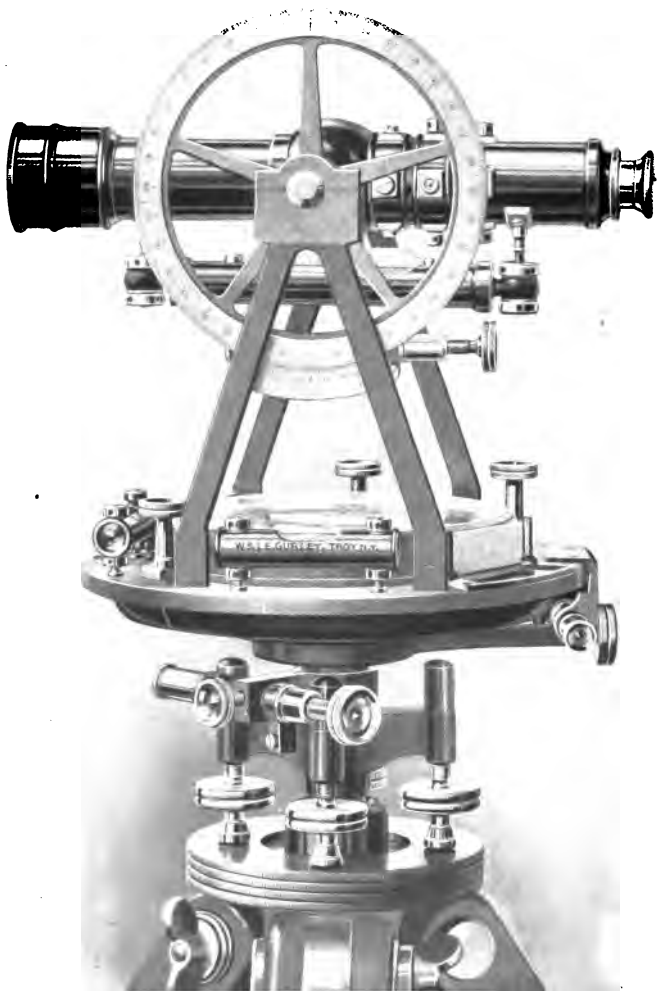

No. 27
LIGHT MOUNTAIN TRANSIT, TWO VERNIERS TO LIMB
[Page 52]

LIGHT MOUNTAIN TRANSIT

THE Light Mountain Transit, introduced by us in 1876 to meet a demand for a light instrument of the finest quality, has met with a very large sale and has been universally approved. It is especially fitted for mine or mountain surveying, where great portability is essential, but is equally adapted to the general work of the engineer. The instrument, shown on previous page, has a needle four inches long, and a telescope eight inches long with a power of twenty diameters. Platinum stadia wires are always furnished with this instrument, unless otherwise ordered.

The sockets are like those shown on page 32. The compass circle is movable about its center, so as to set off the magnetic declination.

The limb has a diameter of five and sixty five hundredths inches, and is graduated on silver, reading usually to single minutes; but, if desired, it can be graduated to read to twenty or thirty seconds at additional expense. There are caps above the leveling screws to exclude dust.

The illustration shows the celluloid reflectors, placed over the two opposite verniers of the limb to throw light upon the graduations below, which are of special convenience in the surveys of mines.

The Mountain Transit is sometimes used with a plain telescope, but oftener with one or more attachments, as vertical
Attachments for Transits circle, level and clamp and tangent, as shown. Frequently this instrument is furnished as shown in illustration of No. 30, with vertical arc, level, clamp and tangent, and solar attachment.

The Light Mountain Transit is almost always used upon our improved extension tripod (see page 228), the legs of which can be lengthened or shortened at will. It is thus adapted for use in mountain surveys, where one or more legs must be shortened, or for use in mines, where a short tripod is often indispensable.

The sliding pieces can be turned end for end, the points being thus out of the way and the tripod more easily transported. The tripod when closed is only three feet long, and is carried by a shawl strap, which we furnish with it.

Leather Case Besides the light mahogany box, in which the instrument is packed, there is also supplied a sole leather case, furnished with shoulder straps.

Weight The weight of this instrument with plain telescope and without tripod is ten pounds; with solar attachment, vertical arc, level and clamp, as shown in the illustration of No. 30, twelve pounds. The extension tripod weighs about eight and one half pounds.



No. 30
LIGHT MOUNTAIN TRANSIT, TWO VERNIERS TO LIMB
[Page 55]



SURVEYORS TRANSIT

WITH TWO VERNIERS TO THE HORIZONTAL
LIMB

THE Surveyors Transit with two verniers to limb has essentially the same construction as the Engineers Transit, but its compass circle is movable about its center, like that of the Mountain Transit, in order that the magnetic declination may be set off in the surveys of old lines, or in running lines by the true meridian.

The arrangement of the sockets and leveling head permits the Surveyors Transit to be detached from the leveling head and replaced upon its spindle, when desired, without disturbing its adjustments.

The sectional view (page 58) shows the interior construction of the sockets of the transit, the manner in which it is detached from its spindle, and the means by which it can be taken apart.

In the figure the limb, B, is attached to the main socket, C, which is itself fitted to the conical spindle, H, and held in place by the spring catch, S.

The upper plate, A, carrying the compass circle, standards, etc., is fastened to the flange of the socket, K, which is fitted to the upper conical surface of the main socket, C, the weight of all the parts being supported on the small bearings of the end of the socket, as shown, so as to turn with the least possible friction.

A small conical center, in which a screw is inserted from below, is brought down firmly upon the upper end of the main socket, C, thus holding the two plates of the instrument

securely together, and at the same time allowing them to move freely around each other in use. A disk above the conical center contains the steel center pin upon which rests the needle, as shown, the disk being fastened to the upper plate by two screws.

The clamp to limb, with clamp screw, is also shown at D F, attached to the main socket below.

The main socket, with all its parts, is of the best bell metal, and is most carefully and thoroughly made, the long bearing of the sockets insuring their firm and easy movement, while at the same time they are entirely out of reach of dust or other source of wear.

When desired, the whole upper part of the instrument may be taken off from the spindle by pulling out the head of the

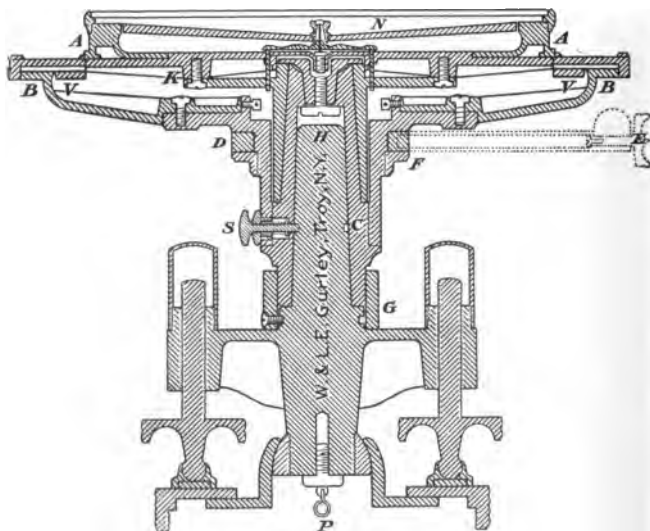

SOCKETS AND CIRCULAR PLATES



No. 47
SURVEYORS TRANSIT, TWO VERNIERS TO LIMB
[Page 59]





spring catch at S, and when replaced is secured by the spring of the catch.

The figure also shows the covers of the leveling screws, the shifting center of the lower leveling plate, and the screw and loop for the attachment of the plummet.

Sizes and Weights The sizes and weights of the Surveyors Transit with two verniers to limb, and having plain telescope, are:

4 in. needle, with leveling head, but no tripod, about	13 $\frac{3}{4}$ lbs.
5 in. needle, " " " " " " " "	16 $\frac{1}{2}$ lbs.
5 $\frac{1}{2}$ in. needle, " " " " " " " "	17 $\frac{1}{2}$ lbs.

The diameter of the limb of each size is as follows:

4 inch needle	5.65 inches
5 inch needle	6.70 inches
5 $\frac{1}{2}$ inch needle	7.20 inches

When it is necessary to separate the plates of this transit, proceed as follows (see page 58): Unscrew the milled head cap from the thimble containing the opposing spring of the tangent movement to limb, and take out the three screws which fasten that movement to the upper plate. Remove the clamp screw of the variation arc and take off the head of the pinion, both outside the compass circle. Unscrew the bezel ring holding the glass cover of the compass, remove the needle and button beneath it, and take out the two screws, to remove the disk. Take the instrument from its spindle, and with a screw driver take out the screw from the under side of the conical center, and drive out the center from below by a round piece of wood, holding the instrument so that the center will not bruise the circle. The plates can then be separated. To put the transit together again, the operation should be exactly reversed.

SURVEYORS TRANSIT

WITH ONE VERNIER TO THE HORIZONTAL LIMB

THE Surveyors Transit with one vernier to limb is a modification of the instrument just described, in which there is but one double vernier to limb and a different arrangement of the sockets, as shown in the sectional cut on page 65.

The instrument is more compact and somewhat lighter than that with two verniers, and is furnished at a lower price. Its graduations, telescope, and attachments are equal to those of the more expensive transits; and after an experience of more than forty years the instrument has proved itself satisfactory for all classes of work.

The adjustments and use of this instrument are like those of the others already described, and its attachments to the telescope the same.

It is represented in the illustration with a level on telescope and clamp and tangent to telescope axis. (See No. 76.)

The sectional cut, page 65, shows the arrangement of the sockets of this instrument. The spindle, C, is fitted to the socket of the leveling head, and connected therewith by a screw and washer underneath.

The socket, K, is formed in the metal of the upper plate, a strong washer with four screws, only two of which are seen in the cut, keeping the two plates together, at the same time allowing them to turn freely around each other.

The clamp to limb, with clamp screw, is shown in dotted lines at D F, under the plates.

The vernier with the opening above is shown on the left at A. The arrangement of the center pin, needle, etc., is



No. 76
SURVEYORS TRANSIT, ONE VERNIER TO LIMB
[Page 63]



like that of the transit with two verniers, but the instrument remains attached to the leveling head like the Engineers Transit.

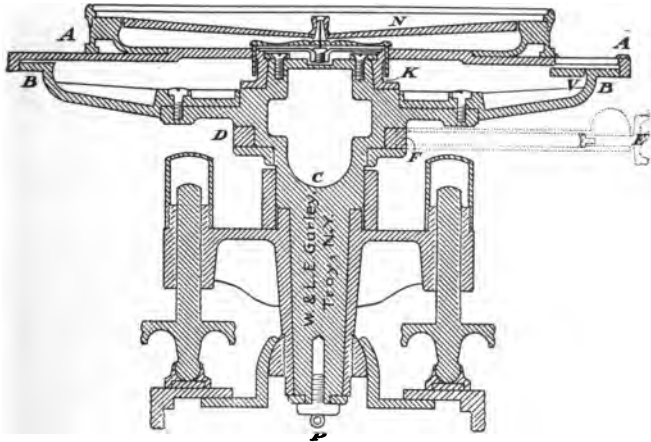

SOCKETS AND CIRCULAR PLATES

Sizes and Weights

The sizes and weights of the Surveyors Transit with one vernier to limb, and having plain telescope, are:

- 4 in. needle, with leveling head, but no tripod, about 13 lbs.
- 5 in. needle, " " " " " " " " 16 lbs.
- 5½ in. needle, " " " " " " " " 17 lbs.

The diameter of the limb of each size is as follows :

- 4 inch needle 5.65 inches
- 5 inch needle 6.70 inches
- 5½ inch needle 7.20 inches

To take apart the Surveyors Transit with one vernier to limb: Unscrew the milled head cap of the tangent opposing spring, and take out the three screws which secure the tangent support to the upper plate. Remove the pinion head and

clamp screw near the compass circle; unscrew the bezel ring, take out the needle and button underneath, and remove the disk in which the center pin is fixed, by taking out two screws which hold it. Remove the four screws which hold the washer to the under plate, and the plates can be easily separated. The several parts must be replaced in the reverse order.

SURVEYORS TRANSIT WITH SOLAR ATTACHMENT

The illustration on page 67 represents our Surveyors Transit with five inch needle and with two verniers to the horizontal limb, to which is added the solar attachment, with vertical arc, level on telescope, and clamp and tangent to axis of telescope. Both the vertical arc and the arc of the declination arm are graduated on silver, and read by vernier to thirty seconds.

The solar attachment may be used upon the transit with two verniers to limb or with one vernier to limb, as preferred. Both instruments are provided with shifting center to the leveling head. Platinum stadia wires are furnished with every solar instrument, unless otherwise ordered.



No. 60

SURVEYORS TRANSIT WITH SOLAR ATTACHMENT, TWO VERNIERS TO LIMB

[Page 67]

RECONNOISSANCE TRANSIT

IN response to a demand for a very light transit for rapid work, where extreme accuracy is not required, we introduced in 1887 the Reconnaissance Transit, No. 100. This instrument is finished with the same care as our larger and more expensive transits, and we recommend it as reliable for a great variety of work. Its quality, together with its portability, have made it very popular.

It has a needle three and one half inches in length, a limb four and ninety six hundredths inches in diameter, graduated on silver and reading by one double vernier to single minutes, and a spring tangent movement like the larger transits. The limb is figured from 0 to 180, unless otherwise ordered.

The telescope is nine inches long and has a power of from eighteen to twenty diameters. It has a long level, vertical circle reading to five minutes, and clamp and tangent to axis of telescope. The objective is focused by a rack and pinion and the eyepiece by a spiral movement. Platinum stadia wires are always furnished with this instrument, unless otherwise ordered.

A vertical circle four and one half inches in diameter and reading to one minute is often supplied with this instrument at a small additional cost.

The compass circle is arranged to set off the magnetic declination, the movement being made by a pinion.

The instrument has, as shown, a leveling head with shifting center, and with spring clamp and tangent, and it is used upon a light extension tripod, the legs of which close up to about three feet. The weight of this transit without the tripod is about seven and three quarters pounds; complete with tripod, about fifteen pounds.

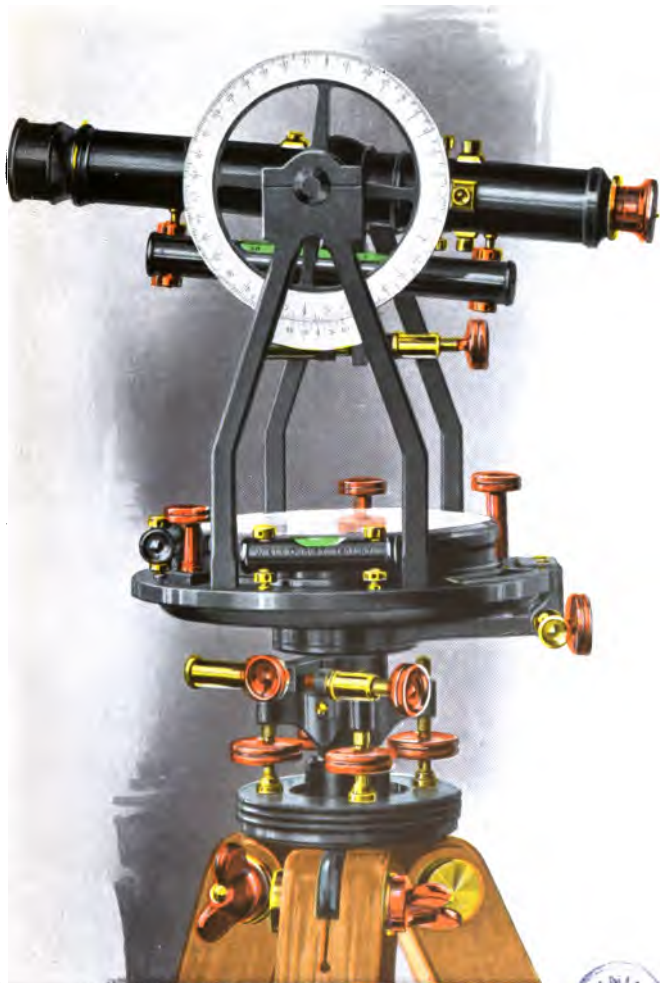

No. 100
RECONNOISSANCE TRANSIT, ONE VERNIER TO LIMB
[Page 69]





BRANCH FACTORY

WE have recently established a branch factory at Seattle, Washington.

A large stock of finished instruments and supplies is kept on hand and customers in the North West will be able to have orders filled without the delay and expense of shipment from Troy.

Special attention is given to the repairing and adjustment of Engineers and Surveyors instruments. With a complete equipment and competent workmen under the immediate supervision of a manager who has had over twenty years of experience, we guarantee our work to be of the highest quality.

W. & L. E. GURLEY

MARITIME BLDG., COR. WESTERN AVENUE & MADISON STREET
SEATTLE, WASHINGTON

W. J. RANKEN, JR., *Manager*

BUILDERS TRANSIT

THE Builders Transit, shown on the following page, is an instrument devised for use in the construction of buildings where it is necessary not only to furnish levels, but to determine points in a vertical plane above or below the level line, or on either side and in line with the center of the instrument, more conveniently than can be done with the Architects Level. This transit has a telescope with long graduated level, clamp and tangent to axis, a graduated limb reading by an index to one degree and figured from 0 to 180 each way, clamp and tangent to both limb and leveling head, shifting center, plain tripod, and trivet plate.

In use, the instrument is set either upon the tripod or trivet, and the plates are accurately leveled by the two levels shown.

If it is desired to run a level line, the bubble of the telescope level is brought into the middle by the clamp and tangent of the axis, in which position the horizontal wire of the telescope will determine a level line, as in the telescope of the ordinary level, and any horizontal angle to one degree may be read off upon the limb.

When necessary to obtain points in a vertical plane, either above or below a given point, the plates should be clamped and the clamp of the telescope axis released, when the telescope may be directed either above or below to the point desired.

To determine two points in a straight line with the instrument and on opposite sides of its center, direct the telescope to one of the points, clamp the plates, and obtain the other point by reversing the telescope upon its axis.



No. 105
BUILDERS TRANSIT
[Page 73]





.

.

—

VERNIER TRANSIT COMPASS

THIS instrument, shown in illustration of No. 118, is essentially a vernier compass with a telescope instead of the sight vanes, thus giving the surveyor the means of taking long sights, either on a level or on hilly ground, with ease and accuracy.

The telescope is eleven inches in length and of fine quality, and may be fitted with attachments as shown, and levels and angles of elevation and depression can be taken as with the more expensive instruments.

The compass circle is moved about its center by a pinion placed above the circular plate, and the magnetic declination is set off to single minutes upon a graduated arc attached to the plate, as shown in the illustration. There is also a clamp screw, by which the circle may be made secure.

The figure represents the instrument with six inch needle. In the smaller size the vernier of the compass circle is within the box and under the glass, as in the Surveyors Transit. The needle lifting screw is underneath the plate, but is not shown in the illustration.

The levels are both above the plate, and are adjustable by castan head nuts at either end.

When used on a ball spindle, the socket is provided with a clamp screw by which the instrument is fastened on the spindle as desired.

The socket has also a spring catch fitting into a groove in the spindle and thus securing it to the instrument.

While the Vernier Transit Compass has been used ordinarily on a ball spindle, we advise the use of the leveling head, see page 163, as giving greater stability, especially

when the instrument is fitted with attachments for leveling and vertical sighting as shown in the illustration.

With this instrument horizontal angles can be measured only by the needle. When more accurate measurements are required, an instrument having a limb read by a vernier must be used.

We make two sizes of the Vernier Transit Compass, having needles five and six inches in length, respectively. The average weights are as follows:

5 in. needle, plain telescope, without leveling head	
or tripod	9 lbs.
6 in. needle, otherwise as above	11 $\frac{3}{4}$ lbs.



No. 118
VERNIER TRANSIT COMPASS
[Page 77]



ATTACHMENTS FOR TRANSITS

IN the use of the transit it is generally found advisable to add one or more attachments to the telescope. All our transits and their attachments are now made to standard sizes, so that one or more of these useful accessories can be fitted to the instrument at any time.

When any of these attachments are desired, either for our instruments or those of other makers, the instrument must be sent to us. Occasionally they can be added by a skillful mechanic nearer the customer, but this is generally more expensive and less satisfactory.

The principal attachments for the transit are:

VERTICAL CIRCLE (see pages 80-82).

VERTICAL ARC (see page 83).

LEVEL ON TELESCOPE (see page 84).

CLAMP AND TANGENT to Telescope Axis (see pages 84 and 86).

SIGHTS ON TELESCOPE (see page 86).

SIGHTS ON STANDARDS for Right Angle Observation (see page 86)

ATTACHED MAGNIFIERS to Horizontal Limb (see page 86).

BEAMAN STADIA ARC (see page 87).

GRADIENTER, combined with Clamp and Tangent (see page 89).

DETACHABLE TELESCOPES for Vertical Sighting (see page 92).

REFLECTOR for Illuminating the Cross Wires (see page 93).

DIAGONAL PRISM for Eyepiece of Telescope (see page 93).

PLUMMET LAMP (see page 94).

SOLAR ATTACHMENT to Telescope (see pages 95-127).

SOLAR SCREEN (see page 120).

VERTICAL CIRCLE



No. 136

The vertical circle is graduated on silver and figured from 0 to 90. Three sizes are generally used, the three and one half inch circle reading by vernier to five minutes, as shown in No. 118, the four and one half inch circle reading by vernier to single minutes, as shown in No. 136, and the five inch circle reading by vernier to single minutes.

To adjust the vertical circle: Having the instrument firmly set up and carefully leveled, bring into line the zeros of the circle and vernier, and with the telescope find some well defined point, from one hundred to five hundred feet distant, which is cut by the horizontal wire. Turn the instrument half way around, transit the telescope, and fixing the wire upon the same point as before, observe if the zeros are again in line. If not, loosen

the capstan head screws which fasten the vernier, and move the zero of the vernier over half the error; bring the zeros again into coincidence, and proceed exactly as before, until the error is entirely corrected.

In most cases the error is slight and may be best removed by putting the zeros in line and making the adjustment by the horizontal wire, moving it by the vertical capstan head screws until the vertical circle will reverse on the same point.

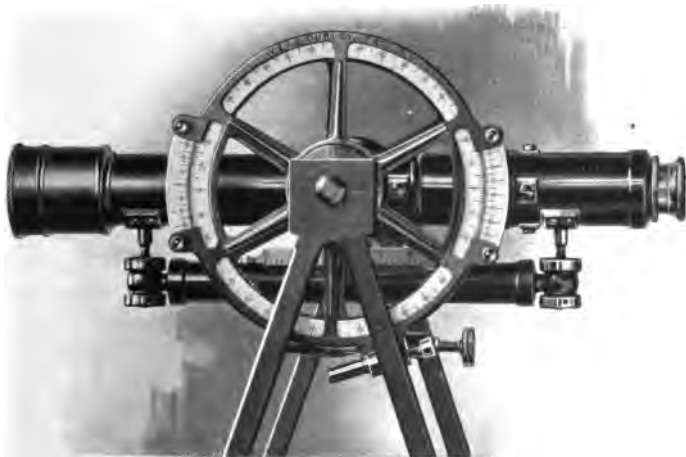

No. 138

VERTICAL CIRCLE WITH OPPOSITE VERNIERS

The five inch vertical circle may be arranged as shown in No. 138, to be read by two opposite double verniers to one minute. The verniers are supported on a ribbed frame fastened with the circle to a flange in such a manner that

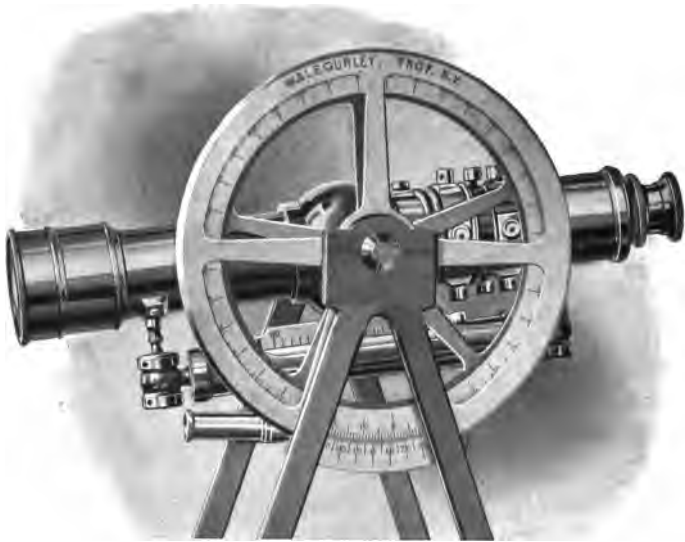

No. 141

ALUMINUM GUARD FOR VERTICAL CIRCLE

the circle is concentric with the frame, and the verniers read accurately in any position of the circle.

The frame is arranged with an adjusting screw, to bring the verniers into exact adjustment with the level on telescope.

For protecting the graduated edge of the vertical circle we make an improved guard, as shown in No. 141. This guard is of aluminum, finely finished, and so mounted on the standard as to be concentric with the circle. We can furnish this guard for all sizes of vertical circles which we make.

VERTICAL ARC

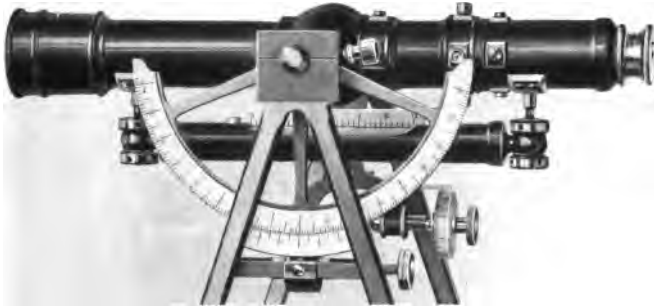

Nos. 139A, 139B and 140

The vertical arc is made in two sizes, of two and one half and three inches radius, graduated on silver and read by a vernier swung from the axis and movable by a tangent screw.

The arc is movable around its bearing on the axis, and can be readily clamped at zero with the vernier in any position of the telescope, and any degree of elevation can be read directly on the arc.

The arc of two and one half inches radius is generally used on the Light Mountain Transit, and reads by its vernier to single minutes, while the arc of three inches radius is commonly used on the larger transits, and reads by the vernier to thirty seconds. The vertical arc can be readily attached to any transit of our manufacture.

LEVEL ON TELESCOPE AND CLAMP AND
TANGENT TO TELESCOPE AXIS

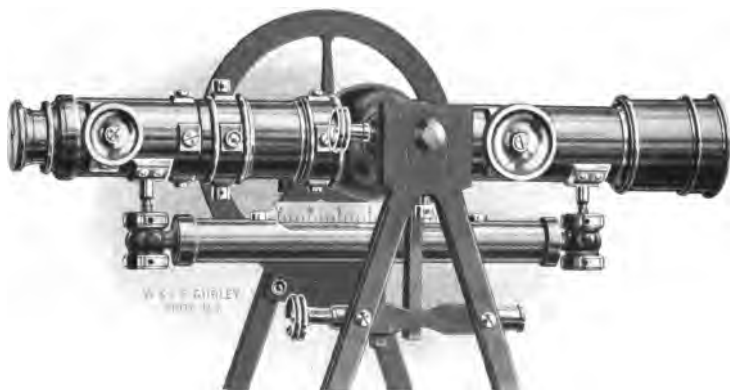

Nos. 145 and 148

The level on telescope, No. 145, consists of a brass tube about six and one half inches long, each end of which is held between two capstan nuts connected with a screw or stem attached to the under side of the telescope tube.

The vial enclosed in the tube is a little over five inches long and half an inch in diameter, and is ground on its inner surface so as to insure an even movement of the bubble, the length of which is measured by the scale above. The scale is graduated to tenths of an inch, and is figured from 0 at the middle to 5, 10, 15, on either side, thus determining when the bubble is brought into the middle of its run.

To adjust the level on telescope: When the vernier of
Adjustment the vertical circle is adjusted, as on page 80,
and is at zero, the line of collimation is
level and the bubble may be brought into the middle of its

run by the capstan head nuts. Another method is as follows: First level the instrument carefully, and with the clamp and tangent movement to the axis make the telescope as nearly horizontal as may be, by the eye. Then, having previously adjusted the line of collimation, drive a stake at a convenient distance, say from one hundred to three hundred feet, and note the height cut by the horizontal wire upon a staff set at the top of the stake.

Fix another stake in the opposite direction and at the same distance from the instrument, and without disturbing the telescope turn the instrument upon its spindle, set the staff upon the stake, and drive the stake into the ground until the same height is indicated as in the first observation. The tops of the two stakes will then be in the same horizontal line, however much the telescope may be out of level.

Remove the instrument from fifty to one hundred feet to one side of either of the stakes and in line with both. Again level the instrument, clamp the telescope as nearly horizontal as may be, and note the heights indicated upon the staff placed first upon the nearest and then upon the most distant stake. If both agree, the telescope is level. If they do not agree, with the tangent screw move the wire over nearly the whole error, as shown at the distant stake, and repeat the operation just described. Proceed thus until the horizontal wire will indicate the same height at both stakes, when the telescope will be truly horizontal. Taking care not to disturb the position of the telescope, bring the bubble into the middle by the little leveling nuts at the end of the tube, when the adjustment will be complete.

CLAMP AND TANGENT

The clamp and tangent, No. 148, consists of an arm at one end encircling the telescope axis, and at the other end connected with the tangent screw. The clamp is fastened at will to the axis by a clamp screw inserted at one side of the ring, and by turning the tangent screw the telescope may be raised or lowered.

The clamp and tangent must always accompany the vertical circle and level on telescope, whenever either is used on a transit.

SIGHTS ON TELESCOPE AND ON STANDARDS

For convenience in observation, we occasionally place a pair of small sights No. 157 on the telescopes of our transits. These sights have folding joints, that they may lie close to the telescope when not in use. Sights No. 158 may also be placed on the standards at an angle of ninety degrees with the telescope, for use in offsetting.

ATTACHED MAGNIFIERS

Attached magnifiers are frequently used over the verniers of the horizontal or vertical limb, and are held by a universal three jointed arm, which allows the lens to be placed over any point of the vernier.

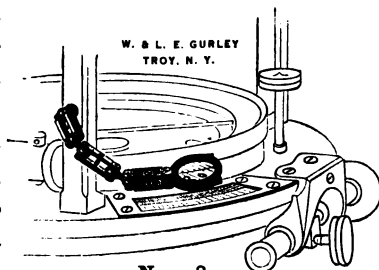

BEAMAN STADIA ARC*Patented March 27, 1906***No. 149**

This new and specially graduated vertical arc furnishes engineers with a rapid and exact mechanical solution of the stadia problem, since by its use precise differences in elevation, and reduced horizontal distances, can be determined with great rapidity, without the use of any of the adjuncts in stadia surveying heretofore necessary.

This arc was devised in 1904 by W. M. Beaman, a topographer in the U. S. Geological Survey, and is now extensively used by that bureau in its topographical surveys. It can be attached to the vertical arc of any Transit of our manufacture.

The Beaman Stadia Arc has two scales: a multiple scale, V, by the use of which the grade per hundred feet of observed stadia distance may be determined, and a reduction scale, H, giving the percentage of correction necessary to reduce observed stadia distance to true horizontal distance.

We furnish this stadia arc attached to the vertical limbs of new transits or telescopic alidades, or fit it to such instruments sent to us for that purpose and to which it can be adapted. The price of the arc, when fitted to an old instrument, will depend on the cost of attaching, and will be quoted after examination of the instrument.

ADVANTAGES OF THE STADIA ARC

1. The use of stadia tables, slide rules, or diagrams is entirely obviated.
2. There is no vernier or similar contrivance to be read.
3. Final results are obtained in less than one third the time required by ordinary methods.
4. The accuracy of results is identical with formulæ or table computations, regardless of the angle or distance.
5. The simplicity of the process practically eliminates the chances of error incidental to the use of other methods.

A more detailed description of the Beaman Stadia Arc and its use, as well as a general discussion of the subject of stadia surveying, is found in the special circular on Stadia Surveying which we publish, and which we furnish free of charge on application.

GRADIENTER

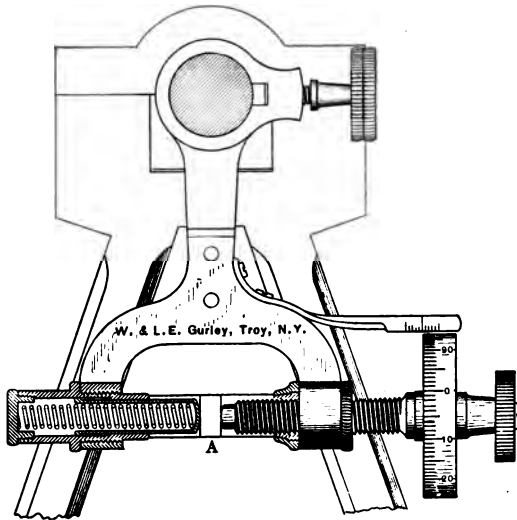

No. 150

This attachment is often used with the transit for determining distances, fixing grades and similar work.

It consists mainly of a screw attached to the expanded arm of the ordinary clamp of the telescope axis. This screw is accurately cut, and, passing through a nut in one side of the arm, presses against a stud, A, fixed to the inside surface of the right hand standard. In the side of the arm opposite the screw is an enclosed spiral spring which presses against the side of the stud, securing a positive movement of the gradienter screw.

Near the other end of the screw, and turning with it, is a wheel or micrometer, the rim of which is covered with silver, and graduated into one hundred equal parts. A silver scale, attached to the arm and just above the micrometer wheel, is graduated into spaces, each of which is equal to one revolution of the screw; so that by comparing the edge of the wheel with the graduations of the scale, the number of complete revolutions of the screw can be easily counted.

When the clamp is made fast to the axis, the gradienter screw will serve as an ordinary tangent screw to incline the **Measuring** telescope. As the value of its screw thread is **Distances** such that a complete revolution of the screw will move the horizontal cross wire of the telescope over a space of one foot on a vertical rod at a distance of one hundred feet, it is clear that when the screw is turned through fifty spaces on the graduated head, the wire will pass over fifty hundredths, or one half a foot on the rod, and so on in the same proportion. In this way the gradienter can be used in the measurement of distances.

To avoid the possibility of error, observations should be taken by turning the screw always in the same direction for the same series of observations.

Grades can be established with great facility as follows: Level the instrument, and bring the telescope level bubble to the middle by the clamp and gradienter screw. **Grades** Move the graduated head until its zero is brought to the edge of the scale; then turn off as many spaces on the head as there are hundredths of feet to the hundred in the grade to be established.

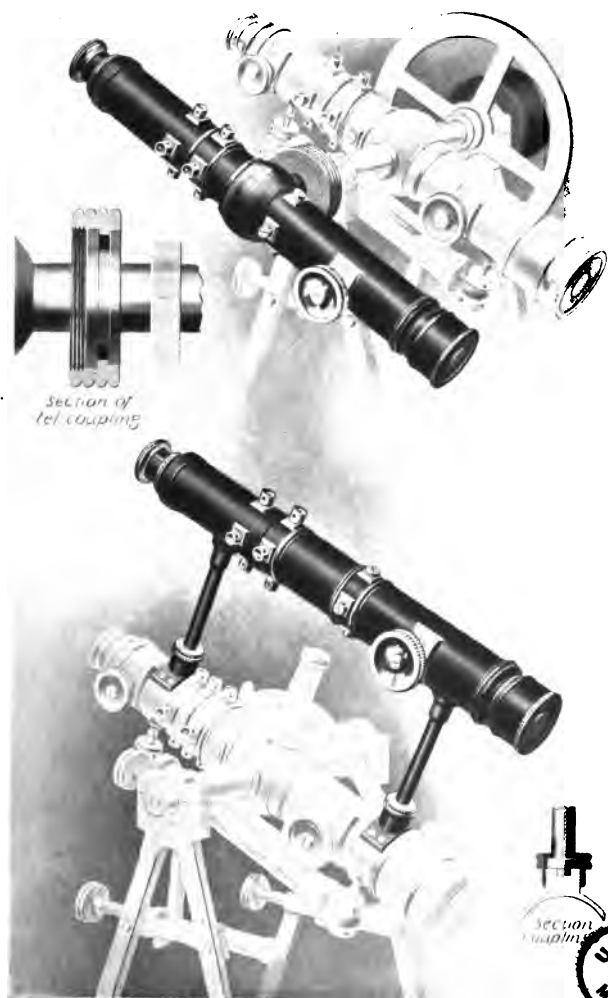

Nos. 160 and 161

[Page 91]

DETACHABLE TELESCOPES FOR VERTICAL SIGHTING

A convenient arrangement for sighting up or down a vertical shaft is shown in No. 160, in which an extra telescope is fitted with a flange and disk connecting it with the axis, so as to make it precisely parallel with the main telescope. A counterpoise, as shown, is fitted to the other end of the axis, and both telescope and counterpoise can be detached and placed in the transit box when not in use.

In No. 161, the extra telescope is connected with the main telescope by coupling nuts, which fasten it directly over the center of the instrument and allow its ready removal and replacement without disturbing its adjustments. In both arrangements the extra telescope is adjusted to the main telescope of the transit so that the lines of collimation of both are parallel and in the same plane, horizontal in No. 160 and vertical in No. 161; and in both the extra telescope swings over the outside of the transit plates. The diagonal prism is often used with the extra telescope for greater convenience in sighting.

The reflectors, Nos. 165 and 166, are elliptical pieces of silver inclined at an angle of forty five degrees with the ring, which is fitted to the objective end of the telescope. The opening in the reflector allows the use of the telescope, while a light held near the inner surface illuminates the cross wires.



Nos. 165 and 166
REFLECTOR

The diagonal prism, No. 168, is used when it is necessary to observe greater vertical angles than can be taken with the ordinary telescope. It consists of a prism attached to the cap of the eyepiece, by which the object is presented to the eye when placed at right angles with the telescope. When the telescope is directed to the sun the slide



No. 168
DIAGONAL
PRISM

or darkener containing colored glass is moved over the opening.

The circular plate to which the prism is attached is made to turn in the cap, so that, when it is substituted for the ordinary cap of the eyepiece, the opening of the prism can be easily adjusted to the position of the eye. Observations can be taken with the prism up to an angle of sixty degrees elevation.

The Plummet Lamp, No. 170, is a large plummet, of Plummet which the upper Lamp part is hollow to contain oil. It has a tube for a wick, and an extinguisher.

It is hung in gimbals by chains with a hook, and so always assumes a vertical position, and when suspended from the shifting center of a leveling head it can be easily adjusted over a given point.

These lamps are packed in a wooden case, furnished with a strap to sling over the shoulders. The weight of each lamp is about one and one quarter pounds, and either one, two, or three may be packed in a single box.



No. 170
PLUMMET LAMP

SOLAR ATTACHMENT

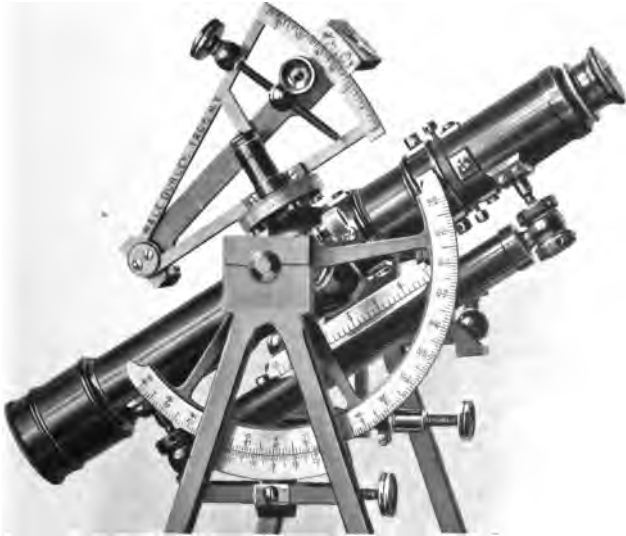

No. 190

THE solar attachment is essentially the solar apparatus of Burt placed upon the cross bar of the transit. A disk one and one half inches in diameter, having a pivot projecting above its upper surface, is screwed to the telescope axis. Upon this pivot rests the enlarged base of the polar axis, which is firmly connected with the disk by four capstan head screws passing from the under side of the disk into the base. These screws serve to adjust the polar axis, as will be explained hereafter.

The hour circle surrounding the base of the polar axis is easily movable about it, and can be fastened at any point desired by two flat head screws above. It is graduated to five minutes of time, is figured from I to XII, and is read by an index fixed to the declination arc and moving with it. A hollow cone or socket, fitting the polar axis and made to move upon it, or to be clamped at any point desired by a milled head screw on top, furnishes by its arms below a firm support for the declination arc, which is fastened to it.

The declination arc has a radius of about five inches, and is graduated to quarter degrees. On the Mountain Transit it reads by vernier to single minutes, and on the larger transits to half minutes, the graduations of both vernier and limb being in the same plane. The declination arc has the usual lenses and silver plate on the two opposite blocks, also a clamp and tangent movement, as shown in the illustration. The arc of the declination limb is turned on its axis and one or the other solar lens used, as the sun is north or south of the equator. The illustration shows its position when the sun is north.

The latitude is set off by means of a large vertical limb figured from the center each way in two rows, from 0 to 80 and from 90 to 10, the first series being intended for reading vertical angles, and the second series for setting off the latitude. The vernier of the vertical limb is made movable by the tangent screw attached, so that its zero and that of the limb are readily made to coincide when, in adjusting the limb to the level of the telescope, the arc is clamped to the axis.

The usual tangent movement to the telescope axis serves to incline the telescope to the proper angle, as hereafter

described. A level on the under side of the telescope, with ground vial and scale, is indispensable in the use of the solar attachment. The arcs, verniers, and hour circle are all graduated on silver.

See pages 128 to 133 for definitions of astronomical terms.

EXPLANATION OF THE SOLAR ATTACHMENT

When the telescope is set horizontal by its spirit level, the hour circle will be in the plane of the horizon, the polar axis will point to the zenith, and the zeros of the vertical arc and its vernier will coincide. If we incline the telescope, directed north, the polar axis will descend from the direction of the zenith. The angle through which it moves, being laid off on the vertical arc, will be the co-latitude of the place where the instrument is used, the latitude itself being found by subtracting this number from ninety degrees.

When the sun passes above or below the equator, its declination, or angular distance from it, as given in the Ephemeris, can be set off upon the declination arc, and its image brought into position as before.

In order to do this, however, it is necessary not only that the latitude and declination be correctly set off upon their respective arcs, but also that the instrument be moved in azimuth until the polar axis points to the pole of the heavens, or, in other words, is placed in the plane of the meridian. Thus the position of the sun's image will indicate not only the latitude of the place, the declination of the sun for the given hour, and the apparent time, but it will also determine the meridian, or true north and south line passing through the place where the observation is made.

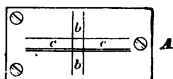

The interval between two equatorial lines, $c c$, as well as between the hour lines, $b b$, is just sufficient to include the circular image of the sun, as formed by the solar lens on the opposite end of the revolving arm.

Declination Allowance for declination: Let us now suppose the observation made when the sun has passed the equinoctial point, and when its position is affected by declination.

By referring to the Ephemeris, and setting off on the arc the declination for the given day and hour, we are still able to determine its position with the same certainty as if it remained on the equator.

When the sun's declination is south, that is, from the 22d of September to the 20th of March in each year, the arc is turned downward, or toward the plates of the transit, while during the remainder of the year the arc is turned from the plates.

When the solar attachment is accurately adjusted and the transit plates precisely horizontal, the latitude of the place and the declination of the sun for the given day and hour being set off on their respective arcs, and the instrument set approximately north by the magnetic needle, the image of the sun cannot be brought between the equatorial lines until the polar axis is placed in the plane of the meridian of the place, or in a position parallel with the axis of the earth. The slightest deviation from this position will cause the image to pass above or below the lines, and thus discover the error.

From the position of the sun in the solar system we thus obtain a direction absolutely unchangeable, from which to run lines and measure horizontal angles.

This simple principle is not only the basis of the construction of solar instruments, but it is the sole cause of their superiority over instruments having only the magnetic needle. For in an instrument having a magnetic needle, the accuracy of the horizontal angles indicated, and therefore of all the observations made, depends upon the delicacy of the needle and the constancy with which it assumes a certain direction, called the magnetic meridian.

The principal causes of error in the needle are the dulling of the pivot and the resulting injury to the jeweled center, **Error in Needle** loss of polarity in the needle, the influence of local attraction, and the effect of the sun's rays producing the diurnal variation. From all these imperfections the solar instrument is free.

The latitude of the place and the declination of the sun being set off upon their respective arcs, we are able not only to run the true meridian, or a due east and west course, but also to set off horizontal angles with minuteness and accuracy from a direction which never changes and which is unaffected by attraction.

ADVANTAGES OF THE SOLAR ATTACHMENT

From what has been said, the surveyor will readily understand that the more perfect horizon obtained by the use of the telescope level, and the use of a telescope in place of sights, render the attachment more accurate than the Solar Compass.

The attachment can be added to the telescope of any good transit at a comparatively small expense, thus enabling the surveyor to establish the true meridian, to determine the correct latitude, and to obtain true time very nearly.

Its adaptation to the purposes of illustration and instruction in practical astronomy in colleges and schools will occur

to every teacher; and it furnishes for the government surveyor a long sought and much needed instrument, superior to the Solar Compass formerly used.

In experiments made by us, an error of one quarter of a minute in the direction of the true meridian, or in latitude, can be easily detected by observing the sun's image through a magnifier, and we feel confident that any one who uses the solar attachment will be satisfied with its work.

The weight of the solar attachment is but little more than ten ounces, and is so distributed as not to disturb the counterpoise of the instrument, thus obviating the objection which has hitherto prevented the successful use of the telescope with the solar apparatus. When not in use the attachment should be removed from the telescope and packed in the instrument box, and the thin sheath put on the polar axis and kept in its place by the screw and washer of the socket.

It is evident that all transits to which the solar attachment is to be added should have a horizontal limb and verniers, and should be furnished with a level on telescope, clamp and tangent to telescope axis, and vertical arc and vernier. They should also have a movable compass circle to set off the magnetic declination, and should be leveled by leveling screws. They must be in perfect order, especially in respect to the sockets, before correct work can be done.



No. 17
ENGINEERS SOLAR TRANSIT, TWO VERNIERS TO LIMB
[Page 101]

TO

and
day
Epl
tele
the
cas
nor
tov
wit
arr
br

an
scr
tri
C
es
is
an
as

m
of
te
er
re
ol

TO RUN LINES WITH THE SOLAR ATTACHMENT

Having set off the latitude of the place on the vertical arc, and the declination, corrected for refraction, for the given day and hour as computed from the tables in the Solar Ephemeris, the instrument being also carefully leveled by the telescope bubble, set the horizontal limb at zero and clamp the plates. Loosen the lower screw so that the transit moves easily upon its lower socket, set the instrument approximately north and south, with the objective end of the telescope toward the north, turn the proper solar lens to the sun, and, with one hand on the plates and the other on the revolving arm, move them from side to side until the sun's image is brought between the equatorial lines on the silver plate.

The lower clamp of the instrument should now be fastened, and any further lateral movement be made by the tangent screw of the leveling head. The telescope will now be in the true meridian, and may be used like the sights of the Solar Compass, but with far greater accuracy and satisfaction in establishing meridian lines. When the upper or vernier plate is unclamped from the limb, an angle read by the verniers is an angle from the meridian; and thus parallels of latitude or any other angles from the true meridian may be established, as with the Solar Compass.

The bearing of the needle, when the telescope is on the meridian, will also give the magnetic declination at the point of observation.

Observations may be made with the object end of the telescope depressed, pointed north, again with the eyepiece end depressed, pointing south, or again with the telescope reversed and the attachment on the other side — two other observations.

Thus with four distinct observations we may take the mean and eliminate any possible error of adjustment.

If the instrument has a movable compass circle, as in our Surveyors Transits, the magnetic declination can be set off to single minutes, the needle kept at zero, or with the sun, and lines be run by the needle alone when the sun is obscured.

REFRACTION IN DECLINATION

The Table of Refractions on pages 105 to 109 is calculated for latitudes between $2\frac{1}{2}^{\circ}$ and 70° at intervals of $2\frac{1}{2}^{\circ}$, that being as near as is required.

The declination ranges from 0° to 20° both north and south, the + declinations being north and the - south, and is given for every 5° , that being sufficiently near for all practical purposes. The hour angle in the first column indicates the distance of the sun from the meridian in hours, the refraction given for 0 hours being that which affects the observed declination of the sun when on the meridian, commonly known as meridional refraction. The refraction for the hour just before or after noon is so nearly that of the meridian that it may be called and allowed as the same.

When the table is used, it must be borne in mind that when the declination is north, or + in the table, the refraction is to be added; when the declination is south, or -, the refraction must be subtracted. It will be noticed that the refraction in south, or -, declination increases very rapidly as the sun nears the horizon, showing that observations should not be taken with the sun when it is south of the equator, less than one hour from the horizon.

A TABLE OF MEAN REFRACTIONS IN DECLINATION

To apply on the declination arc of solar attachment of
either compasses or transits.

Computed by EDWARD W. ARMS, C. E., for W. & L. E. GURLEY, Troy, N. Y.

HOUR ANGLE	DECLINATIONS								
	FOR LATITUDE 2° 30'								
	+20°	+15°	+10°	+5°	0°	-5°	-10°	-15°	-20°
0 h.	-18"	-12"	-07"	-02"	+02"	07"	12"	18"	23"
2	-18	-12	-07	-02	+02	07	12	18	23
3	-17	-11	-06	-01	+03	08	13	19	25
4	-15	-10	-05	0	+05	10	15	21	27
5	-10	-05	0	+05	10	15	20	26	32
FOR LATITUDE 5°									
0 h.	-15"	-10"	-05"	0"	+05"	10"	15"	20"	27"
2	-15	-10	-05	0	+05	10	15	20	27
3	-13	-08	-03	+02	07	12	17	23	29
4	-10	-05	0	+05	10	15	20	27	32
5	-05	0	+05	10	15	20	27	32	40
FOR LATITUDE 7° 30'									
0 h.	-13"	-08"	-02"	+02"	08"	13"	18"	24"	29"
2	-12	-07	-01	+03	09	14	19	25	31
3	-10	-05	0	+05	10	15	20	26	32
4	-05	0	+05	10	15	20	26	32	39
5	+07	12	17	23	29	36	43	51	1'01
FOR LATITUDE 10°									
0 h.	-10"	-05"	0"	+05"	10"	15"	20"	26"	32"
2	-07	-03	+02	07	12	17	22	28	34
3	-05	0	+03	08	13	19	25	31	38
4	0	05	10	15	20	26	32	39	46
5	+15	20	26	32	39	46	55	1'06	1'19
FOR LATITUDE 12° 30'									
0 h.	-08"	-02"	+02"	08"	13"	18"	24"	30"	36"
2	-06	0	+05	10	15	20	26	32	39
3	+02	07	12	17	23	29	36	43	51
4	04	09	14	20	25	31	40	48	55
5	21	27	33	40	48	57	1'08	1'23	1'41

HOUR ANGLE	DECLINATIONS								
	FOR LATITUDE 15°								
	+20°	+15°	+10°	+5°	0°	-5°	-10°	-15°	-20°
0 h.	-05"	0"	+05"	10"	15"	21"	27"	33"	40"
2	-03	+02	07	12	18	23	29	36	43
3	+01	05	11	16	22	28	34	41	49
4	08	12	19	24	30	37	44	53	1'04
5	29	34	41	49	59	1'10	1'24	1'43	2'08

FOR LATITUDE 17° 30'									
0 h.	-02"	+02"	08"	13"	18"	24"	30"	36"	44"
2	0	05	10	15	21	27	33	40	48
3	+02	10	15	21	27	33	40	48	57
4	13	18	23	29	35	43	51	1'01	1'13
5	34	41	49	58	1'10	1'23	1'41	2 06	2 42

FOR LATITUDE 20°									
0 h.	0"	05"	10"	15"	21"	27"	33"	40"	48"
2	03	07	13	18	24	30	36	44	52
3	06	13	18	24	30	36	44	52	1'02
4	17	22	28	35	42	50	1'00	1'11	1 26
5	39	47	57	1'07	1'20	1'37	2 00	2 32	3 25

FOR LATITUDE 22° 30'									
0 h.	02"	08"	13"	18"	24"	30"	36"	44"	52"
2	06	11	15	21	27	33	40	48	57
3	11	15	21	27	33	40	48	57	1'08
4	20	26	32	39	46	56	1'07	1'19	1 37
5	45	53	1'03	1'16	1'31	1'52	2 21	3 07	4 28

FOR LATITUDE 25°									
0 h.	05"	10"	15"	21"	27"	33"	40"	48"	57"
2	08	14	19	25	31	38	46	54	1'05
3	12	18	24	30	37	44	53	1'04	1 18
4	23	29	35	45	53	1'03	1'16	1 31	1 52
5	49	59	1'10	1'24	1'52	2 07	2 44	3 46	5 43

FOR LATITUDE 27° 30'									
0 h.	08"	13"	18"	24"	30"	36"	44"	52"	1'02"
2	11	16	22	28	34	41	49	1'00	1 10
3	17	22	28	35	42	50	1'00	1 11	1 26
4	28	35	42	50	1'00	1'11	1 26	1 43	2 09
5	54	1'05	1'18	1'34	1 54	2 24	3 11	4 38	8 15

FOR LATITUDE 30°									
0 h.	10"	15"	21"	27"	33"	40"	48"	57"	1'08"
2	14	19	25	31	38	46	54	1'05	1 18
3	20	26	32	39	47	55	1'06	1 19	1 36
4	32	39	46	52	1'06	1'19	1 35	1 57	2 29
5	1'00	1'10	1'24	1'52	2 07	2 44	3 46	5 43	13 06

TRANSIT INSTRUMENTS

107

HOUR ANGLE	DECLINATIONS								
	FOR LATITUDE 32° 30'								
	+20°	+15°	+10°	+5°	0°	-5°	-10°	-15°	-20°
0 h.	13"	18"	24"	30"	36"	44"	52"	1'02"	1'14"
2	17	22	28	35	42	50	1'00	1 11	1 26
3	23	29	35	43	51	1'01	1 13	1 28	1 47
4	35	43	51	1'01	1'13	1 27	1 46	2 13	2 54
5	1'03	1'15	1'31	1 53	2 20	3 05	4 25	7 36	
FOR LATITUDE 35°									
0 h.	15"	21"	27"	33"	40"	48"	57"	1'08"	1'21"
2	20	25	32	38	46	55	1'05	1 18	1 35
3	26	33	39	47	56	1'07	1 21	1 38	2 00
4	39	47	56	1'07	1'20	1 36	1 59	2 32	3 25
5	1'07	1'20	1'38	2 00	2 34	3 29	5 14	10 16	
FOR LATITUDE 37° 30'									
0 h.	18"	24"	30"	36"	44"	52"	1'02"	1'14"	1'29"
2	22	28	35	42	50	1'00	1 12	1 26	1 45
3	29	36	43	52	1'02	1 14	1 29	1 49	2 16
4	43	51	1'01	1'13	1 27	1 49	2 14	2 54	4 05
5	1'11	1'26	1 44	2 10	2 49	3 55	6 15	14 58	
FOR LATITUDE 40°									
0 h.	21"	27"	33"	40"	48"	57"	1'08"	1'21"	1'39"
2	25	32	39	46	52	1'06	1 19	1 35	1 57
3	33	40	48	57	1'08	1 21	1 38	2 02	2 36
4	47	55	1'06	1'19	1 36	1 58	2 30	3 21	4 59
5	1'15	1'31	1 51	2 20	3 05	4 25	7 34	25 18	
FOR LATITUDE 42° 30'									
0 h.	24"	30"	36"	44"	52"	1'02"	1'14"	1'29"	1'49"
2	28	35	39	50	1'00	1 12	1 26	1 45	2 11
3	36	43	52	1'02	1 13	1 29	1 49	2 17	2 59
4	50	1'00	1'11	1 26	1 44	2 10	2 49	3 55	6 16
5	1'19	1 36	1 58	2 30	3 22	5 00	9 24		
FOR LATITUDE 45°									
0 h.	27"	33"	40"	48"	57"	1'08"	1'21"	1'39"	2'02"
2	32	39	46	52	1'06	1 19	1 35	1 57	2 29
3	40	47	56	1'07	1 21	1 38	2 00	2 34	3 29
4	54	1'04	1'16	1 33	1 54	2 24	3 11	4 38	8 15
5	1'23	1 41	2 05	2 41	3 40	5 40	12 02		
FOR LATITUDE 47° 30'									
0 h.	30"	36"	44"	52"	1'02"	1'14"	1'29"	1'49"	2'18"
2	35	42	50	1'00	1 12	1 26	1 45	2 01	2 51
3	43	51	1'01	1 13	1 28	1 47	2 15	2 56	4 08
4	56	1'09	1 23	1 40	2 05	2 40	3 39	5 37	11 18
5	1'27	1 46	2 12	2 52	4 01	6 30	16 19		

HOUR ANGLE		DECLINATIONS								
		FOR LATITUDE 50°								
		+20°	+15°	+10°	+5°	0°	-5°	-10°	-15°	-20°
0 h.	33"	40"	48"	57"	1'08"	1'21"	1'39"	2'02"	2'36"	
2	38	46	55	1'06	1 18	1 35	1 57	2 28	3 19	
3	47	56	1'06	1 19	1 36	2 29	2 31	3 23	5 02	
4	1'02	1'14	1 29	1 48	2 16	2 58	4 18	6 59	19 47	
5	1 30	1 51	2 19	3 04	4 22	7 28	24 10			
HOUR ANGLE		FOR LATITUDE 52° 30'								
		36"	44"	52"	1'02"	1'14"	1'29"	1'49"	2'18"	3'05"
		0 h.	36"	44"	52"	1'02"	1'14"	1'29"	1'49"	2'18"
2	43	50	59	1 11	1 26	1 42	2 23	2 49	3 55	
3	50	1'00	1'11	1 26	1 45	2 11	2 51	2 58	6 22	
4	1'05	1 18	1 35	2 10	2 28	3 19	4 53	8 42		
5	1 34	1 56	2 27	3 16	4 47	8 52				
HOUR ANGLE		FOR LATITUDE 55°								
		40"	48"	57"	1'08"	1'21"	1'39"	2'02"	2'36"	3'33"
		0 h.	40"	48"	57"	1'08"	1'21"	1'39"	2'02"	2'36"
2	46	55	1'05	1 18	1 34	1 56	2 30	3 15	4 47	
3	55	1'06	1 19	1 35	1 58	2 30	3 21	4 58	9 19	
4	1'10	1 23	1 42	2 06	2 43	3 44	5 49	12 41		
5	1 37	2 01	2 34	3 28	5 15	10 18				
HOUR ANGLE		FOR LATITUDE 57° 30'								
		44"	52"	1'02"	1'14"	1'29"	1'49"	2'18"	3'05"	4'37"
		0 h.	44"	52"	1'02"	1'14"	1'29"	1'49"	2'18"	3'05"
2	50	59	1 11	1 25	1 43	2 09	2 47	3 51	6 04	
3	58	1'10	1 24	1 42	2 07	2 43	3 45	5 50	12 47	
4	1'11	1 25	1 43	2 10	2 50	3 55	6 14	14 49		
5	1 41	2 06	2 42	3 42	5 46	12 26				
HOUR ANGLE		FOR LATITUDE 60°								
		48"	57"	1'08"	1'21"	1'39"	2'02"	2'36"	3'33"	5'23"
		0 h.	48"	57"	1'08"	1'21"	1'39"	2'02"	2'36"	3'33"
2	54	1'04	1 17	1 33	1 54	2 24	3 12	4 38	8 15	
3	1'03	1 15	1 30	1 51	2 20	3 04	4 24	7 31	24 44	
4	1 18	1 34	1 56	2 28	3 18	4 50	8 53			
5	1 45	2 11	2 50	3 57	6 21	15 32				
HOUR ANGLE		FOR LATITUDE 62° 30'								
		52"	1'02"	1'14"	1'29"	1'50"	2'18"	3'00"	4'17"	7'13"
		0 h.	52"	1'02"	1'14"	1'29"	1'50"	2'18"	3'00"	4'17"
2	58	1 09	1 23	1 41	2 06	2 43	3 44	5 50	12 44	
3	1'07	1 23	1 38	2 01	2 35	3 30	5 16	10 24		
4	1 23	1 40	2 05	2 40	3 40	5 37	11 50			
5	1 48	2 17	2 59	4 14	7 03					
HOUR ANGLE		FOR LATITUDE 65°								
		57"	1'08"	1'21"	1'39"	2'02"	2'36"	3'33"	5'23"	10'51"
		0 h.	57"	1'08"	1'21"	1'39"	2'02"	2'36"	3'33"	5'23"
2	1'03	1 16	1 31	1 52	2 21	3 07	4 28	7 44		
3	1 12	1 27	1 46	2 12	2 52	4 02	6 33			
4	1 27	1 47	2 13	2 54	4 05	6 40				
5	1 52	2 22	3 08	4 30	7 52					

		DECLINATIONS								
		FOR LATITUDE 67° 30'								
HOUR ANGLE										
	+20°	+15°	+10°	+5°	0°	-5°	-10°	-15°	-20°	
0 h.	1'02"	1'14"	1'29"	1'50"	2'18"	3'00"	4'17"	7'13"		
2	1 08	1 22	1 40	2 03	2 39	3 37	5 32	11 28		
3	1 17	1 34	1 55	2 26	3 14	4 44	8 34			
4	1 32	1 53	2 23	3 14	4 35	8 05				
5	1 56	2 28	3 17	4 40	8 51					
		FOR LATITUDE 70°								
0 h.	1'08"	1'21"	1'39"	2'02"	2'36"	3'33"	5'23"	10'51		
2	1 14	1 29	1 50	2 18	3 00	4 17	7 13			
3	1 23	1 43	2 05	2 41	3 41	5 59	12 15			
4	1 37	2 00	2 34	3 28	5 20	10 12				
5	2 02	2 33	3 27	5 11	10 05					

TO COMPUTE THE DECLINATION

Suppose the corrected declination is desired for the different hours of October 15, 1912, at Troy, N. Y. The latitude is $42^{\circ} 44'$. The longitude is practically five hours; so that the declination given in the Ephemeris for apparent noon of that day at Greenwich would be that for 7 A. M. at Troy, or five hours earlier. Note carefully the algebraic signs. The declination is south or minus. Its hours difference is minus. The refraction always is plus. Hence we use the algebraic sum, thus: —

S	$8^{\circ} 28' 56^{\circ}.5$	is the tabular declination for			7 A. M.
	$55^{\circ}.6$	— hr. diff.			
	$8^{\circ} 29' 52^{\circ}.1$	+ ref.	(4 hrs.)	$2' 29'' = -$	$8^{\circ} 27' 23''$, 8 A. M.
	$55^{\circ}.6$				
	$8^{\circ} 30' 47^{\circ}.7$	+ ref.	(3 hrs.)	$1' 39'' = -$	$8^{\circ} 29' 09''$, 9 A. M.
	$55^{\circ}.6$				
	$8^{\circ} 31' 43^{\circ}.3$	+ ref.	(2 hrs.)	$1' 19'' = -$	$8^{\circ} 30' 24''$, 10 A. M.
	$55^{\circ}.6$				
	$8^{\circ} 32' 38^{\circ}.9$	+ ref.	(1 hr.)	$1' 07'' = -$	$8^{\circ} 31' 32''$, 11 A. M.
	$55^{\circ}.6$				
	$8^{\circ} 33' 34^{\circ}.5$	+ ref.	(0 hr.)	$1' 07'' = -$	$8^{\circ} 32' 27''$, 12 M.
	$55^{\circ}.6$				
	$8^{\circ} 34' 30^{\circ}.1$	+ ref.	(1 hr.)	$1' 07'' = -$	$8^{\circ} 33' 23''$, 1 P. M.
	$55^{\circ}.6$				
	$8^{\circ} 35' 25^{\circ}.7$	+ ref.	(2 hrs.)	$1' 19'' = -$	$8^{\circ} 34' 07''$, 2 P. M.
	$55^{\circ}.6$				
	$8^{\circ} 36' 21^{\circ}.3$	+ ref.	(3 hrs.)	$1' 39'' = -$	$8^{\circ} 34' 42''$, 3 P. M.
	$55^{\circ}.6$				
	$8^{\circ} 37' 16^{\circ}.9$	+ ref.	(4 hrs.)	$2' 29'' = -$	$8^{\circ} 34' 48''$, 4 P. M.

Again, suppose the corrected declination is desired for the different hours of May 15, 1912, at Troy. Now the declination is north or plus and the hourly difference is plus.

N	18° 50' 51".6	+	ref.	(5 hrs.)	1' 27" =	+ 18° 52' 19",	7 A. M.
	35".5		add hr. diff.				
+	18° 51' 27".1	+	ref.	(4 hrs.)	55" =	+ 18° 52' 22",	8 A. M.
	35".5						
+	18° 52' 02".6	+	ref.	(3 hrs.)	40" =	+ 18° 52' 43",	9 A. M.
	35".5						
+	18° 52' 38".1	+	ref.	(2 hrs.)	32" =	+ 18° 53' 10",	10 A. M.
	35".5						
+	18° 53' 13".6	+	ref.	(1 hr.)	26" =	+ 18° 53' 39",	11 A. M.
	35".5						
+	18° 53' 49".1	+	ref.	(0 hr.)	26" =	+ 18° 54' 15",	12 M.
	35".5						
+	18° 54' 24".6	+	ref.	(1 hr.)	26" =	+ 18° 54' 50",	1 P. M.
	35".5						
+	18° 55' 00".1	+	ref.	(2 hrs.)	32" =	+ 18° 55' 32",	2 P. M.
	35".5						
+	18° 55' 35".6	+	ref.	(3 hrs.)	40" =	+ 18° 56' 16",	3 P. M.
	35".5						
+	18° 56' 11".1	+	ref.	(4 hrs.)	55" =	+ 18° 57' 06",	4 P. M.
	35".5						
+	18° 56' 46".6	+	ref.	(5 hrs.)	1' 27" =	+ 18° 58' 14",	5 P. M.

We believe it will be found that the use of the table as illustrated above will not only relieve the surveyor of the perplexity hitherto attending the subject of refractions, but will also enable him to secure more accurate results than were possible by the methods usually given.

The calculation of the declination for the different hours of the day should, of course, be made and noted before the surveyor begins his work, that he may lay off the change from hour to hour, from a table prepared as before described.

TO FIND THE LATITUDE

Level the instrument very carefully, using the level of the telescope, until the bubble will remain in the middle during a complete revolution of the instrument, the tangent movement of the telescope being used in connection with the leveling screws, and the axis of the telescope being firmly clamped.

Clamp the vertical arc, so that its zero and the zero of its vernier coincide as near as may be, and bring them into exact line by the tangent screw of the vernier.

Set off upon the proper arc the declination of the sun for noon of the given day, corrected for the meridional refraction. Note the equation of time, and fifteen or twenty minutes before noon direct the telescope to the north and lower the objective end until the sun's image can be brought nearly into position between the equatorial lines, by moving the instrument upon its spindle and the declination arc from side to side.

The declination arc being brought directly in line with the telescope, clamp the axis, and with the tangent screw of the telescope axis bring the image precisely between the lines, following the sun's motion as the image runs below the lower equatorial line, or, in other words, as long as the sun continues to rise in the heavens.

When the sun reaches the meridian the image will remain stationary in altitude for an instant, and will then begin to rise on the plate.

The moment the image ceases to run below is apparent

noon, when the index of the hour arc should indicate XII, and the latitude be determined by the reading of the vertical arc.

The angle through which the polar axis has moved in the operation just described is measured from the zenith instead of the horizon, as in the Solar Compass, so that the angle read on the vertical limb is the complement of the latitude.

The latitude itself is readily found by subtracting this angle from 90° . Thus at Troy the reading of the limb being found as above directed to be $47^\circ 16'$, the latitude will be $90^\circ - 47^\circ 16' = 42^\circ 44'$. The latitude may also be read direct by referring to the inner row of figures on the arc, beginning with 90 in the middle and reading to 10 on either side.

TIME FOR USING THE SOLAR

While the solar can be used with advantage at all seasons of the year, the most favorable time is the summer, when the declination is north and the days are long and more generally fair. It is best not to take the sun at morning and evening when it is within half an hour of the horizon, nor at noon for about the same interval before and after it passes the meridian.

ADVANTAGES OF THE SOLAR IN SURVEYING

While the solar is indispensable in the survey of public lands, it also possesses important advantages over the magnetic needle compass when used in the surveys of farms, and similar work. Not only can lines be run and angles be measured without regard to the diurnal variation or the effect of local attraction, but the bearings, being taken from the true meridian, will remain unchanged for all time.

In favorable weather surveys can be made more rapidly than with the needle instrument, there being no time consumed in waiting for the needle to settle, or in avoiding the errors due to local attraction.

When the sun is obscured the lines can be run by the needle alone, it being always kept with the sun, or at 0 on its arc, thus indicating the direction of the true meridian. The sun, however, must be regarded as the most reliable guide, and should, if possible, be taken at every station.

TELESCOPIC SOLAR ATTACHMENT

WHEN a continued series of solar observations are to be made, it is sometimes important that, when taken, these need not be referred to the main telescope of the transit.

We have recently introduced a telescopic solar to meet such requirements; the solar attachment once being adjusted, the main telescope of the transit may be used independently and solar observations taken with no other adjustment than for the hourly change of declination.

The new telescopic solar, as shown in the illustration, consists of an attachment whereby the sun is viewed through a telescope giving a magnified image. This telescope has a movement about itself which constitutes the polar axis and follows the apparent movement of the sun in time. The angle of the reflector is adjustable in declination and the whole movable about a latitude axis.

The attachment is mounted on the side of the transit standard and is so arranged that the several parts are independently adjustable and in their relation with each other occupy the least possible space.

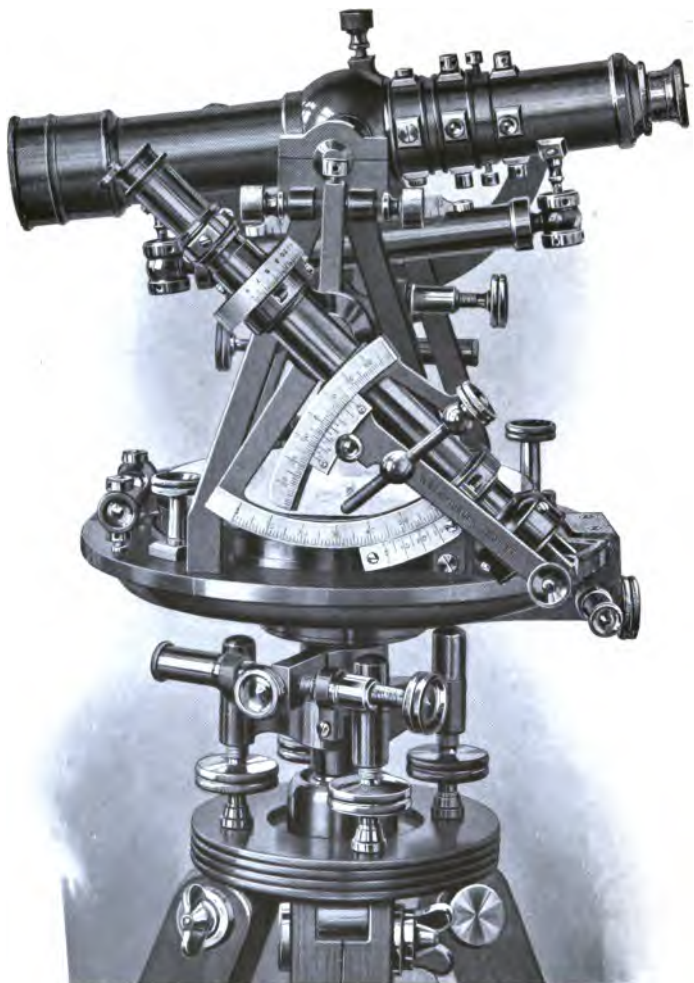

No. 32
TELESCOPIC SOLAR

[Page 116]

TO ADJUST THE TELESCOPIC SOLAR

1. Unscrew the tangent screw of the declination arc from the nut and remove the reflector, together with its axis, by unscrewing the caps at its bearings.

2. Adjust the line of collimation by revolving the telescope in its bearings, using as distant a point as possible.

3. Cause the telescope to trace a vertical line and align with the main telescope by adjustment of the four capstan head screws of the axis of the frame.

4. With the main telescope leveled, its line and that of the solar telescope should agree; if not, adjust the solar telescope by moving the tangent screw of the latitude arc. When the two lines are coincident, the latitude arc should read 0.

5. Replace the reflector and tangent screw of the declination arc. Lay off two points ninety degrees apart, one should be in good illumination, a point projecting above the sky line is to be preferred. Set the main telescope on one point and get the reflected image of the other point through the solar telescope, moving it by means of the tangent screw of the declination arc. The declination arc should then read 0.

6. Lay off the latitude and corrected declination on their respective arcs and bring the sun's image inscribed in the cross wires by revolving the transit about its vertical axis, and the solar telescope about its axis. The instrument is now on the meridian from which any angle may be taken. There is no further change except the hourly change of declination.

DIRECT OBSERVATION ON THE SUN

With a transit having both vertical and horizontal limbs, direct observations may be taken on the sun to find the meridian. The best time is about three hours before or after noon. A colored or smoked glass darkener will be necessary over the eyepiece to protect the eye. The observations to be taken are those of the altitude of the sun and its horizontal angle from a fixed point, at the same instant. It is best to take a number of these, say three or five, so as to check; and if the telescope is reversed and another set taken, the mean of the two sets will eliminate many inaccuracies. It is also an advantage to use the lower limb of the sun in the morning and the upper limb in the afternoon, it being easier to judge the tangency of image and cross wires. Allowance is then made for the semi-diameter of the sun, which varies from $15\frac{3}{4}$ to $16\frac{1}{4}$ minutes. It will be sufficiently close to have the vertical wire bisect the sun, but the altitude must be taken with care. The transit must be accurately leveled and adjusted.

To reduce the observations there are many forms, all deduced from the same formula. The form much favored is

$$\tan^2 \frac{1}{2}A = \frac{\sin [S - (90^\circ - \text{alt.})] \cdot \sin [S - (90^\circ - \text{lat.})]}{\sin S \cdot \sin [S - (90^\circ - \text{dec.})]}$$

Reduction Formula In which "A" is the azimuth of the sun or horizontal distance from the meridian, and "S" is one half the sum of $(90^\circ - \text{alt. corrected for refraction}) + (90^\circ - \text{lat.}) + (90^\circ - \text{dec.})$. Note the sign of the declination. When South would be $90^\circ - (-\text{dec.}) = 90^\circ + \text{dec.}$

EXAMPLE: Place, Troy, N. Y. Time, 3h. 30m. P. M.,
March 31, 1910.

The horizontal angle from a fixed point to sun's center . 241° 46'
 Observed altitude of upper limb of sun 30° 31' 10"
 Obs. alt.—refraction 1' 40"—semi-diameter 16' = alt. of
 sun's center 30° 13' 30"
 Declination for day and hour 4° 02' 58"
 Latitude 42° 44'
 90°—alt. = 59° 46' 30", 90°—dec. = 85° 57' 02",
 90°—lat. = 47° 16', 2 S = 192° 59' 32" S = 96° 29' 46"
 log. sin [S—(90°—alt.)] = 9.77664
 log. sin [S—(90°—lat.)] = 9.87923
 9.65587
 log. sin S = 9.99720
 log. sin [S—(90°—dec.)] = 9.26251
 9.25971
 log. tan² ½ A = 0.39616
 log. tan ½ A = 0.19808
 ½ A = 57° 38' 06" and A = 115° 16' 12" west of North.

If in the morning would be east of North.

Apply this to the horizontal angle from the fixed point to the sun and we have 357° 02' 12", which is the reading of the horizontal limb when the telescope is pointed North. Set this reading off on the limb and the telescope will be in the plane of the meridian.

A Table of Mean Refractions due to Altitude.

Bar. 30 ins., Ther. 50° F.

App. alt.	Ref.	App. alt.	Ref.	App. alt.	Ref.	App. alt.	Ref.
5°	9' 46"	10°	5' 16"	20°	2' 37"	50°	0' 48"
6°	8' 23"	12°	4' 25"	25°	2' 03"	60°	0' 33"
7°	7' 20"	14°	3' 47"	30°	1' 40"	70°	0' 21"
8°	6' 30"	16°	3' 19"	35°	1' 22"	80°	0' 10"
9°	5' 49"	18°	2' 56"	40°	1' 09"	90°	0' 0"

A Table of Semi-Diameters of the Sun

Jan. 1, 16' 18''	April 1, 16' 02''	July 1, 15' 46''	Oct. 1, 16' 01''
Feb. 1, 16' 16''	May 1, 15' 54''	Aug. 1, 15' 48''	Nov. 1, 16' 09''
Mar. 1, 16' 10''	June 1, 15' 48''	Sept. 1, 15' 53''	Dec. 1, 16' 15''



No. 192 SOLAR SCREEN

If desired, a solar screen is furnished, arranged to clamp to the eyepiece end of the telescope, and detachable at will.

Solar Screen On this screen the image of the sun and cross wires can be readily observed, a greater movement of the eyepiece, however, being required.

PATENT LATITUDE LEVEL

This attachment, shown in the illustration of No. 30, is used for recovering the latitude on a solar transit without referring to the vertical arc, and also for setting the telescope at any desired angle in running grades and similar work.

It consists of a level connected by a short conical socket with the end of the telescope axis, to which it is clamped by a milled head screw, and made adjustable by a tangent screw and spring on the enlarged end of the tube. When the clamp screw is released the level turns vertically upon the axis, and can thus be set at any angle with the telescope, the final adjustment being made by the tangent screw.

The latitude being set off upon the vertical arc as usual, the level is clamped and brought into the middle, as above described.

The telescope may then be released and used in running lines, until it is desired to recover the latitude again. This is easily and accurately done without referring to the vertical arc. The use of the attachment in running any desired grade is readily understood.

This attachment is furnished without extra charge with any new solar instrument.



JONES LATITUDE ARC

When this attachment is used the vertical arc is omitted, and is replaced by a double latitude arc attached to the under side of the telescope, as shown. The smaller arc, having its center directly under the cross bar of the telescope, has an arm with vernier reading the arc to single minutes, and carries also a level tube open at both top and bottom, with a scale over each opening.

In obtaining latitudes with this attachment, the declination being set off as usual, the level bubble should be brought into the middle of its scale when the sun is on the meridian.

The reading of the smaller arc then gives the latitude of the place, and in all further observations of the latitude reference is made to the level rather than to the graduations, the level being easily brought into the middle of the scale. This

enables the surveyor to recover the latitude more rapidly than with the ordinary vertical arc.

Minute changes, as long lines are run either north or south, may be computed and set off on the larger arc, which reads by its vernier to ten seconds.

But one test of the adjustment of this attachment is required, that both arcs should read zero when the telescope is made horizontal by its long level, and the smaller level of the arc below is also brought to the middle of its scale.

If not correct, they may be adjusted by loosening the screws which fasten each arc, and moving the arcs until the zeros of both are in coincidence with the zeros of their verniers, care being taken to set the screws firmly again.

TO ADJUST THE SOLAR ATTACHMENT

To adjust the solar attachment, proceed as follows:

Solar Lenses and Lines Detach the declination arm by taking off the clamp and tangent screws, and removing the center by which the arm is pivoted on the arc.

Substitute for the declination arm upon the attachment the adjusting bar furnished with every solar instrument, the center of the declination arm fitting into the hole at one end of the bar, and the bar being further secured to the attachment by the clamp screw passing through the hole in the declination arc left by the removal of the tangent screw, into the threaded hole at the other end of the adjusting bar, thus forming a support upon which the declination arm can be adjusted.

Place the declination arm on the adjuster, turn one end to the sun, and bring it into such a position that the image of the sun is made to appear precisely between the equatorial lines on the opposite plate.

Carefully turn the arm over, until it rests upon the adjuster by the opposite faces of the rectangular blocks, and again observe the sun's image. If it remains between the lines as before, the arm is in adjustment. If not, loosen the three small screws and move the silver plate under their heads until one half the error in the position of the sun's image is removed.

Bring the image again between the lines, and repeat the operation as above on both ends of the arm, until the image will remain between the lines of the plate in both positions of the arm, when it will be in proper adjustment, and the arm may be replaced in its former position on the attachment. This adjustment is very rarely needed in our instruments, the lenses being cemented in their cells and the plates securely fastened.

To adjust the vernier of the declination arc: Set the **Declination** vernier at zero, and raise or lower the tele-
Arc scope until the sun's image appears exactly between the equatorial lines.

Having the telescope axis clamped, carefully revolve the arm until the image appears on the other plate. If precisely between the lines, the adjustment is complete. If not, move the declination arm by its tangent screw until the image will come precisely between the lines on the two opposite plates. Clamp the arm and remove the index error by loosening two screws that fasten the vernier; place the zeros of the vernier and limb in exact coincidence, tighten the screws, and the adjustment is complete.

To adjust the polar axis: Level the instrument carefully by the long level of the telescope, using the tangent movement of the telescope axis in connection with
Polar Axis the leveling screws, until the bubble will remain in the middle during a complete revolution of the instrument upon its axis.

Place the solar attachment upon the axis and see that it moves easily around it. Bring the declination arm into the same vertical plane with the telescope, place the adjusting level, No. 196 (see page 126), upon the top of the rectangular blocks, and bring the bubble of the level into the middle by the tangent screw of the declination arc.

Turn the arc half way around, bringing it again parallel with the telescope, and note the position of the level. If in the middle, the polar axis is vertical in that direction. If not in the middle, correct one half the error by the capstan head adjusting screws under the base of the polar axis, moving each screw of the pair the same amount, but in an opposite direction. Bring the level to the middle again by the tangent

screw of the declination arc, and repeat the operation as before, until the bubble will remain in the middle when the adjusting level is reversed.

Pursue the same course in adjusting the arc in the second position, or over the telescope axis, and when completed the



No. 196

STRIDING OR ADJUSTING LEVEL

level will remain in the middle during an entire revolution of the arc, showing that the polar axis is at right angles with the level under the telescope, or truly vertical.

As this is by far the most delicate and important adjustment of the solar attachment, it should be made with the greatest care, the bubble being kept precisely in the middle and frequently inspected in the course of the adjustment.

The adjusting level is supposed to be itself in adjustment; but if not, it can be easily corrected by the screw shown at one end, when reversed upon a plane surface, exactly as a mason's level is adjusted.

To adjust the hour arc: Whenever the instrument is set in the meridian, as will be hereafter described, the index of the hour arc should read apparent time. If not, loosen the two flat head screws on the top of the hour circle, and with the hand turn the circle around until the proper reading is indicated, fasten the screws again, and the adjustment will be complete.

ASTRONOMICAL TERMS

IN the following pages we define the terms employed in the use and adjustment of the solar attachment, which may be helpful to one not familiar with solar instruments.

Sun The sun is the fixed center of the solar system, although for convenience it is often spoken of as in motion around the earth.

The earth makes a complete revolution around the sun in three hundred and sixty five days, five hours, forty eight minutes, and forty six seconds. It also rotates about
Earth an imaginary line passing through its center, and termed its axis, once in twenty three hours, fifty six minutes, and four seconds, mean time, turning from west to east.

The poles are the extremities of the axis. That in our hemisphere, known as the north pole, if produced indefinitely
Poles toward the concave surface of the heavens, would reach a point near the polar star, called the north pole of the heavens.

The equator is an imaginary line passing around the earth, equidistant from the poles, and in a plane at right angles
Equator with the axis. If the plane of the equator were produced to the heavens, it would form what is called the celestial equator.

The orbit of the earth is the path in which it
Orbit moves in its yearly revolution. If the plane of this orbit were produced to the heavens, it would form the ecliptic, or the sun's apparent path in the heavens.

The earth's axis is inclined to its orbit at an angle of

about $23^{\circ} 27'$, making an angle of the same degree between the earth's orbit and its equator or between the celestial equator and the ecliptic.

Equinoxes The equinoxes are the two points at which the ecliptic and the celestial equator intersect one another.

The declination of the sun is its angular distance north or south of the celestial equator. When the sun is at the **Declination of the Sun** equinoxes, about the 21st of March and the 21st of September of each year, its declination is 0, or it is said to be on the equator. From these points its declination gradually increases, until on the 21st of June and the 21st of December it is $23^{\circ} 27'$ distant from the equator.

It is the declination which causes the sun to appear so much higher in summer than in winter, its altitude in the heavens being about $46^{\circ} 54'$ more on the 21st of June than it is on the 21st of December.

The horizon of a place is the visible boundary of a plane, tangent to the earth at that place, or at right angles to a vertical line. The horizon, or a horizontal surface, is determined by the surface of a liquid at rest, or by the spirit levels of an instrument.

Zenith The zenith of a place is the point directly overhead, in a line at right angles with the horizon.

Meridian The meridian circle of a place is a great circle passing through the zenith of that place and the poles of the earth.

The meridian, or true north and south line, is the line determined by the intersection of the plane of the meridian circle with the plane of the horizon.

Meridian Altitude The meridian altitude of the sun is its angular elevation above the horizon, when passing the meridian of the place.

Latitude The latitude of a place is its angular distance north or south of the equator, measured on the meridian. At the equator the latitude is 0° , and at the poles 90° .

Longitude The longitude of a place is its angular distance east or west of a given place taken as the starting point, or first meridian. It is measured on the equator or on any parallel of latitude.

In the Nautical Almanac, which is commonly used with a solar instrument, the longitude of the principal places in the United States is reckoned from Greenwich, England, and expressed both in degrees and hours.

Zenith Distance The zenith distance of any heavenly body is its angular distance north or south of the zenith of a place, measured when the body is on the meridian.

Suppose a person to be on the equator at the time of an equinox; the sun, when on the meridian, would be in the zenith of the place, and the poles of the earth would lie in the plane of its horizon.

Disregarding, for the present, the declination of the sun, let us suppose that the person travels toward the north pole. As he passes to the north, the sun will descend from the zenith, and the pole will rise from the horizon in the same proportion, until when he arrives at the north pole of the earth the sun will have declined to the horizon, and the pole of the heavens will have reached the zenith.

The altitude of the pole at any place, or the distance of

the sun from the zenith, would, in the case supposed, give the observer the latitude of that place.

If we now take into account the sun's declination, it will increase or diminish its meridian altitude, according as it passes north or south of the equator; but the declination of the sun at any time being known, its zenith distance, and therefore the latitude of the place, can be readily ascertained by an observation made when the sun is on the meridian. It is by this method that we obtain the latitude of any place by the Solar Compass.

A solar day is the interval of time between the departure of the sun from the meridian of a place and its succeeding return to the same position. The length of the solar day, by reason of the inclination of the earth's axis, is constantly changing.

In order to have a uniform measure of time, we have recourse to what is termed a mean solar day, the length of which is equal to the mean or average of all the solar days in a year.

The time thus given is called mean solar time, and is the same at any instant for all points on the same meridian, differing, however, at points on different meridians.

Since November, 1883, in the United States, the mean solar times of the meridians 60° , 75° , 90° , 105° , and 120° west of Greenwich are adopted as standard time, and are called respectively Colonial, Eastern, Central, Mountain, and Pacific time. The time of each place differs from that of the next by one hour. Instead of employing the local mean solar time, the time used is the mean solar time at the nearest of the standard meridians.

At Troy, N. Y., the longitude is $73^{\circ} 40'$ west, or four

hours, fifty four minutes and forty seconds; hence the mean solar time is five minutes and twenty seconds more than the standard time. At Minneapolis the longitude is six hours, twelve minutes and fifty seven seconds; hence the mean solar time is twelve minutes and fifty seven seconds less than standard time, since the city is west of the meridian.

Equation of Time The sun is sometimes faster and sometimes slower than the clock, the difference being called the equation of time.

The moment when the sun is on the meridian of any place is called apparent noon, and this being ascertained, we can, by adding the equation of time for the given day to, or subtracting it from, apparent noon, according as the sun is slow or fast, obtain the time of mean noon, which, converted to standard time, is used to set the watch.

As the earth makes a complete rotation upon its axis once a day, every point on its surface must pass through three hundred and sixty degrees in twenty four hours, or fifteen degrees in one hour, and so on in the same ratio. As the rotation is from west to east, the sun would come to the meridian of every place fifteen degrees west of Greenwich just one hour later than the time given in the Ephemeris for apparent noon at Greenwich.

To an observer at Troy, N. Y., the longitude of which is, in time, four hours, fifty four minutes, forty seconds, the sun would come to the meridian nearly five hours later than at Greenwich, and thus, when it was 12 M. at that place it would be only about 7 A. M. in Troy.

Refraction By reason of the atmosphere, the rays of light from the sun are bent out of their course, so as to make its altitude appear greater than is actually the case.

The refraction varies according to the altitude of the body observed, being zero when it is in the zenith, about one minute when midway from the zenith to the horizon, and almost thirty four minutes when in the horizon. The proper allowance to be made for refraction in setting off the declination is fully explained on pages 105 to 112.

If the latitude and declination of the sun were both zero, the position of the sun at noon would be at the zenith and there would be no refraction. At any other latitude, declination or hour, the apparent position of the sun would be lower and refraction must be taken into account. As refraction is due to altitude, it might be suggested to lay it off directly on the vertical limb; but as this would alter the inclination of the polar axis, it must be laid off on the declination arc, and modified to suit the proper inclination of the arc due to latitude, declination, and hour angle.

Again, the angles which the equatorial lines make with the horizon are continually changing, as the declination arm is made to follow the course of the sun during an entire day. Thus in the morning and evening the equatorial lines are more or less inclined to the horizon, while at noon they are parallel with it. It follows that the excess of refraction at morning and evening is in some measure balanced by the fact that the position of the sun's image with reference to the equatorial lines is then less affected by it, on account of the greater inclination of the lines to the horizon.

SOLAR COMPASS

THIS instrument was invented by William A. Burt, of Michigan, and patented by him in 1836. It came into general use in the surveys of the United States public lands, the principal lines of which are required to be run with reference to the true meridian.

The invention long since became public property, and for more than sixty years the Solar Compass has been manufactured by us, with improvements of our own in construction and in design which have made it increasingly popular and efficient.

The arrangement of the sockets and plates is similar to that of the Surveyors Transit, as shown on page 58, except that the sight vanes are attached to the under plate or limb, and this revolves around the upper or vernier plate on which the solar parts are placed.

The limb is graduated to half degrees, is figured in two rows, 0 to 360 and 0 to 90 each way, and reads by two opposite double verniers to single minutes. The graduations of the limb and all other arcs of the Solar Compass are made on silver.

This instrument should always be used on a tripod, with screws for ready and accurate leveling, and a tangent screw for directing it to any desired point. For this purpose a leveling head with tangent screw, similar to that shown in the illustration of the Surveyors Transit, is furnished with every instrument.

Weight The Solar Compass with leveling head, but without tripod, weighs about fifteen pounds.

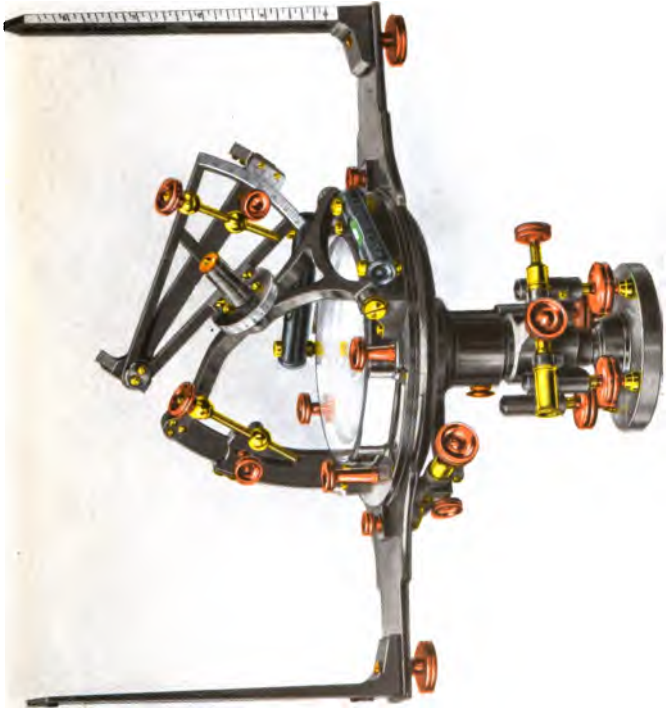

NO. 210
SOLAR COMPASS, TWO VERNIERS TO LIMB
[Page 135]



at
ar
de

ve

ti

m

ti

er

di

p

p

k

s

z

t

v

c

l

,

!

THE SOLAR APPARATUS

The solar apparatus is mounted over the needle, and operates as its substitute in the field. It consists mainly of three arcs, by which can be set off the latitude of a place, the declination of the sun, and the hour of the day.

TO ADJUST THE SOLAR COMPASS

The adjustments of this instrument with which the surveyor should be familiar are few and simple, as follows:

To adjust the levels: Proceed as directed in the description of other instruments, by bringing the bubbles into the middle of the tubes by the leveling screws, and then reversing the instrument upon its spindle and raising or lowering the ends of the tubes, until the bubbles will remain in the middle during a complete revolution of the instrument.

To adjust the equatorial lines and solar lenses: See page 124.

To adjust the vernier of the declination arc: See page 125.

To adjust the solar apparatus to the compass sights: First level the instrument, and with the clamp and tangent screws set the main plate at ninety degrees by the verniers and horizontal limb. Remove the clamp and tangent screws of the latitude arc, and raise the arc until the polar axis is by estimation very nearly horizontal, and, if necessary, tighten the screws on the pivots of the arc, so as to hold it in this position.

Fix the vernier of the declination arc at zero, and direct the outside edges of the lens blocks to some distant and well marked object, and observe it through the compass sights. If the same object is seen by both observations, and

the verniers read to ninety degrees on the limb, the adjustment is complete. If not, the correction must be made by moving the compass sights or changing the position of the verniers.

As the solar parts are attached permanently to the sockets, and this adjustment is made by the manufacturer, it will need no attention at the hands of the surveyor, except in case of serious accident. The other adjustments are also made in the process of finishing the instrument, and are not liable to derangement in careful use.

TO RUN LINES WITH THE SOLAR COMPASS

Having set off the latitude and declination upon their respective arcs and the instrument being in adjustment, the surveyor is ready to run lines by the sun.

To do this, the instrument is set over the station and carefully leveled, the plates clamped at zero on the horizontal limb, and the sights directed north and south, the direction being approximated when unknown by the needle.

The solar lens is then turned to the sun, and, with one hand on the instrument and the other on the revolving arm,

True Meridian both are moved from side to side, until the sun's image appears on the silver plate, precisely between the equatorial lines. The line of sight will then indicate the true meridian, and the observation may be made and the flagman put in position.

When a due east and west line is to be run, the verniers of the horizontal limb are set at ninety degrees, and the sun's image kept between the lines, as before.

The Solar Compass being so constructed that when the sun's image is in position the limb must be clamped at zero

in order to run a true meridian line, it will be evident that the bearing of any line from the meridian may be read by the verniers of the limb precisely as in the transit.

In running lines, the magnetic needle may be kept with the sun, that is, the point of the needle is made to indicate zero on the compass, by turning the pinion to the variation arc. Lines can thus be run by the needle alone in case of the temporary disappearance of the sun, but the surveyor must be sure that there is no local attraction. The magnetic declination, which should be noted at every station, is read off on the variation arc of the compass circle by its vernier.

In using the Solar Compass, if the revolving arm be turned a little to one side of its proper position, a false or reflected image of the sun will appear on the silver plate in nearly the same place as that occupied by the true one. It is caused by the reflection of the true image from the surface of the arm, and is a fruitful source of error to the inexperienced surveyor. It can, however, be readily distinguished from the real image by its being less bright, and not so clearly defined.

SUPERIORITY OF OUR SOLAR COMPASS

The Solar Compass as first made, though planned with great ingenuity in its general arrangement, was extremely rude in its mechanical details and adjustments.

The points in which we claim the superiority of our Solar Compass over any other manufactured are partially shown in the illustration of No. 210, and may be stated in detail as follows:

1. A motion of the horizontal plates entirely free from friction, combined with perfect rigidity.
2. A tangent movement to the limb, as shown under the plate.
3. A tangent movement with clamp to the declination arc.
4. A tangent movement with clamp to the latitude arc.
5. A tangent movement for the whole instrument about its socket.
6. Increased facility of adjustment, and therefore an important saving of time.
7. A complete circle for compass needle.

RAILROAD COMPASS

THE Railroad Compass is an instrument intended for land surveying in localities where it is necessary to measure horizontal angles independently of the needle, as in cases of local attraction.

The accuracy and minuteness of the horizontal angles indicated by this instrument, together with its perfect adaptation to all the purposes for which the Vernier Compass can be used, have brought it into use in many localities where land is so valuable as to require more careful surveys than are practicable with a needle instrument.

This instrument is a compass of the highest grade, with a graduated limb and verniers like those of the transit. As shown on the following page, it has the main plate, levels, sights, and needle of the ordinary compass, and, in addition, underneath the main plate, a graduated circle or limb by which horizontal angles to single minutes can be taken independently of the needle. The limb is figured in two rows, 0 to 360 and 0 to 90 each way.

The arrangement of the sockets is like that of the Surveyors Transit with two verniers to limb, and the plates can be separated and replaced in the same manner.

The verniers are attached to the under surface of the main plate at an angle of thirty degrees with the line of sights, the vernier openings being covered with glass to protect the graduations from dust and moisture.

The connection between the two plates is made by a

clamp and tangent movement with opposing spring, shown at *t* underneath the plates.

The needle lifting screw is shown at *n*, on the left of the plate. On the right of the compass circle is seen the head of a pinion working into a rack fixed to the edge of the compass circle, enabling the surveyor to move it about its center in setting off the magnetic declination, as described on page 145. The declination is read to single minutes by a vernier and graduated arc, partially shown in the illustration.

A clamp screw is shown at *c*, by which the circle may be securely fixed when moved to the proper position.

The telescopic sight, hereafter described, is often used with the Railroad Compass with excellent results.

We make two sizes of this instrument, with needles respectively five and five and one half inches in length. The
Sizes and Weights smaller size, including the brass head of the staff, weighs thirteen pounds, and the larger size weighs about fourteen pounds.

TO USE THE RAILROAD COMPASS

To secure the best results, the Railroad Compass should never be used without a tripod.

On this the compass may be supported either by the plain spindle or, better, by the tangent ball, as shown on page 162. The instrument may also be used upon the leveling head with clamp and tangent movement and tripod, and this is preferable to any other support. (See page 163.)

To take horizontal angles: Having leveled the plate and set the limb at zero, fix the sights upon one of the objects
Horizontal Angles selected, and, clamping the whole instrument to the spindle, unclamp the vernier plate and turn it with the hand until the sights are brought nearly upon

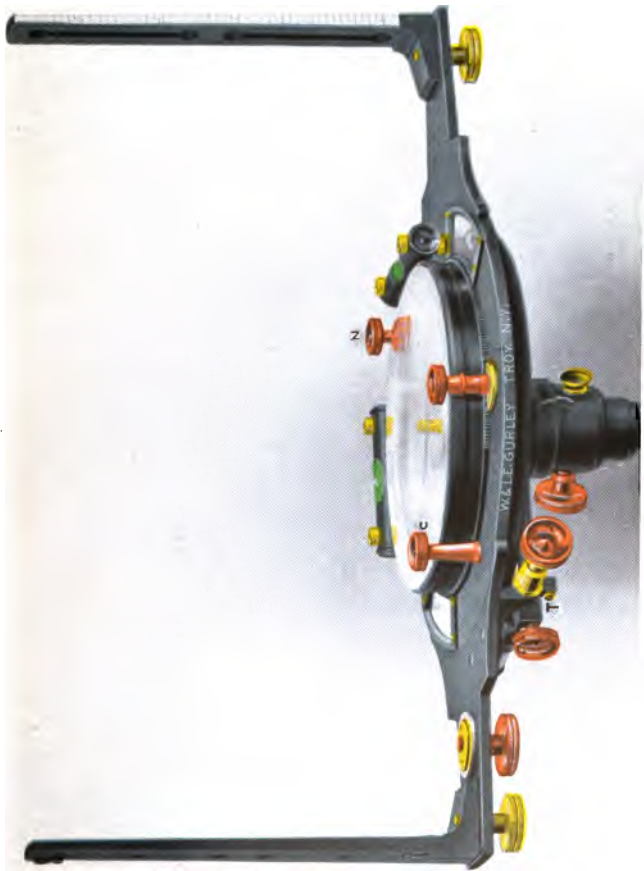

No. 216
RAILROAD COMPASS, TWO VERNIERS TO LIMB
[Page 143]





the second object; then clamp to the limb, and with the tangent screw fix them precisely upon it. The number of degrees and minutes read off by the vernier will give the angle between the two objects, taken from the center of the instrument.

It will be understood that horizontal angles can be taken in any position of the verniers with reference to the zero point of the limb. We have given that above as being the usual method and the one least liable to error.

Where extreme accuracy is required, it is advisable, in this and other instruments which have two verniers, to obtain the readings of the limb from both, add the two together and halve their sum. The result will be the mean of the two readings, and the true angle between the points observed.

In taking horizontal angles, the magnetic bearings of the two objects are often noted, and thus two separate readings of the same angle, one by the limb and the other by the needle, are obtained, to be used as checks upon each other to prevent mistakes.

To set off the magnetic declination: Having leveled the instrument, set the limb at zero and place the sights upon the old line, note the reading of the needle, and make it agree with that given in the field notes of the former survey by turning the compass circle about its center by the pinion head. Clamp the compass circle, and the number of degrees or minutes passed over by the vernier of the circle will be the change of magnetic declination in the interval between the two surveys.

To survey with this instrument, the operator should turn the south end of the compass toward his person, and having brought the zeros of the limb and vernier plate in line, clamp the plates, and proceed as directed in the account of the Vernier Compass.

It will be remembered that lines can be run and angles measured by the graduated limb and verniers, independently of the needle; and in places where local attraction is manifested this is very desirable.

RAILROAD COMPASS, ONE VERNIER TO LIMB

This instrument is essentially like that just described, but of somewhat simpler construction in its sockets. It is in every way accurate and reliable, although offered at a price materially lower than that of the compass with two verniers.

We make but one size of this instrument, which has a five and one half inch needle, and weighs about thirteen pounds.

VERNIER COMPASS

THIS instrument, No. 227, has its compass circle, to which is attached a vernier, movable about its center a short distance in either direction, enabling the surveyor to set the zeros of the circle at any required angle with the line of sights. The number of degrees contained in this angle, or the declination of the needle, is read off by the vernier.

The compass circle is graduated to half degrees on its upper surface, the whole degree marks being also cut down on the inside circumference, and is figured from 0 to 90 on each side of the line of zeros. The circle and face of the compass are silvered. The movement of the circle is effected by a rack and pinion, the head of which projects from the under side of the main compass plate. When the declination is set off as described, the circle is fastened in its position by a clamp screw.

Vernier The vernier is graduated on its edge into thirty equal parts, and figured in two series on each side of the middle line.

In the same plane with the vernier is an arc or limb, fixed to the main plate of the compass, and graduated to half degrees. Each space on the vernier is one minute shorter than a single space on the limb. The surfaces of both vernier and limb are silvered.

The spirit levels are placed at right angles with each other so as to level the plate in all directions, and are balanced upon a pivot under the middle of the tube, so as to be adjustable by a screw driver.

Underneath the main plate is a needle lifting screw which, by moving a concealed spring, raises the needle from the pivot, and thus prevents the blunting of the point in transportation.

When the compass is not in use, it is the practice of many surveyors to let down the needle upon the point of the center pin, and allow it to assume its position in the magnetic meridian, so as to retain its polarity. We advise that after the needle has settled it be raised against the glass, in order not to dull the point of the center pin.

A small dial plate, having an index turned by a milled head underneath, is used with this and other compasses to keep tally in chaining. The dial is figured from 0 to 16, the index being moved one notch for every chain run.

A brass cover is fitted over the glass of the compass, and serves to protect it from accident, as well as to prevent electric disturbance.

The sights, or sight vanes, have fine slits cut through nearly their whole length, terminated at intervals by circular apertures, through which the object sighted upon is more readily found. Sometimes a horse hair or wire is substituted for half the slit, and placed alternately with it on opposite sights, at an extra charge of \$5.00.

The telescopic sight is often used with the Vernier Compass, and its adjustments and use are described on pages 165 to 171.

The right and left edges of the north sight of our compasses are graduated to half degrees for angles of elevation and depression respectively, which are read from corresponding peep holes on the south sight.



No. 227
VERNIER COMPASS
[Page 149]

The

ies c

The

i. an

al Sp

any

aced

e co

A l

ore c

Th

entic

zaff I

pro

lamp

any l

Be

t ou

Sprin

istri

W

seedl

Sizes

the s

I

are

Con

The illustration shows the eyepiece and graduations for angles of elevation.

The compass is fitted to a spindle made slightly conical, and having on its lower end a ball turned perfectly

Ball Spindle spherical, and confined in a socket by a pressure so light that the ball can be moved in any direction in leveling the compass. The ball is placed either in the brass head of the staff, or better, in the compass tripod.

A leveling adopter, shown on page 162, is often used for more convenient leveling of the compass.

The staff mountings consist of the brass head already mentioned, and a pointed steel shoe. The staff, to which the

Staff Mountings mountings should be securely fastened, may be procured from any wheelwright, or provided by the surveyor himself.

Clamp Screw In the side of the hollow socket of the compass is a screw by which the instrument may be clamped to the spindle in any position.

Besides the clamp screw there is fitted to the sockets of our compasses a spring catch, which, as soon as the in-

Spring Catch strument is set upon its spindle, slips into a groove, and thus removes all danger of the instrument falling from the spindle while being carried.

We make three sizes of the Vernier Compass, having needles respectively four, five, and six inches long, the main

Sizes plates being respectively twelve and one half, fifteen, and fifteen and one half inches long. The sights of the smallest are about an inch shorter than the others.

In the four and five inch Vernier Compasses, the variation arc is within the compass circle, like that of the Railroad Compass, and the magnetic declination is set off to minutes

by a pinion head underneath the plate, this arc being clamped by a screw placed opposite the pinion.

The average weights of the different sizes, including the brass head of the staff, are respectively six and one quarter, eight and three quarters, and ten and one half pounds.

USE OF THE VERNIER

The superiority of the Vernier over the Plain Compass consists in its adaptation to retracing the lines of an old survey, and to the surveys of the United States public lands, in which the lines are based on a true meridian.

In reading the vernier, if it is moved to the right, count the minutes from its zero point to the right, and vice versa. To read the Vernier Proceed thus until a graduation on the vernier is found exactly in line with another on the limb, and the first row of figures on the vernier will give the number of minutes passed over. When the vernier is moved more than fifteen minutes to either side, the number of additional minutes, up to thirty or one half degree of the limb, is given by the second row of figures on the opposite side of the vernier. To read beyond thirty, add the minutes given by the vernier to that number, and the sum will be the correct reading.

In all cases where the zero point of the vernier passes a whole degree of the limb, this must be added to the minutes, in order to ascertain the distance over which the vernier has been moved.

It is well known that the magnetic needle deviates more or less to the east or west of a true meridian, **Magnetic Declination** or north and south line. This deviation, which is called the magnetic declination, is not constant,

but increases or decreases to a very sensible degree in a series of years.

Thus, at Troy, N. Y., a line bearing in 1871, N. 31° E., would in 1910, with the same needle, have a bearing of about N. $33^{\circ} 20'$ E., the needle having in that interval traveled nearly $2^{\circ} 20'$ to the west.

For this reason, in running over lines from field notes of some years' standing, the surveyor is obliged to make an allowance, both perplexing and uncertain, in the bearing of every line. It was to obviate this difficulty that the Vernier Compass was devised.

It will be seen that the surveyor having the Vernier Com-
To set off the pass can, by moving the vernier to either
Declination side, and with it, of course, the compass
circle attached, set the compass to any declination.

He therefore places his instrument on some well defined line of the old survey, and turns the pinion until the needle of his compass indicates the same bearing as that given in the field notes of the original survey. Then, clamping the vernier, he can run all the other lines from the old field notes without further alteration.

The reading of the vernier on the limb in such a case would show the change of declination of the two different periods.

The magnetic declination at any place being known, a true meridian, or north and south line, may be run by moving the vernier to either side, as the declination is east or west, until the arc passed over on the limb is equal to the angle of declination, and then turning the compass until the needle is made to cut the zeros on the graduated circle. The line of sights will then give the direction of the true meridian of the place.

Such a change in the position of the vernier is necessary in surveying the United States public lands, which surveys are always run from the true meridian.

The line of no declination, or the line upon which the needle will indicate a true north and south direction, is situated in the United States nearly in an imaginary line drawn from Sault Ste. Marie, Michigan, to Charleston, South Carolina. A magnetic needle placed east of this line has a declination to the west, and when placed west of the line the declination is to the east; and in both cases it increases as the needle is carried farther from the line of no declination.

Thus, in Minnesota, the declination is from eight to eleven degrees to the east, while in Maine it is from fifteen to nineteen degrees to the west. At Troy, in the year 1912, the declination is about $11^{\circ} 41'$ to the west, and is increasing now in the same direction about three minutes annually.

The magnetic declination does not remain constant through an entire day, but reaches its farthest point east about 8 o'clock A. M., and its farthest point west about 2 o'clock P. M. The cause of this daily variation of the needle is not understood, as observations show that it is greater in summer than in winter.

Conditions of temperature, magnetic storms and other causes at times affect the needle. Our own experiments show that different needles observed at the same time and under the same conditions differ in their direction, but show nearly the same daily change.

A less important use of the vernier is to give a reading of the needle to single minutes, which is obtained as follows: First be sure, as in all observations, that the zero of the vernier exactly corresponds

with that of the limb. Then, noting the number of whole degrees given by the needle, move back the compass circle with the pinion until the nearest whole degree mark is made to coincide with the point of the needle, read the vernier as before described, and this reading added to the whole degrees will give the bearing to minutes.

TO ADJUST THE COMPASS

To adjust the levels: Bring the level bubbles into the middle by the pressure of the hand on different parts of the plate, and turn the compass half way around.

Levels Should the bubbles run to the end of the tubes, it would indicate that those ends were the highest. Lower them by loosening the screws under the lowest ends and tightening those under the highest ends until, by estimation, the error is half removed. Level the plate again, and repeat the first operation until the bubbles will remain in the middle during an entire revolution of the compass.

The sights may next be tested by observing through the slits a hair or thread, made exactly vertical by a plummet.

Sight Vanes Should the hair appear on the side of the slit, the sight must be adjusted by filing its under surface on the side which seems the highest.

Needle To adjust the needle: Having the eye nearly in the same plane with the graduated rim of the compass circle, with a splinter of wood or an iron wire bring one end of the needle in line with any prominent graduation of the circle, as the zero or the ninety degree mark, and notice if the other end corresponds with the degree on the opposite side. If it does not, bend the center pin, by using the small brass wrench furnished with our compasses, about one eighth of an inch below the point of the pin, until the

ends of the needle are brought into line with the opposite degrees.

Then, holding the needle in the same position, turn the compass half way around, and note whether it now cuts opposite degrees. If not, correct half the error by bending the needle, and the remainder by bending the center pin. The operation should be repeated until perfect reversion is secured in the first position.

This being obtained, it may be tried on another quarter of the circle. If any error is there manifested, the correction must be made in the center pin only, the needle having been already straightened by the previous operation.

When again made to cut, it should be tried on the other quarters of the circle, and corrections made in the same manner until the error is entirely removed, and the needle will reverse in every point of the graduated surface.

TO USE THE COMPASS

In using the compass, the surveyor should keep the south end toward his person, and read the bearings from the north end of the needle. He will observe that the E and W letters on the face of the compass are reversed from their natural position, in order that the direction of the line of sight may be correctly read.

The compass circle being graduated to half degrees, a little practice will enable the surveyor to read the bearings to quarter degrees or even less, estimating with his eye the space bisected by the point of the needle; and as this is as close as the traverse table is usually calculated, it is the general practice.

Having leveled the compass, bring the south end toward the person, place the eye at the little button, or eyepiece, on

the right side of the south sight, and with the hand hold a card on the front surface of the north sight, so that its top edge will be at right angles with the graduated edge and coincide with the zero mark. Then, sighting over the top of the card, note upon a flagstaff, held near the compass, the height cut by the line of sight, move the staff up the elevation and carry the card along the sight until the line of sight again cuts the same height on the staff. Read off the degrees and half degrees passed over by the card, and this will be the angle required.

Angles of Depression Proceed in the same manner, using the eyepiece and graduations on the opposite side of the sight, and reading from the top of the sight.

New and Old Surveys When the compass is to be used in making new surveys, the vernier should be set at zero and clamped.

In surveying old lines, the change of the magnetic declination should be ascertained by setting the compass on some well defined line of the tract, and making the bearing agree with that of the old survey, by moving the circle as already described. The circle can then be clamped, and the old lines retraced from the bearings given by the original surveyor.

When the magnetic declination is known, it can be set off by the vernier, and the compass used to run a true meridian by the needle.

Caution should be exercised, in handling the compass, that the glass face does not become charged with electricity excited by the friction of cloth, silk, or the hand, so as to attract the needle to its under surface.

Electricity Should the glass become so charged, however, the electricity may be removed by breathing upon it, or by touching different parts of its surface with the moistened finger. Ignorance of

this apparently trifling matter has caused the inexperienced surveyor much annoyance.

REPAIRS TO THE COMPASS

To enable the surveyor to make such repairs as are possible without recourse to an instrument maker, we add a few simple directions.

The magnetic needle is the most vexatious and troublesome part of a surveyor's instrument, and its imperfect working is almost invariably due to a roughened or scratched jewel or to a dulled center pin, or to both, and rarely to loss of magnetism.

A wire is coiled on the south end of the needle, and may be moved back or forth to counterbalance the varying magnetic attraction at the north end, as a needle which is perfectly balanced in one locality is frequently out of balance in a different latitude.

It may sometimes happen that the needle has lost its polarity and must be remagnetized. To do this, proceed as follows: Unscrew the bezel ring that holds the glass face, and remove the needle. Pass each end of the needle from middle to extremity with a gentle pressure over the magnetic pole of a permanent magnet, describing before each pass a circle of about six inches radius, to which the surface of the pole is tangent, drawing the needle toward the body, and taking care that the north and the south ends are applied to the opposite poles of the magnet.

Should the needle be returned in a path near the magnetic pole, the current induced by the contact of the needle with the magnet, in the pass just described, would be reversed, and the magnetic virtue almost entirely neutralized at each operation. When the needle has been passed in this

manner about twenty five times in succession, it will be fully charged.

The center pin should occasionally be examined, and, if much dulled, should be taken out with the brass wrench or
Center Pin with a pair of pliers, and sharpened on a hard oilstone, the operator placing it in the end of a small stem of wood, or in a pin vise, and delicately twirling it with the fingers as he moves it back and forth at an angle of about thirty degrees with the surface of the stone.

When the point is made so fine and sharp as to be invisible to the eye, it should be smoothed by rubbing it on the surface of a soft and clean piece of leather.

All needle instruments made by us have now a thick selected glass protecting the compass face.

The glass is accurately fitted to the bezel ring and is cemented in place rendering it watertight.

In case the glass is broken, which rarely happens, we advise the removal of the bezel ring and the sending of it to us for the proper insertion of a new glass.

To replace a level vial: Take out the screws which hold the level tube to the plate, pull off the brass ends
Level Vial of the tube, and with a knife blade scrape out the plaster from the tube. Then with a stick a little smaller than the diameter of the tube, with its end hollowed out so that it will bear only on the broad surface of the level vial, push out the old vial and replace it with a new one, taking care that the crowning side, which has a file mark on the end of the vial, is placed on the upper side.

When the vial does not fit the tube, it must be wedged by putting slips of paper under it, until it moves in snugly.

After the vial is in its place, put around its end plaster of paris mixed with water to the consistency of putty, taking care not to cover the tip of the glass, and slip on the brass ends. Melted beeswax dropped upon the ends of the vial is quite as effective as the plaster of paris, and often more easily obtained.



No. 232

PLAIN COMPASS

THE Plain Compass shown in the illustration has a six inch needle, and is furnished with levels, sight vanes, socket, etc.

The compass box is in the same piece with the main plate, and the instrument is used chiefly in the surveys of new lines, or in the preparation of maps, where the magnetic declination is not required.

We make three sizes of this instrument, having needles respectively four, five, and six inches long, and differing also in the length of the main plate, which, in the four inch compass is twelve and one half inches long, and in the larger sizes fifteen and fifteen and one half inches. The average weights of the different sizes, with the

brass mountings of the staff, are respectively six, seven and three quarters, and nine and one half pounds.

The adjustments and use of the Plain Compass are substantially the same as those of the Vernier Compass just described.

Compound Ball Spindle We manufacture a compound ball spindle, which has a tangent movement, and which gives all the perfection of more costly arrangements at a very moderate expense.



Nos. 240 and 241

COMPOUND BALL SPINDLE AND LEVELING ADOPTER

As shown in the illustration, No. 240, it has an interior spindle, around which an outside hollow cylinder is moved by turning the double headed tangent, which has in the middle a screw working into teeth cut spirally around the cylinder. The compass or other instrument revolves on the outside socket, exactly as if placed on a common ball spindle; but when a slower movement is desired, it can be clamped and turned

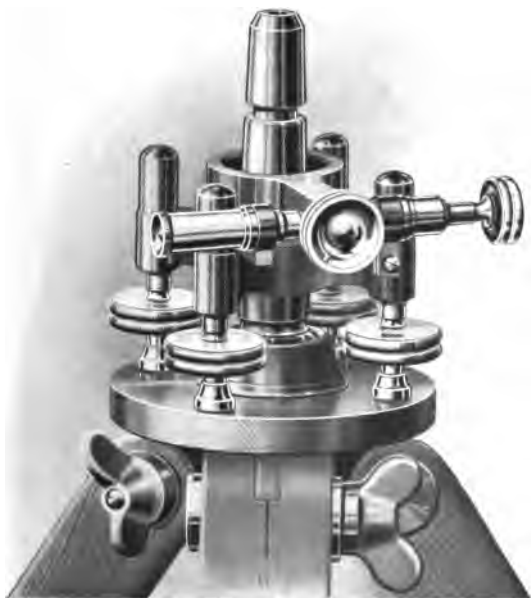

Nos. 176 and 242
LEVELING HEAD

gradually around the interior spindle by the tangent screw, until the slit of the sight or the intersection of the wires is brought accurately upon the point observed.

When the compound ball spindle is ordered with a compass, we omit the plain ball spindle and make a reduction of \$2.00 from the price of the instrument.

Leveling For more convenient leveling of the com-
Adopter pass, as well as other instruments, we make the leveling adopter shown, No. 241, page 162, which is screwed to the top of the tripod like the leveling head. It can be used either with a simple ball spindle, or with the compound ball with tangent screw, as shown in the illustration.

The instrument is made approximately level upon the ball, and finally made truly horizontal by the leveling screws.

We also make for use with surveyors compasses and vernier transit compasses a leveling head, consisting of up-
Leveling per and lower plates, four leveling screws,
Head and clamp and tangent movement. See Nos. 176 and 242, page 163.

This leveling head furnishes a stable support for the instrument, and affords the same conveniences for leveling and accurate adjustment in azimuth as the leveling heads on the more expensive instruments.

TELESCOPIC SIGHT

WE have for years furnished a telescope which can be attached to the sight vanes of compasses, and easily removed, and many hundreds of these attachments are now in use in all parts of the country.



No. 261
TELESCOPIC SIGHT

This telescope is fitted with cross wires, and is attached to a movable band which, as shown in the illustration, can be slipped over the sight of a compass, clamped at any point desired, and adjusted with a screw driver and a steel adjusting pin.

To put this attachment in place, slip the band over the south sight of the compass, having the telescope at the right hand and the clamp screw on the outer surface of the sight, placing the band as low as will allow the telescope to revolve without striking the compass. This place should be marked by a line across the sight, or by a screw or pin on the inner surface of the sight, that the band may be set at the same point in subsequent use.

To fasten the band to the sight, bring up the clamp screw with a pressure just sufficient to hold the band to its place, tighten the screw on the left until the band is against the right edge of the sight, and finally tighten the clamp screw.

To focus the telescope, turn the end of the eyepiece until by the spiral motion of the tube the cross wires are brought into distinct view. The objective is then moved in either direction by the pinion on the side of the telescope, until the object is clearly seen.

The optical axis of the telescopic sight is at one side of the line of sight of the sight vanes, but parallel with it. The difference between a sight taken with the sight vanes and one taken with the telescope is, at a distance of two hundred feet, about two minutes; so small that it may be disregarded in any survey made with the magnetic needle. If all the lines are run with the telescopic sight, the angles measured will be accurate, as even this slight difference is entirely eliminated.

When desired, the telescopic sight may be mounted upon an offset standard with counterpoise, and so arranged that the line of sight is in line with the zeros of the compass circle. When in use this standard, with the telescope attached, is substituted for the south sight of the compass.

When furnished with a new instrument the telescope is packed in the box with the compass, but it can be safely sent



No. 262

TELESCOPIC SIGHT

by mail to any part of the country, packed in a case in which it may be kept when not in use.

Sizes and Power We make two styles of the telescopic sight, Nos. 261 and 262. The telescopes are about nine inches long and have a power of eighteen to twenty diameters. No. 262 is furnished with stadia wires, in addition to the plain cross wires used in the other telescope.

The attachments of vertical circle, three inches in diameter and reading to five minutes, level on telescope with graduated vial, and clamp and tangent to axis, **Extra Attachments** may be used with either of these telescopic sights. Whenever the level is used, it is necessary that the clamp and tangent to axis be added.

In the illustration on page 167, the telescope No. 262 is shown fitted with a vertical circle, a level, and clamp and tangent. For simple sighting the level and circle can, of course, be dispensed with, but in the use of the stadia the tangent movement is desirable.

When measurements are to be recorded in chains and links, the stadia wires should be made to cover one foot at a distance of sixty six feet; if recorded in feet, the wires should cover one foot at a distance of one hundred feet.

The rod used with the stadia should be graduated to feet and decimals of a foot, and provided with two targets, one being fixed at some definite point, while the other can be moved as the surveyor requires, the distance between the two targets being accurately read off by the vernier of the movable one. A self reading rod, as described on pages 238-240, may be used without target for short distances.

In using the stadia, the upper wire is brought by the tangent screw precisely upon the upper or stationary target, while the lower target is moved up or down until the lower wire exactly bisects its center line, when the rod is read and the distance recorded.

The advantage of the telescope over the sight vanes is readily apparent. Much longer sights can be taken, either
Advantage of the Telescope fore or back, and lines run up and down steep hillsides with the same facility as on level ground, and with more accuracy, and with great relief to the eyes of the surveyor, often severely strained by the use of the sight vanes of the compass. Indeed, it may be said that with this simple attachment every compass can be transformed into a transit compass, and the advantages of the telescope brought within the reach of every surveyor, at small cost.

TO ADJUST THE TELESCOPIC SIGHT

To make the adjustments, and indeed to do any correct work with a compass, the level bubbles should remain in the middle when the instrument is turned upon its spindle, and the sights should trace a vertical line when the compass is level.

The means of effecting the adjustments will be understood by the illustration on page 165 and the outline cut on page 170, the former showing the rear, and the latter the front view of the band to which the telescope is attached.

Telescope Axis To make the telescope axis horizontal, the compass being in good order, first bring the levels into the middle and place the band in position upon the sight, as before described. Focus the telescope, and

set the vertical cross wire on the edge of a building distant from fifty to sixty feet, at a point near the ground. Clamp the compass to the spindle, and raise the telescope to the top of the building. If the wire strikes to the right of the edge, it shows that the right end of the telescope axis is the lowest.

To raise it, loosen the screws, B B, C C, which hold the piece containing the axis of the telescope, and by the screws, D D, the lower of which should be unscrewed and the upper one tightened, raise the telescope until the wire will follow the vertical line.

If the cross wire strikes to the left when the telescope is raised, proceed exactly the reverse in making the correction, until the wire will follow the edge from one

end to the other. If the vertical cross wire is not parallel with the edge, loosen the capstan head screws, and turn the ring by the screw heads until the correction is made; then tighten the screws.

To bring the line of collimation into a position at right angles with the axis of the telescope, so that the cross wires will indicate two points in opposite directions in the same straight line, proceed as directed on pages 38 to 40.

Adjustment of Telescope to the Sights

Find or place two objects, one on each side of the compass and from three hundred to four hundred feet distant from it, which the sight vanes will intersect. Clamp to the spindle and sight through the telescope at either of the objects.

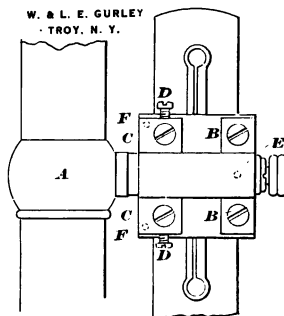

If the vertical wire strikes to the right, loosen the screws B B, and screw up those in front, marked F F, the ends only of which are shown in the figure, until the vertical wire bisects the object, looking again through the vanes to see that the same object is seen through both telescope and sights. If the cross wire should strike to the left of the object, proceed in a manner exactly the reverse until the error is corrected.

This adjustment is always made by us before the attachment leaves our hands, and need not be disturbed except in case of accident or careless interference with the cross wire screws; but it can be easily made by any surveyor in a few moments and with very little practice.

When the adjustments are complete, the attachment can be put in place on the sight, and removed and replaced again, without danger of derangement.

The construction of the telescopic sight does not admit of subsequent addition of the extra attachments of circle level and clamp.

When, therefore, it is desired to add either or all of these attachments to a telescopic sight which has been purchased without them, an exchange is effected and a new telescopic sight supplied with the desired attachments and an allowance made for the actual value of the sight exchanged.

POCKET COMPASSES

WE manufacture a variety of small instruments which are so portable and at the same time so efficient that they are often used, in preference to the larger ones, for preliminary or reconnoissance work.

POCKET SOLAR COMPASS

The Pocket Solar Compass has a needle three inches long and a limb four and one half inches in diameter, graduated to half degrees, figured one row 0 to 180 each way, and reading by one double vernier to single minutes.

The arrangement of the plates is similar to that of the large Solar Compass, the lower plate carrying the sights
Plates and Sights revolving around the upper or compass plate, to which are attached the solar parts, levels, etc. There is a clamp and tangent movement to the horizontal limb and another to the whole instrument about its spindle, both now made with an opposing spring.

The sights are about four and one half inches high, the distance between them being nearly seven inches. They have a slit and hair in half their height, and are hinged to fold down in packing. The compass circle is arranged with a pinion and is movable, so as to set off the magnetic declination to five minutes. The needle has a lifting lever by which it is raised against the glass.

The solar apparatus is attached to the upper plate, and
Solar Parts consists of the usual hour, latitude, and declination arcs, marked respectively A, C, and B in the illustration on page 173, with an arm, F F, to the declination arc, carrying the solar lenses and lines.

Latitude Arc The latitude arc is graduated to half degrees, and reads by vernier to five minutes.



No. 278

POCKET SOLAR COMPASS



Declination Arc The declination arc is graduated to quarter degrees, and reads by vernier to single minutes.

The hour arc is graduated on its inner edge into hours and twelfths, or spaces of five minutes of time, the index on the declination arc above easily enabling one to read single minutes of time. The hour arc is made movable upon its supporting segment to either side,

Hour Arc its outer edge being also graduated on the middle portion to spaces of five minutes of time, and read by a vernier upon the segment to single minutes. In this way the equation of time for any given day is set off at once, and the time indicated by the index of the hour arc made to agree with mean time, or that given by the clock.

The solar lenses and lines are placed as in the larger instruments, the declination arc being also reversible as the sun changes from north to south of the equator.

When packed in the case, the declination arc with its arm is detached from the hour arc, and this, together with the latitude arc, folds close to the compass box.

The Pocket Solar Compass is used either upon a ball spindle with staff mountings, or as shown, upon a light tripod like the other pocket compasses, and often with a small leveling head, with clamp and tangent screws.

Sometimes a side telescope with counterpoise is used in addition to the sight vanes.

The adjustments and use of the Pocket Solar Compass are substantially the same as those of the large Solar Compass already described, and its indications are so accurate that it will give the true meridian within an error of one minute. This fact, taken in connection with the deflection of the magnetic needle, will indicate



No. 285
POCKET RAILROAD COMPASS
[Page 175]





with certainty the presence and direction of veins of magnetic iron ore.

This instrument is very nearly as accurate as the large Solar Compass, while it is much more portable. It weighs, without box or tripod, four and three quarters pounds.

POCKET RAILROAD COMPASS

The instrument shown is a one vernier Railroad Compass in miniature. The limb is five inches in diameter, graduated to half degrees, figured one row 0 to 180 each way, and reads by vernier to single minutes. The needle is three and one half inches long, and the magnetic declination can be set off to single minutes.

This instrument has the improved spring tangent, and the vernier is placed at an angle of thirty degrees with the line of sight. The sights fold down closely for convenience in packing, and are each made half slit and half hair, so that fore and back sights may be taken without turning the instrument.

The Pocket Railroad Compass can be used for a great variety of work, and, with light extension tripod, is especially adapted for surveys of mines, where angles must be taken independently of the needle.

POCKET RAILROAD COMPASS WITH TELESCOPE

In the illustration of No. 293 is shown a form of the Pocket Railroad Compass with telescopic sight.

The plates are circular and the sights are made half slit and half hair, and are hinged to fold down close to the glass.

The needle is four and one half inches long, and there is an arc with vernier, on the outside of the compass plate, for setting off the magnetic declination.

The instrument has a limb four inches in diameter, figured 0-180, placed inside the compass circle, and reading by a vernier to single minutes. The spindle has a clamp and tangent movement.

The sights being inclined to each other, as shown, a short standard is secured by two milled head screws to the tops of the sights, and a telescope is thus placed in position, making the instrument in effect a very light surveyors transit.

The attachments of vertical circle, level, and clamp and tangent, as shown in the illustration, may also be added, furnishing the means for taking grades and running levels with accuracy sufficient for the common practice of the surveyor.

The sights are placed at one side of the line of zeros, and the telescope is thus brought into that line and over the center of the instrument. The short standard can be detached with the telescope and placed in the case, or easily replaced without deranging the adjustments.

The Pocket Railroad Compass may be used either on a staff or with small tripod, and, if desired, with leveling adopter, as shown.

The weights of the Pocket Railroad Compasses, including the brass mountings of the staff, but without tripod, are as follows:

No. 285, 3½ inch Compass, about	4 lbs.
No. 288, 4½ inch Compass, about	4½ "
Nos. 291 and 292, 4½ inch Compass, about	6½ "
No. 293, 4½ inch Compass, about	7¾ "

an
et-
ed
er-
nt
ort
ps
n.
ors
nd
d.
ls
he
nd
er
th
at
a
ig
ig
is



No. 293
POCKET RAILROAD COMPASS
[Page 179]





POCKET VERNIER COMPASS



Nos. 300 and 305

The Pocket Vernier Compass is an excellent and portable instrument for preliminary work, having a fine needle and a vernier and clamping nut, by which the sights can be placed at an angle with the line of zeros, so as to set off the magnetic declination as with the Vernier Compass.

The instrument has folding sights, two levels and staff mountings, and is packed in a mahogany case.

We make two sizes of the Pocket Vernier Compass, having needles respectively three and one half and four and one half inches long. In the smaller instrument the sights have a slit in the south vane and a hair in the north vane, for readily finding an object; but in the larger size the sights are made

half slit and half hair, as shown on page 181. Both sizes have the compass circle graduated to half degrees. In the smaller size the vernier of the variation arc reads to five minutes, and in the larger size to single minutes. The instrument may be used upon a light tripod, if desired.

When ordered, a rack movement with pinion is added, by which the magnetic declination may be set off more readily

The compass with three and one half inch needle weighs about one and three quarters pounds; that with four and one half inch needle about two and three quarters pounds.

POCKET VERNIER COMPASS WITH TELESCOPE

As shown on page 183, a telescope with attached vertical circle, level, and clamp and tangent may be added to the sights of the four and one half inch Pocket Vernier Compass, making this little instrument practically a transit compass for land surveying and reconnoissance, capable of running levels and grades with accuracy sufficient for ordinary practice. The sights in this instrument are placed at one side, that the telescope may be directly over the center, and the instrument should have a clamp and tangent movement to the spindle, as shown in the figure. When packed for transportation, the telescope and support are detached from the sights and packed separately in the case. Staff mountings are always furnished with these compasses, and a light tripod, as shown, is very generally added.

The weight of compass No. 312, without tripod, is about four and one half pounds, and the tripod weighs about four pounds.



No. 312
POCKET VERNIER COMPASS
[Page 183]

POCKET PLAIN COMPASS

Besides the Pocket Vernier Compass, we make a similar instrument without a vernier, which is often found serviceable. The Pocket Plain Compasses have needles two and one half and three and one half inches long, and are supplied with levels and staff mountings or not, as desired. They are packed in a light mahogany case, the sights folding down close to the glass.



Nos. 316 and 318

A convenient arrangement is shown in No. 327, at *a*, for use with Pocket Compasses Nos. 275 to 319, affording in **Leveling Adopter** connection with the ball a rapid and accurate means of leveling any of the smaller instruments. The attachment weighs less than one pound, and can be placed on the tripod by merely removing the brass cap. Its value and use are readily apparent.

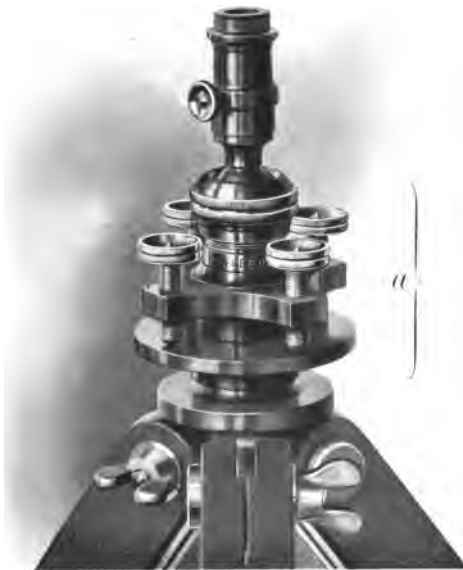

No. 327

GEOLOGISTS COMPASS
FOREST SERVICE STANDARD



No. 335

This instrument has proven admirably adapted for topographical work, and has been adopted by the U. S. Forest Service for the use of field men in making forest surveys and maps.

It is made of aluminum to secure lightness in weight and has a needle two and five eighths inches long enclosed with its compass circle in a circular box set on a plate four inches square.

The edges of this base are beveled and graduated two for a tangent scale and two to inch scales. One of these latter is graduated to eighths, each of which represents ten chains, and the other is decimal. The compass circle is made movable, and by a vernier attached to it on the inside the magnetic declination may be set off to five minutes.

On the under side of the plate is a township plat.

On the south side of the compass face is an arc of 180 degrees, figured on each side of the 0 line from 0 to 90. A weighted pendulum hung from the center pin indicates, by its pointer on this arc, the angle of slope, when the compass is placed so that it rests on its south edge. On the outside of the box containing the compass circle is a movable circle, beveled and graduated on its upper edge and figured from 0 to 90, and having at each quadrant a slit for sighting.

Two tall folding sights are attached to the edge of the circular box, and two small levels are placed at right angles with each other upon the base.

The compass is supported on a simple ball spindle and socket, with staff mountings, and is usually carried in a leather pouch with shoulder and belt straps.

CLINOMETER COMPASS

Another form of Pocket Compass is shown on page 188. It is made of brass, and is known as the Climometer Compass. It has a needle three and one half inches long, enclosed with its compass circle in a circular box set upon a base four and one half inches square. On one edge of this base is placed the rectangular side upon which the Compass may be set in determining grades.



No. 338

CLINOMETER COMPASS

The small pendulum swinging from the center pin designates, by its index, the degree of slope upon the graduated arc on the compass face. Two folding sights are attached to the circular box, and two small levels are placed at right angles with each other upon the base. The Compass is supported upon a simple ball spindle and socket, with staff mountings, and is packed in a mahogany box.

MINERS OR DIP COMPASS

The Dip compasses, two forms of which are shown on this page, consist essentially of a magnetic needle so suspended as to move readily in a vertical direction, the angle of inclination, or dip, being measured upon the graduated rim of the compass circle.



Nos. 340 and 341

Nos. 344 and 345

When in use, the ring or bail is held by the hand, and the compass box by its own weight assumes a vertical position. It must be held in the plane of the magnetic meridian.

In this position the needle, when unaffected by the attraction of iron, assumes a horizontal line, as shown by the zeros of the circle. When brought over any mass of magnetic iron ore it dips, and thus detects the presence of such ore with certainty.

If the Miners Compass, Nos. 340 or 341, is held horizontal, it serves as an ordinary pocket compass, and indicates the magnetic meridian, in the plane of which it should be held when used to ascertain the dip.

Several forms of this instrument are made. Those shown as Nos. 340 and 341, with a three inch needle, have the two sides of glass, and are provided with a stop for the needle, which is moved by the little brass knob between the ends of the ring.

The Norwegian Compass, Nos. 344 and 345, is a modification of an instrument used in northern Europe.

It has a needle either three or four inches long, resting upon a single vertical pivot so as to move freely in a horizontal direction. At the same time, being attached to the needle cap by two delicate pivots, one on each side, it is free to dip like the needle of the ordinary Miners Compass.

In use carefully note the following:

The needle of our Miners or Dip Needle Compass is adjusted to read 0 at Troy, N. Y., when held in the plane of the magnetic meridian, but it may read differently in another place.

The readings of these compass needles are always relative and not absolute; therefore, if a needle is held in the plane of the meridian, in a place where it is known that there

is no magnetic attraction, and the reading is carefully noted; and the needle is then held in the plane of the meridian where magnetic attraction is suspected, a different reading will show the presence of some magnetic body, whether the needle is, in the first case, perfectly horizontal (reads to zero) or not.

When in use, the needle should always be held so that it will swing freely in the plane of the meridian, the stops being drawn entirely out of the way.

When not in use, the stops must be pushed entirely in, so that the delicate bearings will not be injured.

There is no instrument made which will indicate the presence of gold or silver.

BRASS DIAL COMPASS

This instrument has a needle two and five eighths inches long, and with its compass circle is enclosed in a circular box set upon a base four inches square, three edges of which are chamfered and graduated, the one on the W side of the compass into inches and tenths and the two others into degrees and half degrees, and figured from a center on the southwest corner of the base.

The compass circle is movable, in order to set off the magnetic declination, and has a vernier attached to it on the inside, by which a graduated arc on the face of the compass is read to five minutes.

There is also on the south side of the face an arc of one hundred and eighty degrees, figured from 0 to 90 on each side of the south or zero line of the face.

A pendulum with index point hung from the center pin reads this arc when the compass is set up vertical on the raised south edge, thus making it a clinometer or slope measure.

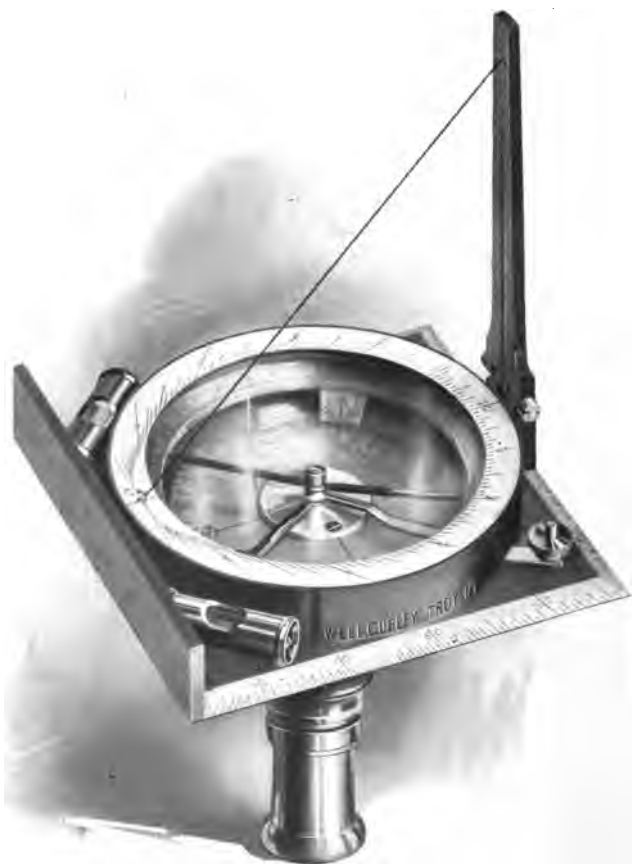

No. 348
BRASS DIAL COMPASS

The sight is hinged to fold in packing, but when erect it makes taut a silk thread, attached at one end to the sight and at the other to an hour circle above the compass glass, at an angle with the plane of the hour circle equal to that of the latitude of the place where the compass is used. The hour circle is graduated for any required latitude, as a sun dial, the thread serving as a gnomon to give apparent time with the sun.

The Dial Compass is extensively used in this country in regions where there is local attraction, and it is desirable to have a simple means of determining the meridian independently of the needle.

This can be easily and quickly done by turning the compass, with dial graduated for the latitude of the place, until the shadow of the thread when the compass is held level indicates local time on the dial. The line of zeros will then be in the meridian. The needle may be set to the meridian by laying off the magnetic declination and any deflection of the needle from the true meridian will indicate the presence of veins of magnetic iron ore.

Extra hour circles, graduated for any latitude and to fit the same compass, can be furnished, and we also supply staff mountings, including ball spindle and socket, when desired.

ALUMINUM DIAL COMPASS

The illustration (see page 194) shows an improved form of the Dial Compass, made of aluminum, and differing from our No. 348 in several respects. This instrument is of the same size and has the same parts as the Dial Compass shown on page 192, and has in addition a movable circle graduated on its beveled edge from 0 to 90 degrees. At each quadrant there is a slit for sighting, and an open sight is furnished with the

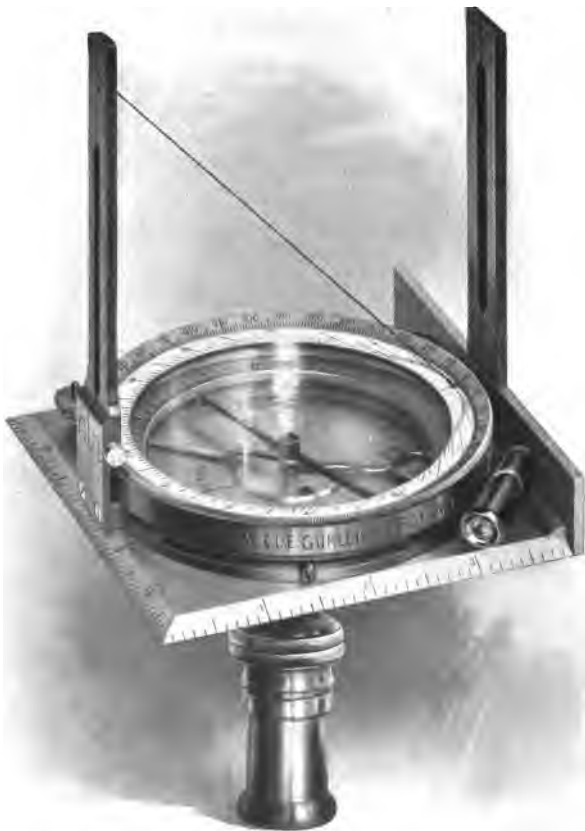

No. 350

ALUMINUM DIAL COMPASS

compass, to be placed upon the clinometer base when desired, and used in connection with the regular sight. The instrument is mounted upon a small ball spindle and socket, with staff mountings, and is packed in a mahogany box.

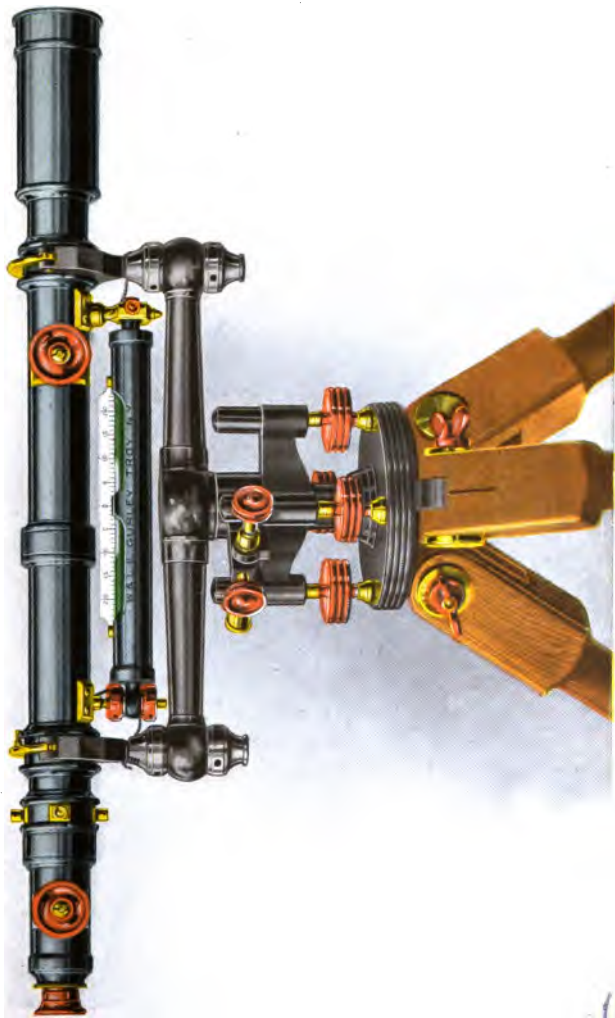

No. 376
20 INCH Y LEVEL
[Page 195]





ENGINEERS Y LEVELS

OF the different varieties of leveling instruments, the Y Level is universally preferred by American engineers, on account of its easy adjustment and accuracy.

We manufacture five sizes of Y Levels, having telescopes twenty two, twenty, eighteen, fifteen, and twelve inches in length. The illustration of No. 376 shows our twenty inch Level.

The telescope has near its ends two rings of bell metal, turned truly and of precisely the same diameter. On these rings it rotates in the Ys, or it can be clamped, when the clips of the Ys are brought down upon the rings, by pushing in the tapering pins.

The telescope has a rack and pinion movement to both objective and eyepiece, and an adjustment for centering the eyepiece, shown at A A in the sectional view on page 198. The arrangement for insuring the accurate projection of the objective slide is also shown at C, in the same cut. Both of these are concealed from observation and disturbance by thin bands which screw over them.

The objective slides on the eighteen, twenty, and twenty two inch Y levels are now fitted with our improved dust guard, which is secured to the main telescope and remains stationary while the slide is moved in or out, thus fully protecting it against injury from any outside cause.

Short Focus The telescopes of our Y Levels, like those of our transits, are now arranged so that they may be focused upon an object much nearer the instrument than formerly.

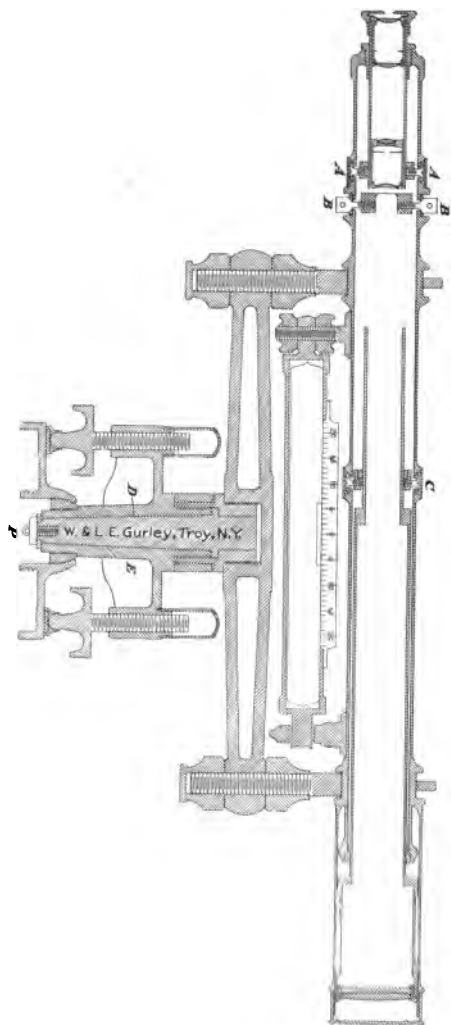

SECTIONAL VIEW OF Y LEVEL

This improvement will often be of decided advantage to the engineer. Care, however, should be taken by the observer using the instrument at short distances to correct the level vial if it is slightly out of adjustment when the instrument is thrown out of balance by the projection of the slide.

Compass A small compass, for obtaining the bearings of lines, with three inch needle, but without sights, is sometimes attached to the telescope in such a manner as to be readily removable when desired.

Horizontal Circle A horizontal circle three and one half inches in diameter can be fitted to the leveling head of the Y Level. The circle is graduated to degrees, and is read by vernier to five minutes.

The interior construction of the telescope will be understood from the sectional cut on page 198, which shows the **Objective Slide** adjustment which insures the accurate projection of the objective slide. This is peculiar to our instruments, and is always made so perfectly that it needs no attention from the engineer.

The necessity for such an adjustment will appear when we state that it is almost impossible to make a telescope tube a perfect cylinder on its inner surface. It is evident, therefore, that the objective slide which is fitted to this surface, and moves in it, must partake of its irregularity, so that the objective and the line of collimation dependent upon it, though adjusted in one position of the slide, will be thrown out when the slide is moved out or in.

To prove this, let any level be selected which is constructed in the usual manner, and the line of collimation adjustment be made upon an object as near as the range of the slide will allow. Then let another object be selected as distant as may be clearly seen; upon this rotate the wires, and

they will generally be found out of adjustment, sometimes to a degree fatal to any confidence in the accuracy of the instrument. The arrangement adopted by us to correct this imperfection, and which perfectly accomplishes its purpose, is shown in the sectional cut.

Here are seen the two bearings of the objective slide, one being in the narrow ring slightly less in diameter than the main tube, the other in the adjustable ring shown at C, suspended in the middle of the telescope by four screws.

Advantage is here taken of the fact that the rays of light are converged by the objective, so that none are obstructed by the contraction of the slide except those which diverge, and which ought always to be intercepted and absorbed in the blackened surface of the interior of the slide.

In such a telescope the perfection of movement of the slide depends entirely upon its exterior surfaces at the point of the two bearings. These surfaces are accurately turned, concentric and parallel with each other, and, being fitted to the rings, it is only necessary to adjust the position of the smaller ring so that its center will be coincident with the optical axis of the objective. When this has been done no further correction will be necessary, unless the telescope should be severely injured. The manner in which the adjustment of the objective slide is effected will be considered when we speak of the other adjustments.

As seen in the cut, the telescopes of the eighteen, Rack and twenty, and twenty two inch Levels are furnished with rack and pinion movement to both objective and eyepiece.

The advantages of an eyepiece pinion are that the eyepiece can be moved without danger of disturbing the telescope, and that the wires are brought more certainly into

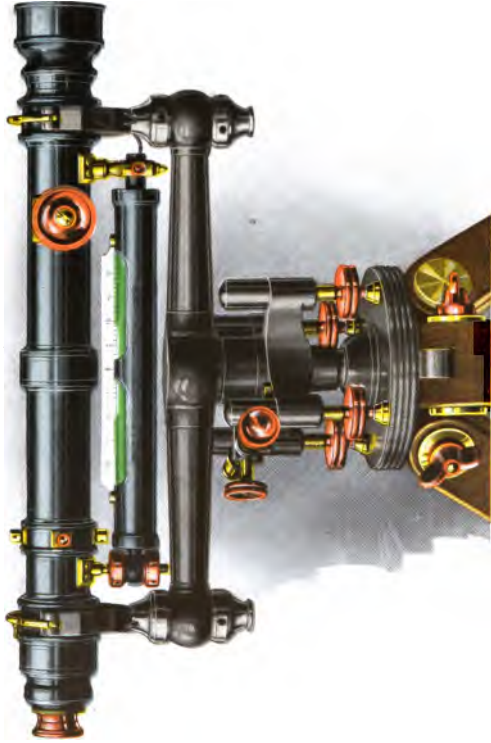

No. 378
15 INCH Y LEVEL
[Page 201]





Vertical line of text or markings on the right edge of the page.



distinct view, so as to avoid any error of observation arising from instrumental parallax.

The level tube, with ground vial and scale, is attached to the under side of the telescope, and furnished at different ends with the usual movements in both horizontal and vertical directions.

The aperture of the tube, through which the glass vial is seen, is about five and one quarter inches long, and is crossed at the middle by a rib or bridge which greatly strengthens the tube.

The level vial is a glass tube with an even bore from end to end, and finely ground on its inner surface, so that the run of the air bubble may be uniform throughout its whole range. The level scale, which extends over the whole length and is set close to the glass, is graduated to tenths of an inch and figured in each direction at every fifth division, from 0 at the middle of the bridge.

The sensitiveness of a ground level is best determined by an instrument called a level tester, consisting of a bar with two Ys to hold the level tube, and pivoted at one end, while at the other end is a micrometer wheel attached to the top of a fine threaded screw which raises the end of the tester very gradually. The number of divisions passed over on the perimeter of the wheel, in carrying the bubble over a tenth of an inch on the scale, is the index of the delicacy of the level. In the tester which we use, a movement of ten divisions of the wheel to one of the scale indicates the degree of delicacy generally preferred for railroad engineering. For canal work a more sensitive bubble is often required, as, for instance, one of five to seven divisions of the wheel to one of the scale.

The Ys of our levels are large and strong, of the best bell

metal, and each has two nuts adjustable with the steel pin.

Ys The clips are brought down on the rings of the telescope tube by the Y pins, which are tapering so as to clamp the rings firmly. The clip of one of the Ys has a pin projecting from it, which, entering a recess in the edge of the ring, insures the horizontal position of the cross wire.

The level bar is round, of the best bell metal, and shaped for greatest strength in the parts most liable to sudden strains. Connected with the level bar is the head of the leveling socket. The instrument is supported on a steel spindle which is fitted in a socket extending entirely through the leveling head.

Projecting from the socket are four arms heavily ribbed and tapped at the end to receive the leveling screws. The leveling screws are so threaded that they fit the long nuts accurately, securing the maximum of wear, and have cups protecting the threads from dust.

Attached to the end of the leveling socket by a hemispherical nut is the bottom plate of the leveling head which is so spaced with reference to the leveling socket that it pivots easily upon it with the movement of the leveling screws.

The length of the steel spindle and the wide spacing of the leveling screws secure stability and delicacy of adjustment for the most accurate work.

The leveling head has the same plates and leveling screws as described in the account of the transit **Leveling Head** (see page 33). The tangent screw has also an opposing spring, as there described.

For the fifteen inch Level we make a leveling head similar to but somewhat lighter than that used with the larger levels.

TO ADJUST THE LEVEL

The adjustment of the objective slide is peculiar to our instruments, and is always made by us so permanently as to need no attention at the hands of the engineer, unless in case of derangement by accident.

To adjust the objective slide, the maker selects an object as distant as may be distinctly observed, and upon it adjusts the line of collimation, in the manner described on page 206, making the intersection of the wires to rotate without passing either above or below the point or line selected. In this position the slide will be drawn in nearly as far as the telescope tube will allow.

With the pinion head he then moves out the slide until an object, distant about ten or fifteen feet, is brought clearly into view. Again rotating the telescope in the Ys, he observes whether the wires will reverse upon this second object.

Should this be the case, he will assume that, as the line of collimation is in adjustment for these two distances, it will be for all intermediate ones, since the bearings of the slide are supposed to be true and their surfaces parallel with each other.

If, however, either or both wires fail to reverse upon the second point, he must, by estimation, remove half the error by the screws at C (see page 198), at right angles with the wire to be corrected, remembering that, on account of the inverting power of the eyepiece, he must move the slide in the direction which apparently increases the error. When both wires have been thus treated, the line of collimation is adjusted on the near object, and the telescope again brought upon the most distant point. The tube is again rotated, the reversion of the wires upon the object once more tested, and the correction, if necessary, made in the same manner.

He proceeds thus until the wires will reverse upon both objects in succession; the line of collimation will then be in adjustment at these and all intermediate points. By bringing the screw heads to a firm bearing upon the washers beneath them, the adjustable ring will be fastened so as to need no further attention for many years. The thin brass ferrule is then screwed over the outside ring, concealing the screw heads and obviating all danger of their disturbance.

In making this adjustment, it is always best to bring the wires into the center of the field of view by moving the screws A A (see page 198), working in the centering ring of the eye-piece tube.

Should the engineer desire to make the adjustment of the objective slide, it will be necessary to remove the level tube, in order that the screw immediately above its scale may be accessible.

The adjustments which are common to all Y Levels, and with which the engineer should be familiar, are:

To adjust the line of collimation, or, in other words, to bring the cross wires into the longitudinal axis, so that their point of intersection will remain on any given point during an entire rotation of the telescope.

To bring the level bubble parallel with the bearings of the Y rings, or with the longitudinal axis of the telescope.

To adjust the Ys, or to bring the bubble into a position at right angles with the vertical axis of the instrument.

To adjust the line of collimation: Set the tripod firmly, remove the Y pins from the clips so as to allow the telescope

Line of Collimation to turn freely, clamp the instrument to the leveling head, and by the leveling and tangent screws bring either of the wires upon the clearly marked edge

of some object, distant from one hundred to five hundred feet. Then with the hand carefully rotate the telescope half way around, so that the position of the same wire is compared with the object selected.

Should it be found above or below, bring it half way back by the capstan head screws at right angles with it, always remembering the inverting property of the eyepiece; bring the wire again upon the object and repeat the first operation until it will reverse correctly. Proceed in the same manner with the other wire until the adjustment is complete. Should both wires be much out, it will be well to bring both nearly correct before either is entirely adjusted.

When this is effected, unscrew the covering of the eye piece centering screws, shown in the sectional view at A A, page 198, and move each pair in succession with a screw driver until the wires are brought into the center of the field of view. The inverting property of the eyepiece does not affect this operation, and the screws are moved directly.

To test the correctness of the centering, rotate the telescope and observe whether it appears to shift the position of an object. Should any movement be apparent, the centering is not perfectly effected. In all telescopes the line of collimation depends upon the relation of the cross wires and objective, and therefore the movement of the eyepiece does not affect the adjustment of the wires in any respect.

When the centering has once been effected it remains permanent, the cover being screwed on again to protect it from derangement.

To adjust the level bubble: Clamp the instrument over either pair of leveling screws, and bring the bubble into

the middle of the tube. Turn the telescope in the Ys, so as to bring the level tube to one side of the middle of the bar. If the bubble runs to the end, it indicates that the Level Vial vertical plane passing through the middle of the bubble is not parallel with that drawn through the axis of the telescope rings.

To correct the error, bring the bubble, by estimation, half way back by the capstan head screws on each side of the level holder, placed usually at the objective end of the tube. Again, bring the level tube over the middle of the bar and the bubble to the middle, turn the level to either side, and, if necessary, repeat the operation until the bubble will keep its position when the tube is turned half an inch or more to either side of the middle of the bar.

The necessity for this operation arises from the fact that, when the telescope is reversed end for end in the Ys in the other and principal adjustment of the bubble, we are not certain of placing the level tube in the same vertical plane, and therefore it would be almost impossible to effect the adjustment without a lateral correction.

Having now largely removed the initial difficulties, we proceed to make the level tube parallel with the bearings of the Y rings.

To do this, bring the bubble into the middle with the leveling screws, and then, without jarring the instrument, take the telescope out of the Ys and reverse it end for end. Should the bubble run to either end, lower that end, or, what is equivalent, raise the other by turning the adjusting nuts on one end of the level until, by estimation, half the correction is made. Again bring the bubble into the middle by the leveling screws, and repeat the whole operation until the reversion can be made without causing any change in the bubble.

It would be well to test the lateral adjustment and make such correction as may be necessary in that, before the horizontal adjustment is entirely completed.

To adjust the Ys: Having made the previous adjustments, it remains to bring the level into position at right angles with the vertical axis, so that the bubble will remain in the middle during an entire revolution of the instrument.

To do this, bring the level tube directly over the middle of the bar and clamp the telescope in the Ys, placing it as before, over two of the leveling screws. Unclamp the socket, center the bubble, and turn the instrument half way around, so that the level bar may occupy the reverse position in respect to the leveling screws beneath.

Should the bubble run to either end, bring it half way back by the Y nuts on either end of the bar. Place the telescope over the other pair of leveling screws, bring the bubble again into the middle, and proceed as above described, changing to each pair of screws successively until the adjustment is very nearly perfected, when it may be completed over a single pair.

The object of this approximate adjustment is to bring the upper plate of the leveling head into a position as nearly horizontal as possible, in order that no essential error may arise in case the level, when reversed, is not brought opposite its former position. When the level has been thus completely adjusted, if the instrument is properly made and the socket well fitted, the bubble will reverse over each pair of screws in any position.

Should the engineer be unable to make the instrument work correctly the error is probably caused by some injury to the spindle or socket.

In such case the instrument should be sent directly to the maker if possible as the injury may require skilled attention.

The adjustments having been completed, and the instrument being precisely level, the engineer should rotate the telescope in the Ys until the pin on the clip of the Y will enter the little recess in the ring to which it is fitted, and by which the horizontal position of the cross wire is insured.

When the pin is in its place, the horizontal wire may be compared with any level line, and in case it should not be parallel with it, two of the cross wire screws that are at right angles with each other may be loosened and, by the screws outside, the cross wire ring turned until the wire is horizontal. The line of collimation must then be corrected again, and the adjustments of the level will be complete.

TO USE THE LEVEL

When using the instrument, the legs of the tripod must be set firmly in the ground, and the bubble brought over each pair of leveling screws in turn and leveled in each position, any necessary correction being made in the adjustments.

Care should be taken to bring the wires precisely into focus, and the object distinctly into view, so that all errors of parallax may be avoided. In all instances, the wires and object should be brought into view so perfectly that the cross wires will appear to be fastened to the surface, and will remain in that position however the eye is moved.

In running levels it is best, wherever possible, that equal fore and back sights should be taken, to avoid any error arising from the curvature of the earth, and also to correct any errors of adjustment in the instrument.

If there is any roughness in the movement of the objective slide, it may be looked for in three places:

1. Remove the four screws that attach the pinion strap to the telescope. See that the pinion turns freely in its socket; if it does not, there is dirt in the bearing which is cutting its surface. Remove the nut at the end of the pinion rod and knock the pinion out of its head with a block of wood. The scratched surface can be rubbed smooth with the back of a knife blade. Put a little tallow on the bearings and replace the parts.

2. While the pinion is out, see that the slide moves freely in or out. If it scratches, rub it smooth.

3. If the pinion movement and slide are found in good order, the roughness may be on the slide of the slot opposite the rack, on the edge which bears upon the back of the pinion socket. Rub this smooth and apply a little tallow.

We now use in the objective slides of all our telescopes, as well as in the pinion sockets, an anti-friction bearing which, after a trial of several years, has proved to be a complete preventive of the abrasion or fretting of the surfaces above mentioned.

- The fifteen inch Level, as shown, has the same arrangement of sockets, tripod, etc., as the larger levels, but has no pinion movement to the eyepiece. The shade to the objective is removable. The leveling head remains attached to the spindle, and is packed with it in the box. The instrument is somewhat smaller and lighter than the other sizes.

Sizes and Weights The average weights of the different sizes of our Y Levels, exclusive of the tripod, are about as follows:

22 inch telescope, with leveling head	14 $\frac{1}{4}$ lbs.
20 inch " " " 	13 $\frac{1}{2}$ lbs.
18 inch " " " 	13 $\frac{1}{4}$ lbs.
15 inch " " " 	11 $\frac{3}{4}$ lbs.
Architects Level " " 	6 $\frac{1}{2}$ lbs.

ARCHITECTS LEVEL

The illustration, No. 380, represents a level, introduced by us in 1874, which is very largely used by architects, builders, and millwrights, as well as by engineers and surveyors, in the grading of streets, sewers, and drains.

The instrument has a telescope twelve inches in length, furnished with rings and Ys like that of the larger levels and adjusted in the same manner. As now made, the telescope can be focused upon an object only six and one half feet from the center of the instrument.

The leveling head has the screws and clamp to the spindle, but no tangent movement. It has also a horizontal circle three inches in diameter, fitted to the upper end of the socket and turning readily upon it. The circle is graduated to degrees, figured from 0 to 90 each way, and is read to five minutes by a vernier which is fixed to the spindle.

The telescope is directed to any object by hand, the spindle turning readily in its socket; but it can be clamped in any position by the clamp screw shown under the circle.

The instrument is placed either upon a light tripod as shown, or on a small triangular plate called a "trivet," having three sharp steel points by which it is firmly set upon any surface. Both tripod and trivet are furnished with the level.

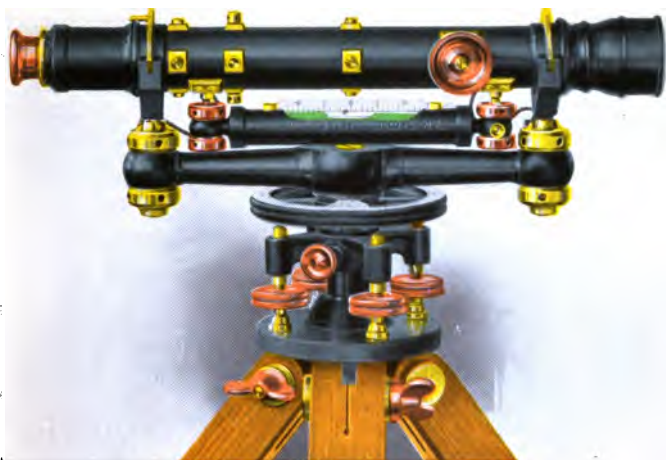

No. 380
ARCHITECTS LEVEL



No. 381
ARCHITECTS LEVEL
[Page 213]



A s
put
sun.
,
and
elan
to t
Adj
of i
and

triv
seo
bul
scr
brc
brc
tel
ope

ey
an
rex

dr
giv
on
wi
ob

A short piece of tube called a shade is also supplied, to put over the objective to protect it from the glare of the sun.

We add to the Architects Level, when desired, a clamp and tangent movement, which allows the instrument to be clamped more securely, and a movement in a horizontal plane to be made more accurately. See illustration of No. 381.

Adjustments The adjustments of the Architects Level are made exactly as described in the account of the larger levels. They are not liable to derangement, and will ordinarily require but little attention.

TO USE THE ARCHITECTS LEVEL

The instrument should be set firmly upon the tripod or trivet, in a position as nearly level as practicable, the telescope placed over either pair of leveling screws, and the bubble brought into the middle by turning the opposite screws either in or out as may be needed, and both screws brought to a bearing in the little cups underneath. Having brought the bubble into the middle of the vial, turn the telescope over the other pair of screws and repeat the operation.

The instrument having been carefully leveled, focus the eyepiece and objective upon the object as before described, and the horizontal cross wire will give any number of points required, which will be all in the same level plane.

A board held erect will answer as a rod, and a pencil line drawn across it at the place cut by the horizontal wire will give the height of the starting point. Any different points on the rod, either above or below that indicated by the cross wire, will show the difference in height of the various points observed, as compared with the starting point.

In laying off angles with the Architects Level, the bubble **Laying off** should first be brought into the middle as **Angles** before described, and the vertical cross wire made to cut the object or line from which the angle is to be taken. Then, the spindle being clamped by the milled head screw under the circle, the circle is turned around by hand until the zero lines of both circle and vernier are made to coincide. Loosen the clamp screw and turn the telescope to the point desired, and the angle between the two points will be read off on the circle.

By the use of the vernier angles can be read on the circle to five minutes, but ordinarily only even angles will be taken and only the middle line of the vernier used.

The point underneath the center of the instrument is indicated by the point of the plummet suspended from the tripod.

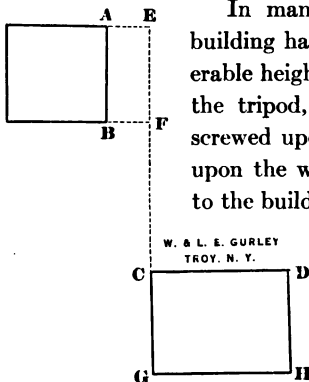

In many cases, after the walls of a building have been carried up to a considerable height, it becomes difficult to set up the tripod, and in this case the level is screwed upon the trivet, which can be set upon the wall or a piece of board secured to the building, or indeed upon any surface nearly level and not less than six inches square.

To illustrate the value of this instrument in laying out the sites of buildings, suppose it is desired to erect a

building, C D, at right angles with a building, A B, and at a given distance from its front.

First set up the level at E, and carefully center the bubble, the point of the plummet below indicating the required dis-

tance of the side of the new building from the front, A B. Measure the same distance at the other corner of A B, and, having erected the rod, sight upon it with the telescope and clamp to the spindle.

Now carry the rod the required distance from B, and move it from side to side until it is again in line with the telescope, as at C.

Remove the instrument, and having carefully set it over the point C, by the plummet, and brought the bubble into the middle as before, set the telescope again upon the rod placed at E or F, and clamp to the spindle. Bring the zeros of the circle and vernier to coincide, unclamp, and turn the vernier to ninety degrees; this will give a point, D, at any required distance from C, and C D will be the side of the proposed building. The side, C G, is determined by turning the telescope around until the vernier is in line with the other zero of the circle, and thus the corner, C, and the two sides, C D and C G, are at once set off, and the remaining corner, H, easily ascertained by making D H and G H equal to C G and C D respectively.

Other uses of the level, as the setting of floor timbers, of window and door sills and the leveling of floors, will readily occur to one who has been engaged in building. To the mill wright such a level is almost indispensable in the aligning and leveling of shafting, in ascertaining the fall of water obtainable, and in determining the overflow of land by a mill pond. The farmer will find it of value in locating and laying out drains, ascertaining the height of springs and similar work.

This level has become widely known, and its cheapness, simplicity, and excellence have created a great demand for it.

DRAINAGE LEVEL**No. 387**

No 387 represents a level combining great simplicity and compactness with real efficiency, at a very moderate cost. The telescope is about nine inches long and is made especially for this instrument, being achromatic, of low but sufficient power, and having good light and definition. The cross wires are fixed in the eyepiece so that they are not easily disturbed. The level, telescope, and socket are enclosed in a strong outside case of brass, about seven and one half inches long, two and one quarter inches wide, and one and one half inches high.

The ends of the case are thickened and made parallel each to each, on the upper and under sides.

A ball attachment, by which the instrument is made approximately level, screws into a spindle which is within the case. The precise leveling is done by the leveling screws, as shown. When desired, the leveling head can be dispensed with, and the instrument leveled by the ball alone.



No. 388

A compass with three inch needle is added to the Drainage Level, when desired. This is fitted to the upper surface of the case and can be removed at pleasure, and while it does not interfere in any way with the reading of the level vial, it fur-

nishes a ready means of determining the bearing of lines or of measuring angles by the needle.

Fixed stadia may be inserted in the telescope of the Drainage Level. The operation is difficult, so that we are obliged to make an extra charge of \$5.00 for the insertion of stadia wires when required.

This level is adjusted almost as simply as an ordinary masons or builders level, in the following manner: The spirit level, by reversing from end to end on the lower faces of the case, and making necessary corrections by the screws at the eyepiece end, marked "L" on opposite faces and in line with the level tube; the telescope, by applying the opposite faces alternately to the same surface, and bringing the telescope cross wires by two screws marked "T," one on each face, so as to cut the same point in both positions of the case. A small block of wood, having a screw thread that fits the top of the ball attachment, is furnished with the instrument, for use in making the above adjustments.

When the ball is screwed firmly to the spindle and the instrument leveled, it should remain level when reversed upon its spindle in any direction. If it does not, correct the error by the two screws on the opposite sides of the case, marked "S." Should the cross wires be indistinct or out of focus, unscrew the cap of the eyepiece and turn the setting of the lens around in either direction until the wires are clearly seen, when the cover may be replaced.

These adjustments are always made by the maker, and are not liable to derangement in the careful use of the level.

To clamp the instrument on the spindle, turn the small milled head screw at the eyepiece end. To screw the ball attachment to the spindle, press in the spring catch

at the bottom of the case, and the ball can then be easily screwed in.

The advantages of this level in the work of the farmer, manufacturer, and builder will be apparent. Drains can be located and leveled, the height of springs ascertained, and the accurate level of lines of shafting, floor timbers, and sills be determined.

The Architects Leveling Rod, hereafter described, is intended for use with this instrument, when desired.



TRIPODS

IN THE tripods of all our instruments, the upper part of the leg is flattened and slotted to fit closely on each side of a tenon projecting from the under side of the tripod head, to which it is firmly held by a brass bolt, with large head and thumb nut on opposite sides of the leg. The tripod head is of the best bell metal, the tenons and upper part being cast in one piece and firmly braced together. The legs are round, and taper in each direction toward the head and point. The point or shoe is a tapering brass ferrule, having an iron end. It is cemented and firmly riveted to the wood.

The legs of all our tripods are made of straight grained hardwood, and are about four feet eight inches long from head to point.

PLAIN TRIPODS

We make four sizes of tripods with solid legs, as follows:

The heavy tripod, No. 400, has a metal head four and one quarter inches in diameter, with legs one and three eighths inches in diameter at the top, one and three quarters at the swell, and one and one eighth near the point. This is used with the Engineers Transit and with the larger Y Levels.

The medium sized tripod has a head the same diameter as the former, and legs which are one and one eighth inches in diameter at the top, one and five eighths at the swell, and one and one sixteenth near the point. This tripod is used with the Surveyors Transit, the light Engineers Transit, and the fifteen inch Level.

The compass tripod, No. 415, has a head about three inches in diameter, and legs which are about one inch in diameter at the top, one and three eighths at the swell, and



Nos. 400 and 430

[Page 224]

seven eighths near the point. This tripod is used with the various compasses and with the Vernier Transit Compass.

The pocket compass tripod is the same pattern as No. 415, but has smaller head and legs. The legs are nearly three quarters of an inch in diameter at the top and bottom, and one and one eighth at the swell.

SPLIT LEG TRIPOD

The improved split leg tripod, Nos. 405 and 435, is shown in the illustration. The form is shown in section at A B.

The legs are of straight grained hardwood, combining stiffness and strength, with reduced weight and allowing greater ease in carrying. We make several sizes of this tripod, for use with transits, levels, and compasses.

EXTENSION TRIPOD

In No. 410 is shown an improvement on the pattern of extension tripod, which has proved so popular. The new tripod is lighter, stronger and more rigid than the old pattern. The form is shown in section at A B.

This tripod can be carried more easily than the old one, and the shape of the side pieces allows the middle piece to be clamped firmly with the two bands and screws, while slight changes in length can be made by twisting the middle piece up or down. The legs are clamped to the tripod head with thumb nuts.

We make several sizes of these tripods. The large size is used with the large transits and levels, and the medium size with the Mountain Transit. A smaller size is used with the smaller transits, Architects Levels, and large compasses, and the smallest size is used with the pocket compasses.



No. 415
[Page 226]



Nos. 405 and 435

[Page 227]



Nos. 410 and 440
[Page 228]

LEATHER CASES AND POUCHES



No. 490

The pouch shown in the illustration furnishes a very convenient method for carrying small pocket compasses without telescopes, as Nos. 288 to 350.

These pouches are strongly made, furnished with adjustable sling strap, and so arranged as to hold the compass and its mountings firmly and protect them from injury in transportation. The wooden box in which the small compasses are packed is omitted when the leather *pouch* is used. The leather *cases*, however, are fitted to hold the wooden box containing the instrument, and are used with any transit, level, compass, or pocket compass.

We have the best facilities for making all kinds of leather work to order, and can promptly furnish anything in the line of cases or pouches for surveying instruments. We also make to order canvas cases for carrying tripods and leveling rods.

LEVELING RODS

ON THE following pages we give illustrations and descriptions of the leveling rods commonly used by American engineers and surveyors, which are manufactured by us in large numbers and kept in stock.

Our facilities for the manufacture of leveling rods have for many years surpassed those of all other makers. The greatest care is exercised in the selection, preparation and seasoning of the wood, and special appliances and machinery for the work have been constructed. Many improvements have been made in design, with a view to producing the best results obtainable, and in point of finish and accuracy our rods are unexcelled.

Special Rods We make to order special rods either from designs furnished or of patterns approved by eminent engineers and are prepared to submit estimates on application.

For many years rods made by us have been regarded as standard for the most critical and exact work, the many tests demonstrating their accuracy beyond question.

PHILADELPHIA ROD

No. 500

This rod is made in two parts, each about three quarters of an inch thick by one and one half inches wide and seven and three tenths feet long, the parts connected by two metal sleeves, the upper one of which has a clamp screw for fastening the two parts together when the rod is extended for a higher reading than seven feet.

Both sides of the back strip and one side of the front are recessed one sixteenth of an inch below the edges. These surfaces are painted white, graduated into feet, tenths and

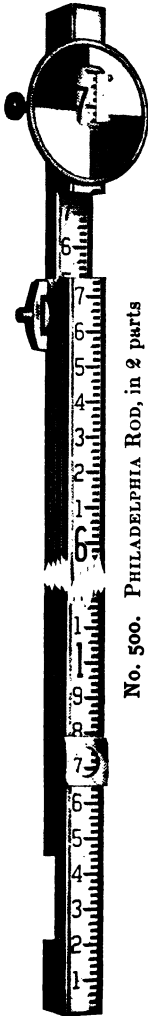

No. 500. PHILADELPHIA ROD, in 2 parts

hundredths of a foot, and the feet and tenths figured. The graduations and figures are slightly impressed on the recessed surfaces, thus increasing their durability.

The edges of the rod and the corners of the brass mountings are rounded, for ease in handling.

The front piece reads from the bottom upward to seven feet, the foot figures being red and the tenth figures black. When the rod is extended to full length the front surface of the rear half reads from seven to thirteen feet, and the whole front of the rod is figured continuously and becomes a self-reading rod, thirteen feet long, reading to hundredths of a foot.

The back surface of the rear half is figured from seven to thirteen feet, reading from the top down. It has a vernier scale by which the rod is read to thousandths of a foot as it is extended. The target is round, made of brass raised on the perimeter to increase its strength, and is painted in white and red quadrants. It has also a vernier scale on its chamfered edge, reading to thousandths of a foot.

When a level of less than seven feet is desired, the target is moved up or down the front surface, the rod being closed and clamped; but when a greater height is required the target is fixed at seven feet and the rear half extended, the vernier scale on the back giving the readings like those of the target to thousandths of a foot.

PHILADELPHIA ROD

In three parts. No. 501

To provide a rod of the same general design and use as the Philadelphia rod, but capable of being closed to shorter length, we have introduced the Philadelphia rod in three parts. This rod is five and three tenths feet long when closed, and when extended reads to thirteen feet.

In reading about five feet the rear part is extended, the readings being made on the graduated edges of the rod by vernier to thousandths of a foot.

When fully extended the front surface becomes a self-reading rod to thirteen feet, the graduations being to hundredths of a foot.

On account of ease in transportation, as well as the general character and excellence of this rod, we believe it will be approved by those who use it.



No. 501. PHILADELPHIA ROD, in 3 parts



No. 503. BOSTON ROD

BOSTON ROD

No. 503

This rod is formed of two pieces, each about six feet long, sliding easily by each other in either direction.

One side is furnished with a clamping piece and screw, with a small vernier at each end; the other or front piece carries the target, and has on each side an inlaid strip upon which graduations of feet, tenths and hundredths are marked and figured.

The target is a disk of brass raised on its perimeter, fastened on the front half, and painted red and white, its middle line being just three tenths of a foot from the end of the rod.

Each tenth graduation is figured decimally in three figures, or to hundredths of a foot, and by the verniers is read to thousandths.

The target being fixed, when any height is taken above six feet the rod is changed end for end, and the graduations read by the other vernier, the height to which the rod can be extended being a little over eleven feet.

This rod is convenient on account of its lightness, but the parts are too frail to withstand the rough usage of this country, and American engineers generally prefer rods which are heavier and more substantial.

TROY ROD

No. 504

The illustration represents another form of the sliding leveling rod, called the Troy rod. This is a self-reading rod up to six feet, or it can be read by a vernier on the rear piece to thousandths of a foot.

It has two targets, as shown, both fastened to the front half of the rod, the lower one having its middle line just three tenths of a foot above the end, and the other target exactly six feet above the lower.

There is a clamping piece with screw on the back of the rod, below the upper target, by which the two parts are clamped together when desired.

The face of the front piece is recessed like that of the Philadelphia rod, painted white, graduated to feet and hundredths, and figured as represented.

The side of the front half is graduated to feet and hundredths, read by a vernier on the top of the rear half to thousandths, and figured from the top downward, beginning with three tenths, that being the height of the middle line of the lower target.

When a level of less than six feet is taken on the rod the observation is made by the lower target, and the reading is direct as given on the side; but when a greater height is taken the upper target is sighted upon, and six feet



No. 504. TROY ROD

added to the reading on the side, a reading up to twelve feet being thus readily obtained.

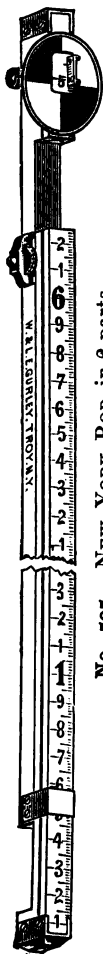

No. 505. NEW YORK ROD, in 2 parts

NEW YORK ROD

No. 505

This rod is made in two parts, the pieces sliding one from the other, the same end being always held on the ground and the graduations starting from that point.

The graduations are made to tenths and hundredths of a foot, the tenth figures being black, and the feet marked with a large red figure.

The front surface, on which the target moves, reads to six and one half feet on the two part rods. When a greater height is required, the horizontal line of the target is fixed at the highest graduation, and the upper half of the rod carrying the target is moved out of the lower, the reading being now obtained by a vernier on the graduated side, up to an elevation of twelve feet.

The target is round, made of brass with a raised rim to strengthen it and to protect from defacement. It is arranged with an improved clamp, which can be so adjusted as to regulate the friction on the rod, allowing the target to be easily moved up and down or to be clamped by a slight turn of the binding screw.

The face of the target is divided into quadrants by horizontal and vertical diameters, the



No. 507. NEW YORK ROD, in 3 parts



quadrants being painted alternately white and red, or sometimes white and black.

The opening in the face of the target is nearly two tenths of a foot long, so that in any position a figure noting a tenth of a foot can be seen on the surface of the rod.

The right edge of the opening is chamfered, and graduated into ten equal spaces corresponding to nine hundredths on the rod. The graduations start from the horizontal line which separates the colors of the face.

The vernier, like that on the side of the rod, reads to thousandths of a foot. The rod is fitted with an improved clamp similar to that on the target.

NEW YORK ROD

In three parts. No. 507

In this rod, as shown, a third piece is added, giving a rod of greater length, and at the same time making it more compact and portable. The graduations, verniers, and readings are the same as those of the rod in two parts.

The three part rod allows a reading of twelve and one half feet, and when closed is five feet long.

MINING RODS

Nos. 502A and 509

Both the Philadelphia rod and the New York rod in two parts are made in lengths suitable for use in underground work, reading

when closed to three and three tenths feet, and sliding to five feet when extended.

ARCHITECTS ROD

Nos. 510 and 511

This is a very light and simple sliding rod in two equal parts, each seven eighths of an inch square, and when closed the rod is about five feet six inches long.

As shown, the front half is graduated on two sides to feet, tenths and hundredths, reading by verniers on the target and side to thousandths of a foot.

The target is similar to those of the rods already described, and moves on the closed rod when levels of less than five and four tenths feet are to be taken.

When a greater height is needed, the target is fixed at the highest graduation, the front half carried above the rear part and clamped by the clamp screw at any point desired, and the height up to ten feet read off by the vernier on the lower half.

This rod is adapted for use with any level, and is so light and efficient that it has been received with favor. It is, however, generally used with the Architects and Drainage Levels. When it is designed for architects use the graduations are in feet, inches and sixteenths, and no verniers are required.

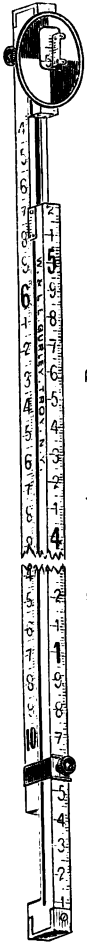

No. 511. ARCHITECTS ROD

MACHINISTS ROD

No. 512

The Machinists rod is in one piece, with a cross section about seven eighths of an inch square, and a length of six and one half feet, and is graduated on one face to feet, inches and sixteenths. Attached to one end of the rod with a swivel is a large hook by which the rod may be hung from a shaft.

The target is painted red with broad white lines crossing the center, and is fitted with candle holder. This rod is designed especially for use in leveling shafting in factories, and, used with the Architects Level, will be found of great service.

TELEMETER OR STADIA ROD

No. 513

This rod is formed of two pieces of pine, each two and one half inches in width and six feet long. The inner surfaces of the rod are recessed and painted white, with graduations in black to feet, tenths and hundredths, the feet figured in red and the tenths in black. The two pieces are connected by strong brass hinges and are folded in transportation. When in use they are opened, laid flat and held firmly in line by a strong clip on the back of the rod. The rod tapers

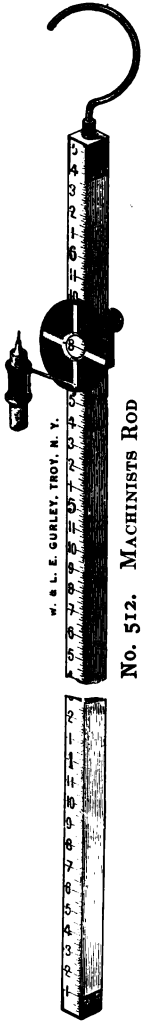

No. 512. MACHINISTS ROD

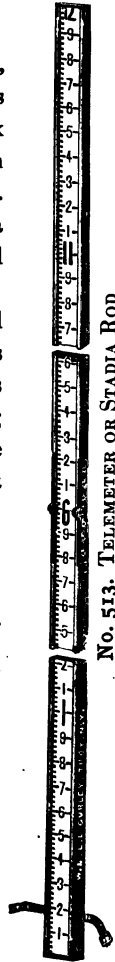

No. 513. TELEMETER OR STADIA ROD

toward the top from a thickness at the bottom of one and one eighth inches.

This is a self-reading rod, and is often used in connection with the stadia to ascertain distances by simple observation, in the same manner as the Philadelphia rod.

TELESCOPIC ROD

No. 515

This rod is so made that the two smaller upper parts slide out of a larger and lower part which answers as a case. When closed, the rod is five feet long, and it extends to fourteen feet. It is graduated on a recessed face to feet, tenths and hundredths, the graduations being painted and figured like those of the Philadelphia and Telemeter rods.



No. 515. TELESCOPIC ROD



CROSS SECTION ROD

No. 516

This rod is made of well seasoned pine, and is ten feet long and one and one half inches square at the ends. It is about four inches thick at the middle, where there is an opening for the hand, as shown. Both sides are graduated on a recessed white surface, the graduations being painted black like those of a leveling rod, and figured from the same end of the rod. There is also an adjustable spirit level at each end, one of which is shown in the illustration.



PLAIN LEVELING ROD

No. 518A

A very good self-reading rod is made of seasoned white pine, recessed and graduated on one face like the Philadelphia rod. A rib at the back, extending through the length of the rod, gives great rigidity, while it does not materially increase the weight. This rod is commonly made ten and twelve feet long, but can be made longer if desired, at an additional cost of about fifty cents per foot. This rod is also made with a hinge joint at the middle.



No. 518A. PLAIN LEVELING ROD



HINGE JOINT FOR PLAIN RODS

PLAIN LEVELING ROD

In four parts. No 524A

This is a simple form of self-reading rod in four parts, very light and compact, capable of extension to eleven and two tenths feet, and reading to hundredths of a foot. This same form of rod is also made in two parts, extending to ten, twelve, or fourteen feet. See Nos. 522A, B and C.



No. 524A. PLAIN LEVELING ROD, in 4 parts

METRIC RODS

Besides the usual graduation of leveling rods into feet and parts of a foot, we graduate them, when desired, into meters, decimeters, and centimeters.

The scales on the targets and sides of the rods read the centimeters to millimeters on all except the tele-meter, telescopic and plain rods, which have no targets and are read only to centimeters. The New York, Troy, Boston, and Architects metric rods are graduated, when desired, to read by vernier to one tenth of a millimeter.

FLEXIBLE OR POCKET LEVELING RODS

Nos. 525A to 528

A convenient form of self-reading rod, where only approximate results are essential, is the flexible or Pocket Leveling Rod, see Nos. 525A-528, of the Price List.

This rod is made of specially prepared canvas, graduated on its painted surface to feet, tenths and hundredths, or to special design, and when not in use it can be rolled up and carried in a case or in the pocket. In use it is fastened to a board with thumb tacks.

LEVELING POLE

The leveling pole, No. 530, is a combination of a plain self-reading rod and a flag pole. It is made with flat face, front and rear, and rounded sides. One face is graduated to feet and hundredths of a foot, while the other face and sides are graduated to feet only and are painted red and white alternately.



No.
530

The pole is made seven and nine feet long, the graduated faces reading to six and eight feet respectively, and when used as a rod is read as shown in the illustration.

WOOD AND IRON FLAGSTAFFS

We make three sizes of the common wood flag-staffs, or ranging poles, Nos. 534, 535 and 536. They are octagonal in form, tapering from the bottom to the top, are six, eight, and ten feet long, and have steel shoes.

We also make a ranging pole, No. 539, of an iron tube, eleven sixteenths of an inch in diameter, hung in gimbals so that it can be readily set over a given point. Similar iron poles are made without gimbals, six, eight, and ten feet long.

These staffs are graduated to feet, and painted alternately red and white. When desired they are also graduated metrically, five spaces to each meter.

JOINTED RANGING POLE

Nos. 537A to 538B

For use where compactness is a requisite, we make a ranging pole having one or more protected screw joints. This pole is about one inch in diameter, and is furnished, if desired, with a heavy canvas case to contain the several parts, and to protect them from injury in transportation.



No.
534



No.
539

ROD LEVEL

No. 545 represents a level for the accurate plumbing of leveling rods and ranging poles. The figures show it when folded for carrying, and also as attached to a rod.

It is held in place by the hand, or it may be secured by a string or rubber band slipped over hooks attached to each plate of the level. Its convenience and value have commended it to general favor.

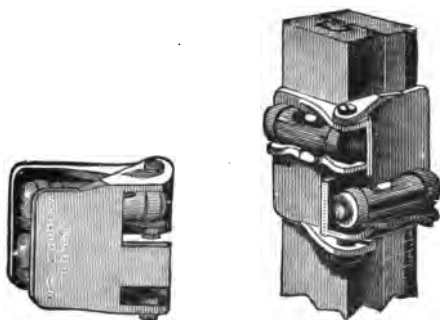

No. 545. ROD LEVEL ROD LEVEL AS APPLIED TO A ROD

CIRCULAR ROD LEVEL

We also make a rod level with circular level vial, folding against the rod when not in use. This level is to be attached to the rod, and hence cannot be used where there is a target or clamp band to slide past it. It is very serviceable on self-reading and stadia rods. See No. 546 of the Price List.

For use where greater accuracy and ease of observation is required, we make the circular level, No. 547.

The case, with vial 30 millimeters in diameter, is supported on a bracket which may be securely attached to the rod. Three screws fasten the case to the bracket and provide means of ready adjustment.

The glass body of the vial is hermetically sealed, thus absolutely preventing any leaking of the fluid.



No. 547

PLANE TABLE



No. 553

THE recognized utility of the Plane Table for topographical and map drawing is bringing it into use in this country, and to meet the demand for instruments of moderate cost and real efficiency, we have introduced several patterns.

The plane table consists mainly of a drawing board mounted upon a firm tripod, as shown in No. 553, having upon its upper surface a movable straight edge or alidade, arranged either with sight vanes or a telescope, by which it may be directed to any point, a line being then drawn on the paper along the edge of the alidade.

A square brass plate, to which is attached a compass with three inch needle and two spirit levels, is also shown, and serves both to level the table and, when applied by the edges parallel to the zero lines of the compass circle, to determine the magnetic bearing of the lines drawn on the paper, or the direction of the table itself.

The table is of wood arranged in sections to prevent warping, and has an adjustable wooden roller at each end, by which the paper is brought down snugly to the board, or upon which a long sheet can be rolled and unrolled. Sometimes in place of the rollers, and often in connection with them, a number of brass clamps are used, as shown, to hold the paper firmly.

Another method of fastening the paper to the board is by small brass screws passing through the paper and into brass sockets let into and slightly below the surface of the board. This method allows the alidade to move over the surface without interference.

The plumbing arm, shown in the figure, has its end brought to a point, that it may be set at any given place upon the paper, the plummet hanging from the under arm determining the corresponding point on the ground. The lower arm moves upon a hinge, an index on the side showing when the ends of the two arms are plumb with each other as applied to the table.

The construction of the socket and tripod head is shown on page 247, *A* representing the hemispherical concave metal cup fastened by six screws to the wooden top of the tripod, *B* the upper or convex part fitting into the cup and clamped to it by the clamping piece, *C*, and nut, *D*. A strong spiral spring in the hollow

cylinder between *C* and *D* serves to hold the two spherical surfaces of the socket together, and allows the easy movement of one within the other in the leveling of the table.

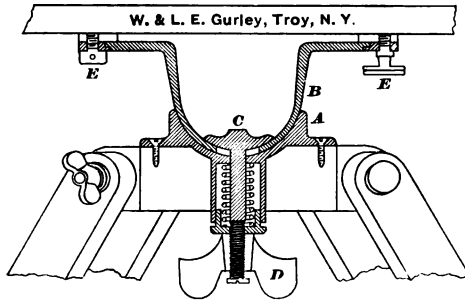

The flange of the socket *B* supports the table, and is connected with it by three segments of brass, two of which are shown at *E E*. The table can be oriented at will, and clamped by a milled head screw passing through one of these segments.

PLANE TABLE WITH LEVELING SCREWS AND TANGENT MOVEMENT

The illustration on page 248 shows a modification of the simple plane table, there being added a tangent movement in azimuth and three screws for leveling.

In detail, the socket and leveling screws and tangent movement, are shown in the illustration at the side. By these a more delicate orienting may be obtained than by the method before described.

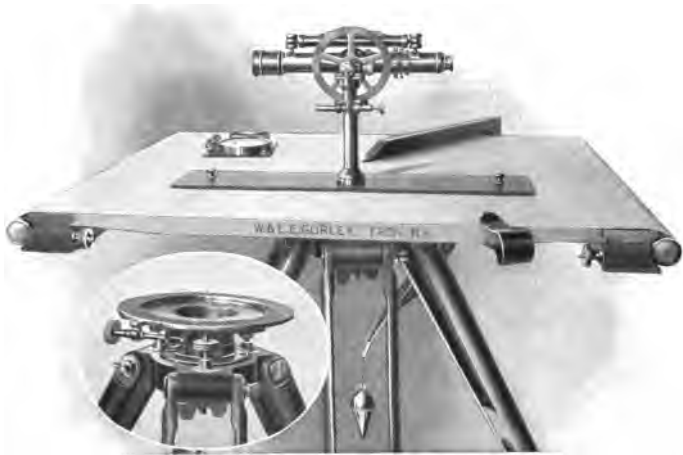

No. 549. PLANE TABLE OUTFIT

TO USE THE PLANE TABLE

The tripod is set up firmly, and the board with the upper half of the spherical socket attached is placed upon the lower half of the socket fastened to the tripod, the wing clamping nut being screwed up until the table is secure upon the tripod. The board is moved by the pressure of the hand, or by the leveling screws, until the level bubbles upon the compass plate will remain in the middle upon any part of the surface. The wing nut is then screwed up and the board made firm upon the tripod.

Any place on the drawing board may be assumed as a starting point, its position over a given point on the ground being determined by the plumbing arm and plummet. From the given point on the paper, sights can be taken to different corners of the field, and lines drawn on the paper along the edge of the alidade. Thus a miniature of the tract can be traced on the paper, the bearing of any line being ascertained by applying the side of the compass plate to the edge of the alidade placed on that line. The table can be oriented, either by the hand, on releasing the milled head screw which clamps the flange, or by the tangent screw as before described.

The measurement of distances by the stadia wires of the telescope, and of vertical angles by the circle, is effected as already described in our account of the transit.

JOHNSON PLANE TABLE MOVEMENT

We illustrate on page 250 what is known as the Johnson Plane Table movement, complete with large alidade, plumbing arm and compass.

The side illustration shows the construction of the movement alone. It has been largely used by the topographers of the U. S. Geological Survey.

As shown, this movement supplies an arrangement whereby the table can be easily made horizontal and then secured by the large wing nut, A. To orient the board, the wing nut, B, is loosened, leaving the hemispherical surface, bearing the board secured to the flange, free to turn, and it can be clamped by screwing up the same nut. This movement as modified in recent years supplies an extremely efficient and portable plane table.

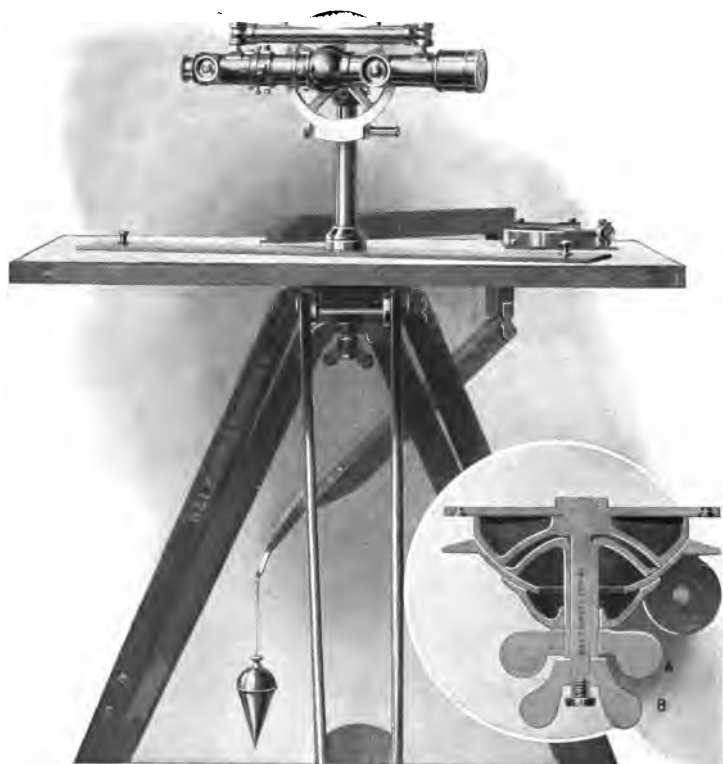

No. 576

JOHNSON PLANE TABLE OUTFIT

The movement with legs complete weighs about nine pounds. The legs are of straight grained second growth hickory, and the construction of the whole tripod insures strength and accuracy, and it is capable of standing rough usage without getting out of order.

Any of the alidades, as described on pages 251 to 255, can be used with the Johnson Plane Table.

ALIDADES

The patterns of our plane tables vary mainly in their alidades, of which we make several kinds.



No. 580

The simplest alidade is shown above, and consists of a brass ruler or straight edge, twenty inches long and about three inches wide, at the ends of which sight vanes are mounted, like those of the compass. The edge of the ruler is chamfered and in line with the slots of the vanes.



No. 581

The illustration No. 581 shows the alidade to which is fitted the telescopic sight, having a level, clamp and tangent, and vertical circle reading to five minutes attached to the telescope, which has also stadia wires. The telescope is placed in line with the fiducial edge of the ruler.

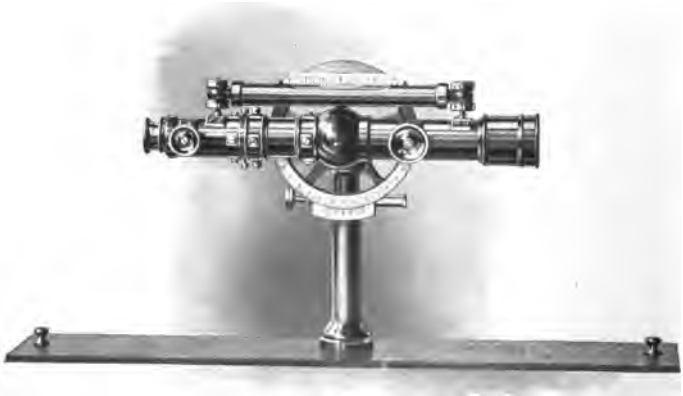

No. 583

Another pattern of alidade, No. 582, is shown in the illustration of the plane table on page 245, the brass ruler being three inches wide. The column supports the telescope with its attachments. The vertical circle is graduated on silver and reads to one minute. The telescope is nine inches long with a power of twenty diameters, and is provided with stadia wires and adjusted like the telescope of the transit.



No. 584A

In the alidade shown in No. 583 the telescope is the same as that used in our best transits, having level, clamp and tangent, vertical circle graduated on silver and reading to one minute, and stadia wires for measuring distances.

It is placed on a brass ruler four inches wide, and is adjusted and used in the same manner as the one just described.

In alidade No. 584A, shown in the illustration, the blade is eighteen inches long and three inches wide, and carries a circular spirit level, the glass body of which is made in one piece hermetically sealed, and a telescope eleven inches long

with stadia wires, detachable striding level, vertical arc and axis tangent, mounted on a column. For easy adjustment of the line of collimation the telescope can be turned on its axis through 180° . The vertical arc reads by vernier to one minute, and as the zero is at one end all the angles read are positive.

The telescope is made either inverting or erecting, as desired, and is fitted with a diagonal prism with darkener, as shown. A rectangular box compass, with four inch needle, and attached to the alidade, is also furnished when desired.

TRAVERSE PLANE TABLE

The illustration, No. 586, represents a simple form of plane table and alidade, first made by us for the U. S. Geological Survey, and in its present improved form used extensively for traverse work. The board is fifteen inches square, and has on its under side a strong brass flange with spring, in which the plunger clamp of the tripod head engages, allowing the



No. 586

board to be clamped or oriented as desired. Small clamp screws with sockets for holding the paper are often placed at the corners of the board.

The alidade consists of a brass ruler ten inches long, graduated on the beveled edge to a scale of forty parts to the inch, and having at each end hinged sights which fold close to the surface of the ruler. The alidade is furnished with a leather pouch. Inserted in one edge of the board is a small box compass with needle about four inches long.

The tripod legs are attached to a head which has a clamping screw passing through its center, compressing a concealed spring and holding the board to the tripod head when oriented to position.

The whole, while not capable of as accurate work as the larger plane tables, constitutes a light and portable instrument for topography.

POCKET ALIDADES

A pocket alidade, of a pattern like the one shown with the Traverse Plane Table, is made six inches long and has hinged sights which fold close to the ruler. The beveled edge is graduated to scale of one forty five thousandth and one ninety thousandth, each graduation representing respectively one twentieth or one fiftieth of a mile.

Another form of the pocket alidade is made seven inches long, with a peep hole for the near sight, and for the other a folding sight graduated for a vertical scale representing a rise of twenty five feet to the mile. The beveled edge is graduated the same as the six inch alidade described above. The ruler carries an adjustable level with knurled head leveling screw.

THE ARMY SKETCHING CASE

Designed and patented by GLENN S. SMITH, Topographer, U. S. Geological Survey

THIS instrument for topographic map making was originally designed for the use of Army Engineers, but since its introduction has been found of great service for a similar class of work by foresters, geologists, timber cruisers and civil engineers.

In addition to the simplicity and strength of construction fitting it for general use, it possesses a unique feature in that the board does not require to be oriented in taking observations.

The Army Sketching Case consists of a plane table board, six by twelve inches, to the lower right hand side of which is attached a compass box with floating dial, three inches in diameter, beveled on the edge and graduated to three hundred and sixty degrees.

A protected opening in the compass box permits the graduated dial to be read either from above or when the board is held level with the eye of the observer.

In line with the center of the compass and parallel with the edge of the board are placed rifle sights, which are used as an alidade in taking bearings.

On the upper side of the board is mounted a circular plate, six inches in diameter, and pivoted at the center. This plate is attached to an L shaped base at the upper end of which is a cylinder through which passes a rod parallel with and secured to the top of the board.

A metal strip let into a slot in the middle of the board guides the lower edge of the L shaped base.

Upon the guides as described, the base carrying the circular plate can be moved from side to side over the upper



No. 594 ARMY SKETCHING CASE

surface of the board and clamped at will by a set screw in the cylinder at the top.

A clamp with index line is so attached to the base that the circular plate mounted upon it may be set at any desired position.

To the surface of the circular plate is attached a card of aluminum having printed upon it a combined protractor and scale.

The protractor is graduated to three hundred and sixty degrees and the scale consists of a series of equally spaced concentric circles.

Different protractor cards are furnished for the various scales used in map making.

Rollers with friction brakes at the top and bottom of the board receive the paper and hold it snugly against the surface of the protractor which travels underneath it and an aluminum shield protects the paper and prevents soiling when carrying the case.

To the under side of the board is attached a strap by which the case is carried, and there is also a socket by which a tripod may be attached for use with the board if desired. A simple clinometer for taking slopes is also provided.

As far as possible the metal parts are made of aluminum, thus reducing the weight of the case to two pounds.

Care in the selection of a proper material for use on the case in recording observations is essential to successful operation and tracing cloth should be avoided as too smooth for the use of a pencil. Vellum tracing paper which has a slightly roughened surface, little affected by moisture and on which the pencil works well, is recommended. This paper we are prepared to supply.

Directions for the use of the Smith Sketching Case will be furnished on application.

BATSON SKETCHING CASE

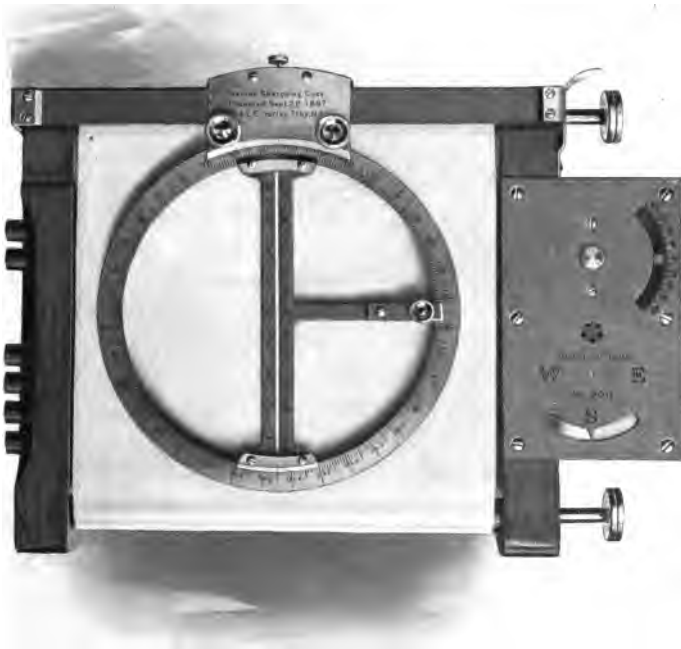

No. 595

THE illustration shows the Batson Sketching Case, designed for the use of civil and military engineers and surveyors in reconnoissance and topographical surveys. It was given an extensive and successful trial, in 1898 and 1899, in Cuba and the Philippines, as well as in the United States.

This instrument is a small drawing board, having upon its upper surface a movable graduated circle, carrying a small alidade with scales. At one end of the board are a compass and a clinometer.

The drawing board is of wood and is provided with rollers which carry the paper for recording observations. Friction brakes hold the rollers, so that the paper is held down snugly to the board and prevented from uncoiling. Six holes at the end of the board opposite the compass afford receptacles for the pencils used in topographical sketching.

The protractor is held in position by a carrier which slides upon a bar attached to the wooden end pieces, as shown. The construction of the carrier allows the protractor to be turned, or to be clamped by means of two set screws, if desired. The protractor can also be lifted to an upright position, by pulling back the spring catch at the end of the carrier bar. The alidade turns within the graduated circle, and with it forms the protractor.

The paper for use with this instrument is six inches wide, and from thirty to forty inches is found to be a convenient length.

The sketching case is fitted with a strap for carrying on the forearm, and, if desired, is provided with a short, light staff or a tripod, for use in taking bearings on reference points and on objects which it is desirable to locate more accurately than is possible when holding the instrument in the hand.

A sole leather case, having a pocket for the instrument and another for sketches and extra paper, and fitted with lock and shoulder strap, is provided with each instrument.

A special circular giving full instructions for the use of the Batson Sketching Case will be supplied on application.

CURRENT METERS

FOR more than twenty five years Current Meters have been made by W. & L. E. Gurley under the patents of W. G. Price, the United States Engineer, who in 1885 devised the initial pattern, the general features of which have been followed in subsequent meters, although greatly modified as the result of the suggestions of hydraulic engineers, who have had large experience in current meter observation under all conditions of service.

The many hundred current meters of our make in use in all parts of the world, their constantly increasing use and their accuracy and reliability under all conditions, show that they are standard instruments for the accurate measurement of the velocity of water in streams.

The distinguishing features of our current meters are:

No exposed mechanism

No delicate parts to get out of order

Simplicity of construction

Rigidity combined with light weight

Continuous reliability in action

Adaptability for different conditions of service

The largest meter which we make is No. 600; of heavy and substantial construction in order to permit its use when the force of the current is great and the consequent requirement is for an instrument which will withstand extraordinarily hard usage.

Experience has demonstrated that, for ordinary use, a meter of much lighter construction will accomplish equally satisfactory results, while much more easily transported.

Our smaller meters are Nos. 616, 617, 618, 621 and 623.



No. 609

ELECTRIC REGISTER

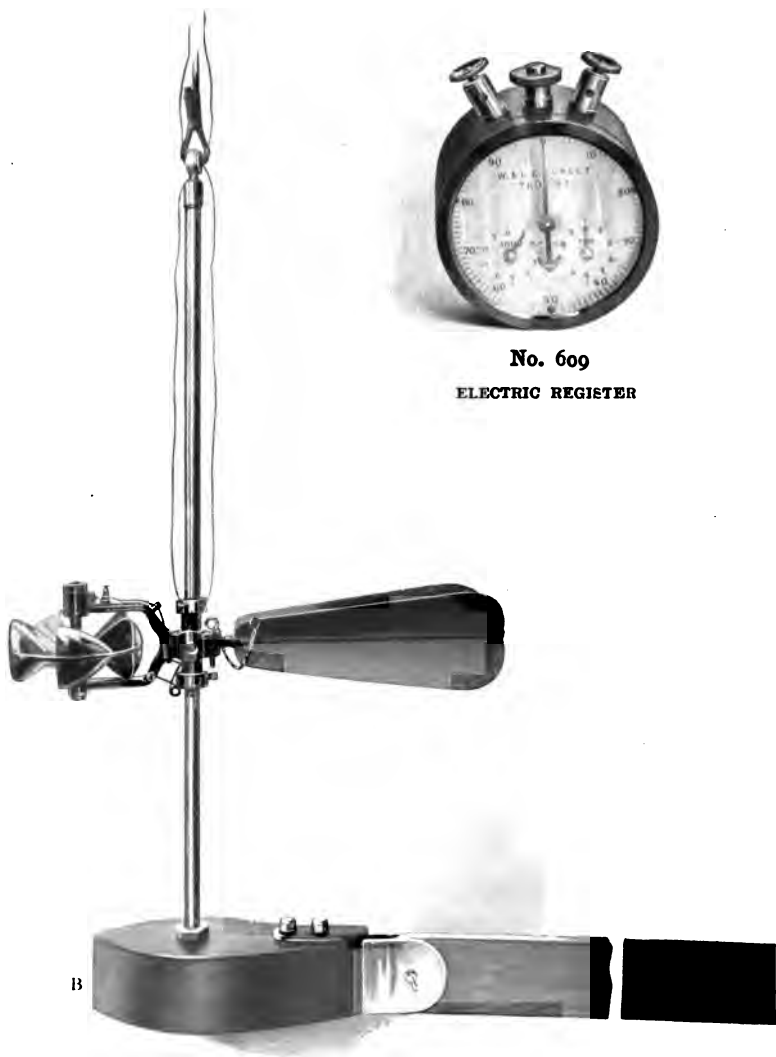

B

Nos. 600 and 606

CURRENT METER AND LEAD WEIGHT AND ROD

No. 616 is called the Acoustic Current Meter, because the revolutions of the bucket wheel are indicated by a hammer striking against a diaphragm, one blow for every ten revolutions. The indicating mechanism is enclosed and thoroughly protected from injury. The meter is held by a jointed rod, which screws into the frame and in connection with a rubber tube and ear piece attached to it, forms a passage through which the sound of the hammer stroke is transmitted to the ear of the observer, enabling him to count the number of revolutions of the wheel in any given space of time, and then by means of the reduction table to ascertain the velocity of flow.

The Acoustic Current Meter will give accurate results when it is possible for the observer to come closely at the stream, as his range of observation is necessarily restricted to places where he can hold the meter by its suspending rod.

By reason of this limitation the preference is for a current meter where the revolutions of the bucket wheel are indicated by means of an electric current, allowing the meter to be suspended by a wire or cable in positions where it is not possible for the observer to come closely at the stream.

We make four kinds of small electric current meters, Nos. 617, 618, 621 and 623.

In size and general construction these meters are similar and their parts are interchangeable, but differ in certain particulars which will hereinafter be described.

In all, the indicating device is protected from injury by enclosure in the contact chambers and the revolutions of the bucket wheel are transmitted by a telephone ear piece to the ear of the observer, the ear piece being ordinarily secured in a convenient position on the coat.

Meter No. 617 indicates each revolution of the bucket

wheel and is suspended in use by a wire or cable attached to a steel bar passing through the frame of the meter and allowing also the suspension of a lead weight to keep the meter in the current of the stream.

A tail consisting of a stem to which are fastened two vanes (separable in packing) is attached to the frame opposite the bucket wheel and serves the double purpose of balancing the bucket wheel and keeping the meter parallel to the direction of the current.

Meter No. 618 is a modification of Meter No. 617 in that the vane is omitted, the yoke or frame provided with a base by which the meter may be set in the bed of a stream and suspension made by a tube which is screwed in the frame, permitting the meter to be held by the observer.

This meter indicates every revolution of the bucket wheel electrically by a telephone sounder.

In Meter No. 621 provision is made in the contact chamber so that every fifth revolution of the bucket wheel is indicated, otherwise the construction is identical with that of No. 617.

In Meter No. 623 we have recently introduced other important and valuable improvements fitting it for a more extended and varied service.

Two contact chambers, one to indicate every revolution and one every fifth revolution of the bucket wheel, are provided.

The chambers may readily be exchanged the one for the other on the frame of the meter the only other change being in the shaft and consisting of the insertion on the end of the bucket shaft of a cam when a single revolution is to be indicated or of a worm when it is desired to indicate every fifth revolution.

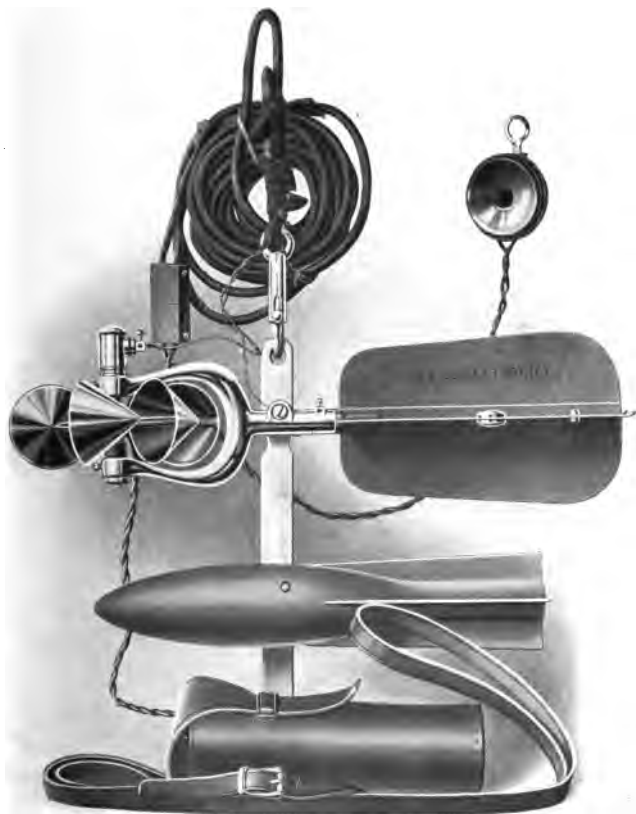

No. 617

ELECTRIC CURRENT METER



No. 618

ELECTRIC CURRENT METER

In addition a screw socket is provided on the frame of the meter to receive a series of rods by which the meter may be suspended, if desired, by the observer, no change being made in the meter except the removal of the weight stem. This modification is called from its designer the Covert Yoke.

Meter No. 623 thus combines Meters Nos. 617 and 621, and enables observation to be made for high or low velocities as required. The instrument has met with a large sale since its introduction and is highly approved by hydraulic engineers.

Various accessories are furnished with the current meter, such as lead weights, wading rods, time recorders, etc.

The lead weights used with Meters Nos. 617, 621 and 623 are torpedo shaped and have vanes so that they will remain parallel with the direction of the current.

The number and position of the weights on the stem depend on the condition under which the measurement is to be made.

The wading rods used with meters Nos. 617 and 621 have flush joints to allow the hanger supporting the meter to be clamped at any required height on the rod.

The hanger by which the meter is suspended on the rod has two opposite heads which receive, the one the frame and bucket wheel and the other the vane of the meter which is separated from the meter when used with the rod.

The wading rods are made in sections, in lengths of 1 foot, $1\frac{1}{2}$ feet and 2 feet, and are generally furnished with a base which may be attached when desired.

A leather carrying case to contain rods and base is also supplied when required.

A time recorder or stop watch of fine quality will also be

found desirable in observing the revolutions of the bucket wheel for any given time.

The illustrations will give a good idea of the general construction of the current meter, but more detailed information may be obtained by correspondence.

USE AND CARE OF THE CURRENT METER

The Engineer using the current meter should carefully note the following directions from a paper prepared by John C. Hoyt, Am. Soc. C. E., on the use and care of the current meter as practised by the United States Geological Survey.

1. Be sure that the set screws are all tightened before putting the meter in the water; otherwise one of the parts may be lost.

2. Loosen the sleeve nut and see that the meter runs freely before beginning a measurement; and spin the meter cups occasionally during a measurement to see that they are running freely.

3. See that the weights play freely on the stem, so as to take the direction of the current and thus avoid a drag on the line.

4. If any apparent inconsistency in the results of an observation throws doubt on its accuracy, investigate the cause at once. Grass may be wound around the cup shaft; the cups may be tilted by tension on the contact wire; the channel may be obstructed immediately above the meter; the meter may be in a hole; or the cups may be bent so as to come in contact with the yoke.

5. After a measurement, clean and oil the bearings (in order to prevent rust) and inspect the cone point.

6. In packing the meter, turn the sleeve nut to lift the cups from the cone point.

7. Always see that the lock nut on the cone point is firmly screwed against the cone plug.

8. If the cone point is dulled, it can be sharpened with an oil stone.

9. In measuring low velocities, be sure that the meter is in a horizontal position. If it has a tendency to tip, it can be held in place by using a plug in the slot for the stem.

10. Avoid taking measurements in velocities of less than $\frac{1}{2}$ ft per sec., as the accuracy of the meter diminishes as zero velocity is approached.

11. For velocities of less than 1 ft. per sec., the bearing point should be sharp and smooth, as at the time of rating. As the velocity increases, the condition of the point is less important, for then the friction becomes a small factor.

12. In taking measurements at high velocities, sufficient weight, or a stay line, should be used to hold the hanger so that the meter will remain horizontal.

13. In very shallow streams the meter should be suspended from the lower hole on the stem, and the weight should be placed above.

14. If the cups of a small Price Meter are bent, they may easily be put in place by using a wood or metal bar with a round, smooth end.

15. The telephone receiver is very sensitive to electric currents, and can be used to locate any break in the circuit. First try the telephone and battery together in a circuit having a make-and-break point. This may be done by using a knife blade or a screw driver, making connection where the wires enter the plug. If there is no click in the telephone, then the battery or the telephone does not make a circuit. If there is a click, insert the meter in the line and test for a contact in the meter head by revolving the meter wheel. If the meter is all right, put the meter cord in the circuit and test both sides by making double connection and touching alternate sides of the line.

16. When the meter is not in use, disconnect the meter line from the battery, so that it will not become exhausted.

17. The amount of current necessary to work with a telephone receiver is very small, and a battery may be serviceable even though nearly exhausted.

18. If care is taken, it is improbable that the telephone receiver will get out of order.

19. Do not strike the telephone receiver, as a heavy jar will, to a greater or less extent, demagnetize the pole pieces, and to that extent will injure the receiver.

20. Care must be taken not to short circuit the dry battery when the meter is not in use, as in that way the cell becomes exhausted in a short time, the energy being used in heating the cell. To avoid this, the poles are wound with adhesive tape.

21. If a dry cell which has been long in stock fails to work well, punch two nail holes in the wax on top of the cell and put it in water over night, when it will absorb enough moisture to renew it. The holes should then be coated over by heating the wax with a match and pressing it into place, or by pouring in melted paraffin. A cell which has been exhausted by use is not benefited much by this treatment. The life of a cell depends largely on the amount of leakage in the line during use.

**REDUCTION TABLE FOR USE WITH
ELECTRIC CURRENT METER**

PATTERN No. 600

This table is a mean of the ratings of many different Meters and will probably give correct values within one per cent for any Meter of its pattern in good order

Time In Seconds	VELOCITY IN FEET PER SECOND					
	5 Revs.	10 Revs.	20 Revs.	30 Revs.	40 Revs.	50 Revs.
40	0.555	0.950	1.74	2.53	3.32	4.11
41	0.545	0.930	1.70	2.48	3.24	4.01
42	0.536	0.912	1.66	2.43	3.17	3.92
43	0.527	0.894	1.63	2.37	3.10	3.84
44	0.518	0.877	1.60	2.32	3.03	3.76
45	0.509	0.861	1.56	2.27	2.97	3.68
46	0.501	0.846	1.53	2.22	2.91	3.60
47	0.495	0.831	1.50	2.17	2.85	3.52
48	0.488	0.817	1.48	2.13	2.79	3.45
49	0.482	0.804	1.45	2.09	2.74	3.38
50	0.476	0.792	1.42	2.06	2.69	3.32
51	0.469	0.782	1.40	2.03	2.64	3.26
52	0.463	0.763	1.38	2.00	2.59	3.20
53	0.457	0.753	1.35	1.96	2.54	3.14
54	0.453	0.744	1.33	1.92	2.50	3.09
55	0.448	0.735	1.31	1.88	2.46	3.03
56	0.443	0.726	1.29	1.85	2.42	2.98
57	0.438	0.715	1.27	1.82	2.38	2.93
58	0.433	0.705	1.25	1.79	2.34	2.88
59	0.427	0.696	1.22	1.76	2.30	2.83
60	0.423	0.689	1.21	1.74	2.27	2.79
61	0.419	0.678	1.19	1.71	2.23	2.75
62	0.416	0.669	1.18	1.69	2.20	2.71
63	0.413	0.661	1.16	1.66	2.16	2.67
64	0.410	0.653	1.15	1.64	2.13	2.63
65	0.405	0.646	1.13	1.61	2.10	2.59
66	0.401	0.639	1.12	1.59	2.07	2.55
67	0.397	0.632	1.10	1.57	2.04	2.51
68	0.392	0.625	1.09	1.55	2.02	2.48
69	0.388	0.618	1.07	1.53	1.99	2.45
70	0.384	0.612	1.06	1.51	1.96	2.42

W. & L. E. Gurley, Troy, N. Y.

REDUCTION TABLE FOR USE WITH
ELECTRIC CURRENT METER
PATTERN No. 600—Continued

Time In Seconds	VELOCITY IN FEET PER SECOND					
	60 Revs.	70 Revs.	80 Revs.	90 Revs.	100 Revs.	150 Revs.
40	4.89	5.60	6.34	7.07	7.81	11.48
41	4.77	5.48	6.19	6.91	7.63	11.21
42	4.66	5.37	6.05	6.75	7.46	10.95
43	4.56	5.25	5.93	6.62	7.29	10.73
44	4.46	5.13	5.81	6.49	7.13	10.48
45	4.37	5.03	5.68	6.36	6.98	10.26
46	4.28	4.93	5.57	6.22	6.84	10.04
47	4.20	4.84	5.47	6.10	6.71	9.83
48	4.13	4.75	5.37	5.98	6.59	9.63
49	4.04	4.66	5.26	5.86	6.48	9.45
50	3.95	4.58	5.16	5.75	6.36	9.28
51	3.87	4.50	5.07	5.65	6.23	9.10
52	3.79	4.43	4.99	5.55	6.11	8.93
53	3.73	4.35	4.90	5.46	6.00	8.78
54	3.67	4.28	4.81	5.37	5.90	8.63
55	3.60	4.20	4.73	5.28	5.81	8.58
56	3.54	4.13	4.65	5.19	5.72	8.34
57	3.47	4.05	4.58	5.10	5.62	8.20
58	3.41	3.98	4.51	5.02	5.52	8.07
59	3.36	3.92	4.44	4.95	5.44	7.94
60	3.32	3.86	4.37	4.89	5.37	7.81
61	3.27	3.79	4.31	4.80	5.28	7.69
62	3.22	3.73	4.25	4.72	5.19	7.57
63	3.17	3.66	4.19	4.67	5.12	7.45
64	3.13	3.60	4.13	4.58	5.05	7.34
65	3.09	3.55	4.05	4.52	4.97	7.23
66	3.04	3.51	3.98	4.46	4.90	7.13
67	2.99	3.46	3.92	4.40	4.84	7.03
68	2.95	3.41	3.86	4.34	4.78	6.94
69	2.91	3.36	3.81	4.29	4.72	6.85
70	2.88	3.32	3.76	4.24	4.66	6.76

W. & L. E. Gurley, Troy, N. Y.



No. 616

PRICE PATENT ACOUSTIC CURRENT METER

REDUCTION TABLE FOR USE WITH
ACOUSTIC CURRENT METER

PATTERN No. 616

This table is a mean of the ratings of many different meters, and will probably give correct values within one per cent for any meter of its pattern when in good order.

The time column is the number of seconds that have elapsed during one hundred revolutions of the wheel, there being ten revolutions to each rap.

TIME	VELOCITY	TIME	VELOCITY	TIME	VELOCITY	TIME	VELOCITY
1000	0.27	111	2.11	59	3.96	37	6.28
666	.39	105	2.22	57	4.08	36	6.51
500	.50	100	2.34	56	4.20	34	6.74
400	.61	95	2.46	54	4.31	33	6.98
333	.72	91	2.57	53	4.43	32	7.21
286	.83	87	2.69	51	4.54	31	7.44
250	.95	83	2.80	50	4.66	30	7.67
222	1.07	80	2.92	49	4.78	29	7.91
200	1.18	77	3.03	48	4.90	28	8.25
182	1.30	74	3.15	46	5.01	27	8.48
167	1.42	71	3.26	45	5.12	26	8.83
154	1.53	69	3.38	44	5.24	25	9.29
143	1.65	67	3.50	43	5.35	24	9.64
133	1.77	65	3.61	42	5.58	23	10.10
125	1.88	62	3.73	40	5.82	22	10.56
118	1.99	61	3.85	38	6.05	21	11.02

**REDUCTION TABLE FOR USE WITH
ELECTRIC CURRENT METERS**

PATTERNS Nos. 617, 618, 621 AND 623

This table is based on the ratings of many meters. The comparison of the ratings of meters Nos. 617, 618, 621, and 623, both penta recording and single point contact, show an agreement with this table within one per cent.

Occasional ratings vary more than one per cent when an individual rating table may be prepared.

Time In Seconds	VELOCITY IN FEET PER SECOND					
	5 Revs.	10 Revs.	20 Revs.	30 Revs.	40 Revs.	50 Revs.
40	0.31	0.58	1.13	1.68	2.23	2.78
41	0.30	0.57	1.10	1.64	2.18	2.71
42	0.30	0.56	1.07	1.60	2.13	2.65
43	0.29	0.54	1.05	1.56	2.08	2.59
44	0.28	0.53	1.03	1.53	2.03	2.53
45	0.28	0.52	1.01	1.50	1.99	2.48
46	0.28	0.51	0.99	1.47	1.95	2.43
47	0.27	0.50	0.97	1.44	1.91	2.38
48	0.26	0.49	0.95	1.41	1.87	2.33
49	0.26	0.48	0.93	1.38	1.83	2.28
50	0.26	0.47	0.91	1.35	1.79	2.23
51	0.25	0.46	0.90	1.32	1.75	2.19
52	0.25	0.46	0.88	1.29	1.72	2.15
53	0.24	0.45	0.86	1.27	1.69	2.11
54	0.24	0.44	0.85	1.25	1.66	2.07
55	0.24	0.43	0.83	1.23	1.63	2.03
56	0.23	0.43	0.82	1.21	1.60	1.99
57	0.23	0.42	0.80	1.19	1.57	1.96
58	0.22	0.41	0.79	1.17	1.54	1.93
59	0.22	0.41	0.78	1.15	1.51	1.90
60	0.22	0.40	0.77	1.13	1.48	1.87
61	0.22	0.39	0.75	1.11	1.46	1.84
62	0.21	0.39	0.74	1.09	1.44	1.81
63	0.21	0.38	0.73	1.07	1.42	1.78
64	0.21	0.38	0.72	1.05	1.40	1.75
65	0.20	0.37	0.71	1.03	1.38	1.72
66	0.20	0.37	0.70	1.02	1.36	1.69
67	0.20	0.36	0.69	1.01	1.34	1.66
68	0.20	0.36	0.68	1.00	1.32	1.64
69	0.19	0.35	0.67	0.99	1.30	1.62
70	0.19	0.35	0.66	0.98	1.28	1.60

**REDUCTION TABLE FOR USE WITH
ELECTRIC CURRENT METERS
PATTERNS Nos. 617, 618, 621 AND 623—Continued**

Time In Seconds	VELOCITY IN FEET PER SECOND						
	60 Revs.	70 Revs.	80 Revs.	90 Revs.	100 Revs.	150 Revs.	200 Revs.
40	3.34	3.90	4.45	5.01	5.56	8.34	11.12
41	3.26	3.81	4.34	4.89	5.43	8.14	10.85
42	3.18	3.72	4.24	4.77	5.30	7.95	10.59
43	3.11	3.63	4.14	4.66	5.18	7.77	10.34
44	3.04	3.55	4.04	4.55	5.06	7.59	10.10
45	2.97	3.47	3.95	4.45	4.95	7.42	9.87
46	2.90	3.39	3.87	4.35	4.84	7.26	9.65
47	2.84	3.32	3.79	4.26	4.74	7.11	9.45
48	2.78	3.25	3.71	4.17	4.64	6.96	9.25
49	2.72	3.18	3.63	4.09	4.54	6.81	9.06
50	2.67	3.12	3.56	4.01	4.45	6.67	8.89
51	2.62	3.06	3.49	3.93	4.36	6.54	8.72
52	2.57	3.00	3.42	3.85	4.28	6.42	8.56
53	2.52	2.94	3.36	3.78	4.20	6.30	8.40
54	2.47	2.88	3.30	3.71	4.12	6.18	8.24
55	2.43	2.83	3.24	3.64	4.05	6.07	8.09
56	2.39	2.78	3.18	3.58	3.98	5.96	7.95
57	2.35	2.73	3.12	3.52	3.91	5.86	7.81
58	2.31	2.68	3.07	3.46	3.84	5.76	7.68
59	2.27	2.63	3.02	3.40	3.77	5.66	7.55
60	2.23	2.59	2.97	3.34	3.71	5.56	7.42
61	2.19	2.55	2.92	3.29	3.65	5.47	7.30
62	2.16	2.51	2.87	3.24	3.59	5.38	7.18
63	2.13	2.47	2.82	3.19	3.53	5.30	7.07
64	2.10	2.43	2.77	3.14	3.48	5.22	6.96
65	2.07	2.39	2.73	3.09	3.43	5.14	6.85
66	2.04	2.35	2.69	3.04	3.38	5.06	6.75
67	2.01	2.32	2.65	2.99	3.33	4.98	6.65
68	1.98	2.29	2.61	2.95	3.28	4.91	6.55
69	1.95	2.26	2.57	2.91	3.23	4.84	6.45
70	1.92	2.23	2.53	2.87	3.18	4.77	6.36

W. & L. E. Gurley, Troy, N. Y.



No. 621
ELECTRIC CURRENT METER



No. 623

ELECTRIC CURRENT METER



No. 629

BOYDEN HOOK GAGE

This instrument, so called from the name of its inventor, is used in determining the depth of water flowing over weirs, etc.

As shown in the illustration, it has a frame of wood, three feet long and four inches wide, in a rectangular groove of which is made to slide another piece carrying a metallic scale, graduated in feet and hundredths, and figured from zero to two feet and two tenths.

Connected with the scale is a brass screw passing through a socket, fastened to another shorter sliding piece which can be clamped at any point on the frame, and the scale with hook moved in either direction by the milled head nut.

A vernier is also attached to the frame, movable under the screw heads which secure it, in order to adjust its zero to correspond with the point of the hook, as will be described hereafter. The vernier reads the scale to thousandths of a foot.

The hook is of brass and has a sharp point, which, when raised to the surface of the water at rest, indicates its precise level.

TO USE THE HOOK GAGE

The hook gage is used in a box attached to a flume at any convenient point near the weir, the water from the flume being conveyed to the box by rubber or lead pipes, thus indicating the precise level of the water in the flume, the surface of the water in the box being at rest.

When the depth of the water passing over a weir is required, the exact level of the crest of the weir should be taken by a leveling instrument and rod, and marked by a line drawn in the still water box at the surface of the water. The scale of the gage being previously set at zero with the vernier, the frame is fastened to the box above the water in such a position that the point of the hook is at the same level as the crest of the weir, the precise point being secured by the adjusting screw of the scale. See that the zeros of the scale and vernier are in line, and if not, move the vernier under the screw heads until the zeros correspond, and set the vernier fast. The point of the hook will, of course, be under water, and level with the crest of the weir.

The depth of water flowing over the weir is the distance between the point of the hook in the position named and the exact surface of the water. To ascertain this, the hook is raised by turning the milled head nut until the point of the hook, appearing a little above the surface, causes a distortion in the reflection of the light from the surface of the water. A slight movement of the hook in the opposite direction will cause the distortion to disappear, and will indicate the surface with precision. The reading of the scale will then give the depth of water passing over the weir, in thousandths of a foot.

It will be understood from the illustration that the longer movements of the scale are made by moving the clamping piece over the frame, the finer adjustments being effected by the milled nut.

We are prepared to make to order, from designs furnished, water registers, tide gages, and similar instruments.

TELESCOPIC HAND LEVELS



No. 640

No. 641

The illustrations represent instruments devised by us as an improvement upon the ordinary hand levels and calculated to increase their usefulness in the work of the engineer.

The Monocular Hand Level, shown in No. 640, consists of a tube to which are fitted the lenses of a single opera glass, and which also contains a reflecting prism, a cross wire, and a level vial, the latter being seen in the open part of the tube.

The eye lens, as indicated in the illustration, is composed of two separate pieces, the larger one being the usual concave eye lens of the opera glass, and the smaller a segment

of a plano convex lens having its focus on a cross wire under the level vial and above the reflecting prism.

The observer holds the tube horizontal with the level opening uppermost, and observes the object to which the instrument is directed, and the position of the level bubble with reference to the cross wire on the under side of the level vial.

When the hand level is held truly horizontal the cross wire will bisect the bubble, and will determine the level of any object seen through the telescope, thus securing to the observer a clear view of the object, magnified by the telescope.

The Binocular Hand Level, No. 641, consists of two tubes, the one on the right enclosing the usual lenses of the opera glass, and the tube on the left containing only the prism, level vial and cross wire of the instrument just described. This level is used like the ordinary opera glass, being held with the level vial above, as shown.

When the tubes are held truly horizontal, the engineer will see with one eye the cross wire bisecting the bubble, and with the other eye will see the object observed, the level line of which is determined by the position of the cross wire upon the surface of the level vial.

The Binocular Hand Level gives a clearer view of an object than is possible with a single tube, there being no light lost by the interference of the prism and the level vial.

The hand level is adjusted by sliding the prism tube back and forth, until the line given is the same as that given by a Y Level.

The prism in the tube can be reached by removing the cap from the closed end of the tube, and it is clamped by a small screw on the lower side.

LOCKE HAND LEVEL

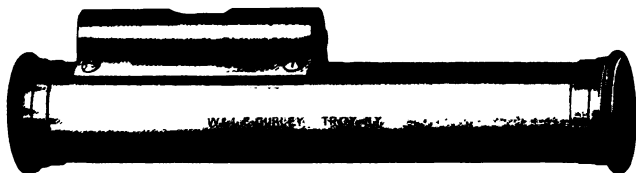

No. 643

This instrument consists of a brass tube about six inches long, having a level vial on top near the object end, as shown. There is an opening in the tube beneath, through which the bubble can be seen, as reflected by a prism immediately under the level vial. Both ends of the tube are closed by disks of plain glass to exclude dust, and there is at the inner end of the sliding or eye tube a semi-circular convex lens, which serves to magnify the level bubble and the cross wire beneath, while it allows the object to be clearly seen through the open half of the tube.

The cross wire is fastened to a frame moving under the level tube, and adjusted to its place by the small screw shown on the end of the level case. The level of any object in line with the eye of the observer is determined by sighting upon it through the tube, and bringing the bubble of the level into a position where it is bisected by the cross wire.

ABNEY LEVEL AND CLINOMETER

The Abney Level is a modification of the Locke Hand Level, combining with it an excellent clinometer.

The main tube being square, it can be applied to any surface, the inclination of which is ascertained by bringing the level bubble into the middle, and reading off the angle to five minutes by the arc and vernier. When sighted at an object and the bubble brought into the middle, the vertical angle from the height of the eye is indicated. When at zero it indicates a level line.

The inner and shorter arc indicates the lines of different degrees of slope, the left edge of the vernier plate being applied to the lines, and the bubble brought into the middle



No. 646

as usual. A small compass, with needle about one and one half inches long, is sometimes attached to the upper surface of the Abney Level, with a plain staff socket below.

CHAINS

THE sizes and diameters of iron and steel wire commonly used in making surveyors and engineers chains are as follows: No. 8, .162 inch; No. 10, .135 inch; No. 12, .105 inch; No. 15, .072 inch; No. 18, .047 inch.

The ordinary Gunter's or surveyors chain is sixty six feet or four poles long, and is composed of one hundred links, connected each to each by two rings, and furnished with a tally mark at the end of every ten links. A link in measurement includes a ring at each end, and is seven and ninety two one hundredths inches long. In all the chains which we make the rings are oval and are sawed and well closed, the ends of the wire forming the hook being also filed and bent close to the link, to avoid kinking. The oval rings are about one third stronger than round ones.

The handles are of brass and form part of the end links, to which they are connected by a short link and jam nuts, by which the length of the chain is adjusted.

The tallies are of brass, and have one, two, three or four notches, as they mark ten, twenty, thirty or forty links from either end. The fiftieth link is marked by a rounded tally to distinguish it from the others.

In place of the four pole chain just described, many surveyors prefer a chain two rods or thirty three feet long, having only fifty links, which are counted by tallies from one end in a single direction.

Our surveyors chains are made of Nos. 8 and 10 refined iron wire, and of Nos. 8, 10, 12 and 15 best steel wire. Steel chains are preferred on

account of their greater strength, although they are more expensive than those of iron.

Engineers Chains Engineers chains differ from surveyors chains, in that a link including a ring at each end is one foot long, and the wire is of steel Nos. 8, 10 and 12.

They are either fifty or one hundred feet long, and are furnished with swivel handles and tallies like those just described.

Brazed Steel Chains A very light and strong chain is made of No. 12 steel wire, the links and rings of which are securely brazed. The wire is of a low spring temper, and the chain, though light, is almost incapable of being broken or stretched in careful use.

Our brazed steel chains have been found exceedingly desirable for all kinds of measurement, and for the use of engineers upon railroads and canals have very generally superseded the heavier chains.

Steel Snaps We frequently make chains with steel snaps in the middle and at one handle. The chain can then be separated, and one handle being removed and transferred to the forty ninth link, a chain of half length is obtained. This modification is made without charge, if ordered with the chain.

To Use the Chain In using the chain the length must be taken from the extreme ends, and the marking pins placed on the outside of the handles. It must be drawn straight and taut, and carefully examined to detect any kinks or other causes of inaccuracy.

Standard Measure Chains Nos. 650 to 673 and 690 to 732 are carefully tested at every link and in their whole length, by the U. S. standard, with a strain of ten pounds and with temperature at 62° Fahrenheit; and when new they may always be relied upon as correct.

All chains will be more or less lengthened after long use in the field, and it will be best for the surveyor to lay down on a level surface the exact length of the chain when new, marking its extreme ends by monuments which will not be liable to disturbance. He will thus have a standard measure of his own to which the chain can be adjusted from time to time.

GRUMMAN'S PATENT CHAINS

These chains, invented and patented by J. M. Grumman, of Brooklyn, N. Y., are made of very light steel wire, the links being finely tempered, and, as shown in the illustration, so formed at the ends as to fold together readily, and thus dispense with the use of rings.

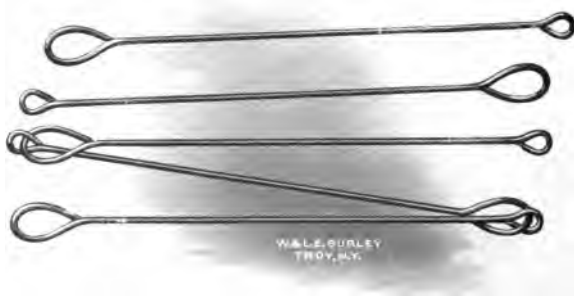

This construction gives but one third as many wearing points as are in the ordinary chain, and affords the utmost facility for repairs.

Five or ten extra links are furnished with each chain, and these have only to be sprung into place to replace any which

may have been broken. The chain can also be sprung apart at any link, and be made of any length desired.

Some of these chains are made of No. 15 wire, and are used for measuring on the surface, like the ordinary chain. One is used as a suspended chain for very accurate measurements, and is of No. 18 wire and provided with spring balance, level, and thermometer attachments. When in use it is held above the surface, and the extremities of the chain are marked upon the ground by the points of plummets let fall from fixed places on the chain. The Grumman chains are tested with a strain of six pounds.

VARA CHAINS

The vara, which is in general use in Texas, is 33.333 inches long. The chains are made both of iron and steel wire, ten or twenty varas in length, each vara being usually divided into five links. A link, including a ring at each end, is therefore 6.666 inches long. A ten vara chain has fifty links, a twenty vara chain one hundred links. Each vara is marked by a round brass tally, numbered from one to nine in the ten vara chain, and from one to nineteen in the twenty vara chain.

METER CHAINS

The meter is used as a standard measure of length in many countries, and chains of ten and twenty meters are often ordered. The chains are made of iron or steel wire, each meter being divided into five links. As a meter is 39.371 inches long, a link, including a ring at each end, measures 7.874 inches.

A ten meter chain has fifty links and a twenty meter chain one hundred links. Each meter is marked with a round brass tally numbered from one to nine in the ten meter chain, and from one to nineteen in the twenty meter chain.

MARKING PINS

In chaining, eleven marking pins are needed, made either of iron, steel or brass wire, as preferred. They are about fourteen inches long, pointed at one end to enter the ground, and formed into a ring at the other end for convenience in handling.

Marking pins are sometimes loaded with a little mass of lead around the lower end, to serve as a plumb when the pin is dropped to the ground from the suspended end of the chain.

CHAIN TAPES

Chain tapes are generally used on bridge, road and street work, and as standards for comparison of other chains and tapes. They are made of a thin ribbon of steel about one quarter of an inch wide, and of straight spring temper, and commonly in lengths of from thirty three to five hundred feet.



No. 760

The thirty three and sixty six feet lengths are usually graduated at each Gunter's link for use in land surveying, and the fifty and one hundred feet lengths are graduated at each foot, and also have the first and last foot marked in tenths, for city work.



No. 770

A convenient reel for tapes Nos. 760 to 767 is shown in the illustration of No. 760. When not in use, the handle of the drum can be folded flat, and a small projection at its base fits into a slot made to receive it, and thus clamps the drum and prevents the tape from unwinding.

The tapes from three hundred to five hundred feet in length are usually graduated at each five feet, with the first and last five feet marked at each foot. They are wound upon a substantial wooden reel with aluminum and brass mountings, as shown above.

Our chain tapes are U. S. standard measure at 62° Fahrenheit, and with ten pounds strain.

METALLIC TAPES

These are of linen, about five eighths of an inch wide, and have fine brass wires interwoven through their whole length. They are thus measurably correct, even when wet.

They are graduated in feet and tenths or in feet and inches, on one side, as ordered, and are marked in links on the reverse side. They are wound in a leather case having a folding handle.

STEEL TAPES

The best tapes are made of a thin ribbon of steel in one piece, of straight spring temper, and either one quarter, three eighths or one half inch wide.

They are made in all lengths from twenty five to two hundred feet, graduated to feet, inches, and eighths of an inch, or more usually feet, tenths and hundredths of a foot.

They are also graduated at each Gunter's link, on the reverse side if desired. The figures and graduations are etched on the surface of the steel.

American steel tapes (Paine's pattern) are made of thin steel ribbon in one piece, about one quarter of an inch wide and of straight spring temper. They can be detached from the case when desired, and used with a pair of handles for chain measurements. They can also be used with handles having a compensation scale for variations of temperature.

These tapes are U. S. standard measure at 62° Fahrenheit, with about twelve pounds strain. A hundred foot tape expands .0756 inch for each 10° rise in temperature.

The tapes are wound in a leather or metal case with folding handle.

The Excelsior steel tape is liked for use in mines. It is one half inch wide, and is mounted on an open brass frame, nickel plated, and with double folding flush handle. It is easily wound and unwound, and the open frame allows the evaporation of moisture.

METRIC AND VARA TAPES

We can furnish any of our metallic tapes, Nos. 780 to 794, and steel tapes, Nos. 820 to 835, with metric or vara measure on the reverse side instead of links at extra prices, as quoted on pages 346 and 349; and with metric or vara measure only, at prices of regular styles of the same length in feet.

Our extra heavy metric chain tapes, Nos. M25 to M100, are graduated with metric measure only, and are marked in decimeters, with the first meter in centimeters and the first decimeter in millimeters. If graduated with vara measure only, they are marked in tenths of a vara. See Nos. V20 to V100, page 345.



INFORMATION TO PURCHASERS

SELECTION OF INSTRUMENTS

THE PLAIN COMPASS will answer for original surveys, or for ascertaining the bearing of lines in the preparation of county maps.

The VERNIER COMPASS, or VERNIER TRANSIT COMPASS, will be required where allowance must be made for the magnetic declination, as in retracing the lines of an old survey.

When local attraction must be taken into account, in addition to the magnetic declination, and angles must be taken independently of the needle, an instrument with a graduated limb must be used, and for this purpose the RAILROAD COMPASS is suitable.

For a mixed practice of general surveying, including farm and city work, the establishment of grades and the running of levels, the SURVEYORS TRANSIT, with its various attachments, is sufficient.

The different forms of the ENGINEERS TRANSIT, the MOUNTAIN TRANSIT, and the Y LEVELING INSTRUMENTS are designed for engineering work of the highest class.

In the United States public land surveys, an instrument with solar attachment is required, and the SOLAR TRANSIT is usually selected.

In surveys of mining claims, especially in locations difficult of access, and for the survey of mines in general, the MOUNTAIN TRANSIT, with the solar and other attachments, has proved a universal favorite.

The various PLANE TABLES have a recognized utility for topographical work and map drawing.

The **CURRENT METERS** are almost indispensable in measuring the velocity of the flow of water in harbors, rivers, small streams and irrigation ditches.

The **DRAINAGE LEVEL** is the simplest and most efficient instrument designed for laying out drains and similar work.

The **ARCHITECTS LEVEL** and the **BUILDERS TRANSIT** are used in laying out buildings, determining the level of their floors, sills and windows, and in the general work of the builder.

The **EXPLORERS TRANSIT**, the **RECONNOISSANCE TRANSIT** and the various forms of **POCKET COMPASSES**, with or without telescopic attachment, are desirable for a large class of work where extreme lightness and portability are essential.

Where iron ores are to be traced, the **MINERS DIP COMPASS**, the **DIAL COMPASS** and the **POCKET SOLAR COMPASS** are used. We do not make any instrument by which veins of gold and silver can be traced, or the presence of these metals detected.

LOW PRICE OF OUR INSTRUMENTS

It is often stated that it is impossible to make first class instruments at our prices, which are lower than those of other skilled manufacturers. A visit to our factory, and a comparison of our facilities with those of any other manufacturer will dispel all doubts as to our ability to furnish the best instruments for the money that can be produced in this country.

Our instruments are not carried in stock by merchants, and we do not deem it advisable to add to our prices in order to give to merchants a large discount, which, of course, would be paid by the purchaser.

TERMS OF PAYMENT

Our terms of payment are uniformly cash, and we have but one price, whether ordered in person or by mail or telegraph.

Remittances may be made by a cashier's draft payable to our order, which can be procured from banks or bankers in almost all the larger villages, or by express company or post office money orders. These may be sent by mail with the order for the instrument, and if lost or stolen on the way can be replaced by a duplicate obtained as before, without additional cost. The customer may also send the money in advance by registered mail or by the express agent, or may pay the agent on receipt of the instrument in funds current in New York.

The cost of returning the money on bills amounting to less than \$20, collected by express, will be charged to the customer.

When articles are to be sent by mail payment must be made in advance, including the cost of postage. The postage required is stated in the second column of the Price List.

Customers ordering instruments and desiring changes in construction from our regular patterns must make a payment in advance, with the order, of fifty per cent of the price.

WARRANTY

All of our instruments are critically tested before shipment, and are sent to the purchaser adjusted and ready for immediate use.

When purchased directly from us they are warranted correct in all their parts, we agreeing, in the event of any

original defect appearing after reasonable use, to repair or replace with a new and perfect instrument, promptly, and at our own cost, express charges included; or we will refund the money and the express charges paid by the customer.

It sometimes happens, in a business as large and widely extended as ours, that instruments reach our customers in bad condition, owing to careless transportation or to defects escaping the closest scrutiny of the maker. We consider the retention of such instruments by the purchaser an injury very much greater to us than to himself.

TRIAL OF INSTRUMENTS

This statement may be read by those who are entirely unacquainted with us or the quality of our work, and who therefore feel unwilling to purchase an instrument, of the excellence of which they are not perfectly assured.

To such persons we make the following proposition: If requested to do so, we will send the instrument to the express station nearest the purchaser, and direct the express agent to collect our bill on delivery, together with charges for transportation, and hold the money on deposit three days, if desired, until the purchaser shall have had an actual trial of the instrument.

If the instrument is not found as represented, the purchaser may return it before the expiration of the specified time, and receive in full the money paid the agent, including express charges, and direct the instrument to be returned to us.

This privilege of trial applies only to our larger transits, levels, and compasses, is not given unless requested, and is allowed only in the United States.

EXTENT OF OUR PLANT

For many years our facilities for manufacturing have been far superior to those of any other similar establishment in the world, and they are being constantly increased by the introduction of new machinery and tools.

We now make under our own roof the lenses for the telescopes of our instruments, the glass vials for the level tubes, the wooden boxes in which the instruments are packed, and the leather cases and straps for these boxes, as well as all the metal parts of the instruments themselves.

FINISH OF INSTRUMENTS

All instruments are covered with a lacquer applied while the work is heated. As long as this lacquer remains the brass surface will not tarnish, and the engineer can preserve its original freshness for a long time by taking care not to rub the instrument with a dusty cloth or expose it to the friction of his clothes.

Instead of the brass finish, most engineers prefer instruments blackened or bronzed. This is done with an acid preparation, after the work has been polished, and gives the instrument a very showy appearance. It is also advantageous because it does not reflect the rays of the sun as much as the bright or brass finish.

If no special direction is given, we usually send transits, levels and solar instruments with bronze finish, and compasses with bright finish.

ALUMINUM

Since 1876 we have made civil engineers and surveyors instruments of aluminum, to order only. The sole advantage

which instruments of aluminum have over those of the ordinary metals is their light weight; but as all the bearing parts must be made of bronze, the total weight can be reduced only about fifty per cent. We finish our aluminum instruments in the natural color, and the result is more satisfactory than when an artificial coloring is used, although it entails much extra expense. We will quote prices on application for any of our instruments of regular pattern made of aluminum.

PACKING

Each of our transits, levels, and surveyors compasses is packed in a well finished mahogany box, furnished with lock and key and brass hooks, and leather strap for convenience in carrying. Each case is provided with screw driver, adjusting pin and wrench for center pin, and, if accompanied by a tripod, with a brass plummet. With all the instruments used for taking angles without the needle, a reading glass is also furnished.

Unless the purchaser is already supplied, each instrument is accompanied by our Manual, giving full instruction for such adjustments and repairs as are possible to one not provided with the facilities of an instrument maker.

When sent to the purchaser, the mahogany boxes are enclosed in outside packing cases of pine, made a little larger on all sides to allow the use of elastic material. So effectually are our instruments protected by these precautions, that of very many thousands sent out since 1845, in all seasons and by every mode of transportation, and to all parts of the world, very few have sustained any serious injury.

Instruments packed for foreign shipment, which are to have ocean passage, are wrapped in waterproof material.

MEANS OF TRANSPORTATION

Instruments can be sent by express to almost every town in the United States, Canada and Mexico, agents being located at all the more important points, by whom they are forwarded to smaller places by stage.

Charges for transportation are in all cases to be borne by the purchaser, we guaranteeing the safe arrival of our instruments at his express office, and holding the express company responsible for loss and damage on the way.

INSTRUMENTS FOR FOREIGN COUNTRIES

We send civil engineers and surveyors instruments to Canada, Mexico, Central America, Cuba, South America, China, Japan, Australia, Africa, and India, as well as to various parts of Europe.

In every case, the cash for orders for foreign shipments by steamship must accompany the order. If it is desired that we attend to the shipment of the instruments, the remittance must be made ten per cent. more than the catalogue price of the instruments if the order amounts to \$250 or less; eight per cent. more than the catalogue price if the order amounts to from \$300 to \$500; or six per cent. more than the catalogue price if the order amounts to from \$600 to \$1,000. The extra remittance is to cover the cost of shipping charges, freight and insurance, which must always be paid in advance on all shipments except those to Canada and some parts of Mexico.

If the amount remitted is more than sufficient to cover these expenses, any balance will be returned to the purchaser with the receipted bill and bill of lading, unless we are directed to hold it to his credit and subject to his order.

Remittances must be made by bankers draft on London, England, or on New York city, and such drafts can be purchased in any of the large cities of the countries named above.

When telegraphing cable messages to us, use either the Western Union, the Lieber or the A B C, fifth edition, codes.

REPAIR OF INSTRUMENTS

We receive every year hundreds of instruments of our own and other makes, sent to us for refitting and repairs. Most of these have been injured by falls, many have parts worn and defective after long use, and others are sent for repolishing and renovating.

The injuries are usually more serious than is apparent, and their full extent can be ascertained only by an examination as the instrument is taken apart.

We advise our customers who have instruments in need of repairs to send them directly to us, as our facilities enable us to do the work much more economically and promptly than any other maker, however accessible.

The instruments should always, when practicable, be placed in their own boxes, and then enclosed in an outside packing case, an inch larger in all its dimensions, that the space between the two may be filled with paper wadding, hay or fine shavings. THE OWNERS NAME AND ADDRESS should always appear on the package, and a note specifying the repairs needed should always accompany the instrument, and a letter should also be sent to us by mail, giving not only directions as to the repairs, but also stating when the return of the instrument is desired and the address to which it is to be forwarded.

Each instrument is made to fit its own spindle, and no other; and therefore this part, with the leveling head, if it

has one, should always be sent with the instrument. The tripod legs and the head in which they are inserted need not be sent, unless themselves in need of repairs.

When requested to do so, we will send an estimate of the cost of repairs to any instrument sent us, before beginning the work.

Compasses come to us with the plates sprung, the sights bent or broken, the glass or level vials fractured, and the pivot so dulled as to render the needle sluggish and unreliable.

The cost of repairing these defects ranges from \$2 to \$10. A pair of new sights, fitted, costs \$5; a new needle with jeweled center and pivot complete, \$3; a new jeweled center only, \$1.50; regraduating the compass circle, \$5. In case of any trouble with the needle it is always best to send the needle and center pin to us by mail, with \$3.12, and we will then either repair and return the parts, with any balance due the owner, or we can send new needle and center pin complete, by registered mail, postpaid. We are in daily receipt of compass needles sent to us for repairs from all parts of the country.

A compass sent for repairs must always be accompanied by the ball spindle; and if a new ball spindle is required, the whole instrument, or at least the socket in which the spindle fits, should be forwarded to us. A new ball spindle, fitted, costs \$3. See also page 306.

Repairs to Railroad Compasses cost from \$10 to \$20, and to Solar Compasses from \$20 to \$50. Regraduating the horizontal limb and vernier to read to one minute, costs \$10.

Repairs to Transits The injuries which Engineers and Surveyors Transits sustain by falls are usually much more serious. The plates, standards and axes of telescopes

are often bent, and sockets or centers are generally so damaged as to be entirely useless.

The cost of repairing an instrument with such injuries ranges from \$10 to \$30 or even \$50, new sockets alone costing from \$15 to \$20. See also page 306.

Variation plate added to an Engineers Transit sent for repairs, costs	\$15.00
Regraduating horizontal limb and vernier to read to one minute, costs	10.00
Regraduating vertical limb and vernier to read to one minute, costs	5.00

No one but a skilled workman provided with the best facilities can properly set the platinum wires in a cross wire

Platinum, diaphragm, and it is, therefore, useless for Cross Wires us to send a parcel of wires for that purpose. The only way in which they can be replaced without sending the telescope to us is to take out the ring and send it, with its screws, washers, etc., and we will return it with the wires properly secured.

Plain platinum cross wires, replaced on the old ring, cost	\$2.00
Adjustable platinum stadia wires and cross wires, replaced on the old ring, cost	3.00
Fixed platinum stadia wires and cross wires, replaced on the old ring, cost	5.00

If to be sent by mail, add 15 cents for postage and registry, and 25 cents for a safety brass packing box.

We are not responsible for wires sent in this way and broken while inserting the ring in the telescope. The best plan is to send us the telescope when new cross wires are needed.

When it is desirable to substitute platinum for spider web, a new ring with screws will be required, and the telescope should be sent to us.

Plain platinum cross wires, with diaphragm, screws, etc., cost	\$3.00
Adjustable platinum stadia wires, with diaphragm, screws, etc., cost	5.00
Fixed platinum stadia wires, with diaphragm, screws, etc., cost	7.00

See also pages 19 to 23

Leveling instruments are generally much less injured by
Repairs to falls than transits. The damages usually con-
Levels sist in the bending of the bar, the springing of
the sockets, and the breaking of the vial.

The cost of repairs varies from \$5 to \$20. A new level
vial set in the old tube costs \$1.25 to \$2.50, according to
the size of the level. See also page 307.

Repolishing The cost of repolishing an instrument varies,
Instruments but may be stated generally as follows:

COMPASSES, Plain and Vernier	\$ 5.00 to \$ 7.00
RAILROAD COMPASSES	8.00 to 10.00
SOLAR COMPASSES, large size	12.00 to 15.00
TRANSITS	12.00 to 15.00
Y LEVELS	8.00 to 12.00

These prices are in addition to the cost of adjustment and
of any necessary repairs. No additional charge is made for
bronzing or blackening an instrument when repolished.

Payment where the instrument is received, the customer
paying in advance for the transportation of the
instrument to us or not, as he may prefer. Whenever the
charges are paid in advance, the express receipt should be
mailed directly to us.

**PRICES FOR PARTS OF INSTRUMENTS
LIABLE TO LOSS OR INJURY**

FOR TRANSITS

	PRICE	POST
Needle with jeweled center and center pin	\$3.00	\$0.12
Center pin only50	.01
Ground glass level vial for plate or standard, each45	.02
Ground glass level vial, brass mounted complete, for plate or standard, each	2.00	.14
Ground glass level vial for telescope	1.25	.14
Cap for eyepiece or objective, each75	.03
Shade for objective75	.03
Clamp screw for horizontal limb75	.02
Tangent screw for leveling head75 to 1.50	.13
Clamp screw for leveling head75	.03
Leveling screw for leveling head	1.00 to 1.50	.14
Eyepiece complete	6.00	.14
Objective complete	6.00	.14
Platinum cross wires and diaphragm	3.00	.15
Platinum stadia wires, adjustable, and diaphragm	5.00	.15
Platinum stadia wires, fixed, and diaphragm	7.00	.15
Mahogany box with lock and strap, fitted inside, 5.00 to 6.00		

FOR SURVEYORS COMPASSES

Needle with jeweled center and center pin	\$3.00	\$0.12
Center pin only50	.01
Ground glass level vials, each35	.02
Ground glass level vials, brass mounted complete, each	2.00	.14
Brass cover for Compass of our make	1.00	.25
Outkeeper	1.00	.13
Glass circle for compass face25	.15
Wrench for center pin10	.01
Staff mountings, brass head, without spindle	2.00	.25
Staff mountings, steel point50	.18
Ball spindle, fitted to old socket	3.00	.30
Compass sight vanes, each	2.50	.20
Clamp screw for spindle or sight vane50	.03
Tangent screw for moving vernier	1.50	.12
Staff mountings complete for Pocket Compass, small	2.50	.15
Staff mountings complete for Pocket Compass, large	3.50	.20
Mahogany box with lock and strap, fitted inside	4.00 to 6.00	

PRICES FOR PARTS OF INSTRUMENTS

FOR Y LEVELS

	PRICE	POST
Ground glass level vial, unmounted, for 22 inch Y Level	\$1.85	\$0.20
Ground glass level vial, unmounted, for 15-20 inch Y Levels	1.65	.18
Ground glass level vial, extra sensitive (ten seconds in one tenth of one inch), unmounted, for 18, 20, or 22 inch Y Levels	4.00	.15
Ground glass level vial, unmounted, for Architects Level	.90	.05
Cap for eyepiece or objective, each	.75	.03
Clamp screw for leveling head	.75	.08
Tangent screw for leveling head	75 to 1.50	.13
Leveling screw for leveling head, each	1.00 to 1.50	.14
Eyepiece complete	6.00	.14
Objective complete	7.00	.14
Platinum cross wires and diaphragm	3.00	.15
Platinum stadia wires, adjustable, and diaphragm	5.00	.15
Platinum stadia wires, fixed, and diaphragm	7.00	.15
Mahogany box, with lock and strap, fitted inside	4.50 to 6.00	

MISCELLANEOUS

Plain tripod legs only, for Engineers Transit or Level, per set	\$5.00	
Split tripod legs only, for Engineers Transit or Level, per set	7.00	
Extension tripod legs only, for Engineers Transit or Level, per set	10.00	
Clamp screw and band for extension leg, each	.85	\$0.05
Tripod head only, with bolts and nuts, for Engineers Transit or Level	5.00	.50
Wooden cap with brass screw plate, to fit tripod head	.75	.12
Brass bolt and nut to fit tripod head, each	.75	.05
Brass bolt and nut to fit tripod head, per set of three	1.50	.15
Metal point or shoe for tripod leg, each	.50	.05
Leather ring to bind tripod legs together	.10	.02
Leather strap and buckle for Transit or Level Box	.50	.15
Leather strap and handle for carrying extension tripod	.50	.10
Steel screw driver with wooden handle	.25	.05
Steel adjusting pins, each	.05	.01
Rubber tips, for bottom of instrument box, per set	.40	.08
Reading glass, for Transit	.75	.02
Brass Plummet with screw cap, for Transit or Level	1.50	.20
Waterproof hood, for Transit or Level	1.00	.06
Chamois skin, large size, best quality	.65	.05
Clamp with scale and clamp screw, for New York rod	3.00	.15
Clamp with scale and clamp screw, for Philadelphia rod	3.00	.15
Target with clamp screw and spring, for New York or Philadelphia rod	4.50	.35
Chain handle, with staple and nuts, each	.75	.01
Chain tallies, per set of 9	.50	

SPECIAL NOTICE

A Transit with plain telescope is one without any attachments or extras, such as the clamp and tangent, vertical circle and level.

The telescopes of our Transits Nos. 1 to 17, 25 to 90 and 110 to 117 are furnished with rack and pinion movement to both eyepiece and objective, without extra charge.

In Transits Nos. 20 to 22, 100, 102 and 105, the objective is focused by a rack and pinion and the eyepiece by a spiral movement.

The telescopes used on all our Transits, can be focused on an object as near as four and one half feet from the center of the instrument.

Our Transits Nos. 1 to 105 are furnished with shifting center to the leveling head, and with a tripod and leveling screws, and clamp and tangent to spindle. Transits Nos. 20 to 22, 25 to 31, 100 and 102, have tripods with extension legs. For prices of plain, split leg and extension tripods see page 327.

The limbs of our Transits Nos. 1 to 102 are graduated on sterling silver. The graduation is usually to half degrees, and is read by vernier to single minutes. A finer graduation is furnished, if desired, at an extra cost. See pages 28 to 31 and page 319.

The vertical circles and vertical arcs are graduated on sterling silver. The circle of $3\frac{1}{2}$ inches diameter is graduated, to degrees, and is read by vernier to 5 minutes. The circles of $4\frac{1}{2}$ and 5 inches diameter and the arc of $2\frac{1}{2}$ inches radius are graduated to half degrees, and are read by vernier

to 1 minute. The arc of 3 inches radius is graduated to 20 minutes and is read by vernier to 30 seconds.

A variation arc furnished with a new Engineers Transit, No. 1 to 16, costs extra \$4. See No. 130, page 319.

Our Transits Nos. 17 to 102 and 110 to 117 have a variation arc for setting off the magnetic declination.

A leveling head with plates, leveling screws and clamp and tangent movement, fitted to Vernier Transits, costs extra \$18.00. See No. 176, pages 162 and 320.

Unless otherwise ordered, platinum stadia wires are always furnished with all Mountain Transits, with all Solar Transits, and with the Reconnaissance Transits.

Stadia wires are furnished without extra charge if requested when ordering any new Transit. When desired, we arrange the stadia wires to disappear, or be out of focus, when the plain cross wires only are in use. See pages 23 and 304 to 305.

A dust guard to the objective slide is furnished without charge with new Transits Nos. 1 to 90 and 110 to 117; but if furnished with new Transits Nos. 100, 102, or 105, the extra cost is \$4. See pages 24 and 320.

Reflectors to the limb verniers are always furnished with Mountain Transits Nos. 25 to 31, and are also furnished without charge, if requested, with new Transits Nos. 1 to 22 and 35 to 90; but if furnished with a new Transit No. 100 to 102, the extra cost is \$1.50.

Each Transit is packed in a mahogany case, with lock and leather strap, and has a plummet, reading glass, adjusting pins, etc. The wood box for the Explorers Transit is leather covered. The box for the Mountain Transit has an outside sole leather case with shoulder straps.

PRICE LIST
OF
CIVIL ENGINEERS
AND
SURVEYORS INSTRUMENTS
AND
SUPPLIES

PRICE LIST

FORTY SIXTH EDITION

TROY, N. Y., U. S. A., May, 1912

All Prices in this Book are in U. S. Currency. State which Edition of Manual when ordering, and give Catalogue Number

This Price List supersedes all previous Editions

ENGINEERS TRANSITS

WITH TWO VERNIERS TO LIMB

No.		PRICE
1	Engineers Transit, 4 inch needle, plain telescope and plain tripod	\$145.00
2	Engineers Transit, 4 inch needle, with level on telescope and clamp and tangent to telescope axis	163.00
3	Engineers Transit, 4 inch needle, with 4½ inch vertical circle, level on telescope and clamp and tangent to telescope axis	175.00
4	Engineers Transit, 4 inch needle, with vertical arc of 3 inches radius, and vernier moved by tangent screw, level on telescope and clamp and tangent to telescope axis	181.00
5	Engineers Transit, 4 inch needle, with vertical arc of 3 inches radius and vernier moved by tangent screw, level on telescope, and gradienter combined with clamp and tangent to telescope axis	193.00
6	Engineers Transit, 4½ inch needle, plain telescope and plain tripod	150.00
7	Engineers Transit, 4½ inch needle, with level on telescope and clamp and tangent to telescope axis	168.00
8	Engineers Transit, 4½ inch needle, with 4½ inch vertical circle, level on telescope and clamp and tangent to telescope axis	180.00
9	Engineers Transit, 4½ inch needle, with vertical arc of 3 inches radius and vernier moved by tangent screw, level on telescope and clamp and tangent to telescope axis	186.00

ENGINEERS TRANSITS

WITH TWO VERNIERS TO LIMB

No.		PRICE
10	Engineers Transit, $4\frac{1}{2}$ inch needle, with vertical arc of 3 inches radius and vernier moved by tangent screw, level on telescope and gradienter combined with clamp and tangent to telescope axis	\$198.00
	Engineers Transits Nos. 1 to 17 are regularly supplied with plain tripods No. 400 as shown on page 224. Split leg tripod No. 405 will be substituted, if preferred, for \$2.00 extra, or extension leg tripod No. 410 for \$5.00 extra. See pages 227 and 228.	
12	Engineers Transit, 5 inch needle, plain telescope and plain tripod, as shown on page 21	150.00
13	Engineers Transit, 5 inch needle, with level on telescope and clamp and tangent to telescope axis	168.00
14	Engineers Transit, 5 inch needle, with $4\frac{1}{2}$ inch vertical circle, level on telescope and clamp and tangent to telescope axis, as shown on page 35	180.00
15	Engineers Transit, 5 inch needle, with vertical arc of 3 inches radius and vernier moved by tangent screw, level on telescope and clamp and tangent to telescope axis	186.00
16	Engineers Transit, 5 inch needle, with vertical arc of 3 inches radius and vernier moved by tangent screw, level on telescope and gradienter combined with clamp and tangent, as shown on page 44	198.00
17	Engineers Transit, 5 inch needle, with variation arc, stadia, Solar Attachment, latitude level, vertical arc of 3 inches radius and vernier moved by tangent screw, level on telescope, and clamp and tangent to telescope axis, as shown on page 46	250.00

EXPLORERS TRANSITS

WITH TWO VERNIERS TO LIMB

No.		PRICE
20	Explorers Transit, $2\frac{3}{4}$ inch needle, with variation arc, stadia, 4 inch vertical circle, level on telescope and clamp and tangent to telescope axis, extension tripod with jointed legs and canvas case. Instrument packed in a mahogany case with leather cover and shoulder strap. See page 49.	\$165.00
21	Explorers Transit, with vertical arc of 2 inches radius and vernier moved by tangent screw, level on telescope and clamp and tangent to telescope axis	171.00
22	Explorers Transit, with vertical arc of 2 inches radius and vernier moved by tangent screw, level on telescope and gradienter combined with clamp and tangent to telescope axis	183.00

EXPLORERS TRANSITS

WITH TWO VERNIERS TO LIMB

No.		PRICE
23	Explorers Transit with Solar Attachment, latitude level, vertical arc of 2 inches radius and vernier moved by tangent screw, level on telescope and clamp and tangent to telescope axis	\$231.00
24	Leather dress suit case, 24 inches long, to contain Explorers Transit and jointed extension tripod, as shown on page 51	8.00

Regular extension tripods, without joints or canvas case, will be furnished, if desired, with Explorers Transits for \$5.00 less than the prices quoted above, but owing to their length, 38 inches when closed, they cannot be packed in a suit case.

LIGHT MOUNTAIN TRANSITS

WITH TWO VERNIERS TO LIMB

No.		PRICE
25	Light Mountain Transit, 4 inch needle, with variation arc, telescope of finest quality, power 20 diameters, stadia, and extension tripod shortening to half length. The instrument packed in a mahogany box, covered with a light sole leather case, with straps for packing. With plain telescope.	\$150.00
26	Light Mountain Transit, with level on telescope and clamp and tangent to telescope axis	168.00
27	Light Mountain Transit, with 4½ inch vertical circle, level on telescope and clamp and tangent to telescope axis. See page 52	180.00
28	Light Mountain Transit, with vertical arc of 2½ inches radius and vernier moved by tangent screw, level on telescope and clamp and tangent to telescope axis	186.00
29	Light Mountain Transit, with vertical arc of 2½ inches radius and vernier moved by tangent screw, level on telescope and gradienter combined with clamp and tangent to telescope axis	198.00
30	Light Mountain Transit, with Solar Attachment, latitude level, vertical arc of 2½ inches radius and vernier moved by tangent screw, level on telescope and clamp and tangent to telescope axis, as shown on page 55	245.00
31	Light Mountain Transit, with Solar Attachment, Jones latitude arc complete, level on telescope and clamp and tangent to telescope axis. See page 122.	300.00
32	Light Mountain Transit, with Telescopic Solar Attachment, vertical arc of 2½ inches radius and vernier moved by tangent screw, level on telescope and clamp and tangent to telescope axis. See page 116.	296.00

SURVEYORS TRANSITS

WITH TWO VERNIERS TO LIMB

No.		Price
35	Surveyors Transit, 4 inch needle, plain telescope and plain tripod	\$125.00
36	Surveyors Transit, 4 inch needle, with level on telescope and clamp and tangent to telescope axis	148.00
37	Surveyors Transit, 4 inch needle, with $4\frac{1}{2}$ inch vertical circle, level on telescope and clamp and tangent to telescope axis	155.00
38	Surveyors Transit, 4 inch needle, with $4\frac{1}{2}$ inch vertical circle, level on telescope and gradienter combined with clamp and tangent to telescope axis	167.00
39	Surveyors Transit, 4 inch needle, with vertical arc of 3 inches radius and vernier moved by tangent screw, level on telescope and clamp and tangent to telescope axis	161.00
40	Surveyors Transit, 4 inch needle, with vertical arc of 3 inches radius and vernier moved by tangent screw, level on telescope and gradienter combined with clamp and tangent to telescope axis	173.00
45	Surveyors Transit, 5 inch needle, plain telescope and plain tripod	130.00
46	Surveyors Transit, 5 inch needle, with level on telescope and clamp and tangent to telescope axis	148.00
47	Surveyors Transit, 5 inch needle, with $4\frac{1}{2}$ inch vertical circle, level on telescope and clamp and tangent to telescope axis, as shown on page 59	160.00
48	Surveyors Transit, 5 inch needle, with $4\frac{1}{2}$ inch vertical circle, level on telescope and gradienter combined with clamp and tangent to telescope axis	172.00
49	Surveyors Transit, 5 inch needle, with vertical arc of 3 inches radius and vernier moved by tangent screw, level on telescope and clamp and tangent to telescope axis	166.00
50	Surveyors Transit, 5 inch needle, with vertical arc of 3 inches radius and vernier moved by tangent screw, level on telescope and gradienter combined with clamp and tangent to telescope axis	178.00
55	Surveyors Transit, same as No. 45, but with $5\frac{1}{2}$ inch needle	130.00
56	Surveyors Transit, same as No. 46, but with $5\frac{1}{2}$ inch needle	148.00
57	Surveyors Transit, same as No. 47, but with $5\frac{1}{2}$ inch needle	160.00

SURVEYORS TRANSITS

WITH TWO VERNIERS TO LIMB

No.		PRICE
58	Surveyors Transit, same as No. 48, but with $5\frac{1}{2}$ inch needle	\$172.00
60	Surveyors Transit, 5 inch needle, with Solar Attachment, latitude level, stadia, vertical arc of 3 inches radius and vernier moved by tangent screw, level on telescope and clamp and tangent to telescope axis, as shown on page 67.	226.00

Surveyors Transits Nos. 35 to 60 are regularly equipped with plain tripods. Split leg tripods may be substituted for \$2.00 extra, or extension leg tripods for \$5.00 extra. See pages 227 and 228.

SURVEYORS TRANSITS

WITH ONE VERNIER TO LIMB

No.		PRICE
65	Surveyors Transit, 4 inch needle, plain telescope and plain tripod	\$110.00
66	Surveyors Transit, 4 inch needle, with level on telescope and clamp and tangent to telescope axis	128.00
67	Surveyors Transit, 4 inch needle, with $4\frac{1}{2}$ inch vertical circle, level on telescope and clamp and tangent to telescope axis.	140.00
68	Surveyors Transit, 4 inch needle, with $4\frac{1}{2}$ inch vertical circle, level on telescope and gradienter combined with clamp and tangent to telescope axis.	152.00
69	Surveyors Transit, 4 inch needle, with vertical arc of 3 inches radius and vernier moved by tangent screw, level on telescope and clamp and tangent to telescope axis	146.00
70	Surveyors Transit, 4 inch needle, with vertical arc of 3 inches radius and vernier moved by tangent screw, level on telescope and gradienter combined with clamp and tangent to telescope axis	158.00
75	Surveyors Transit, 5 inch needle, plain telescope and plain tripod	115.00
76	Surveyors Transit, 5 inch needle, with level on telescope and clamp and tangent to telescope axis, as shown on page 63.	133.00
77	Surveyors Transit, 5 inch needle, with $4\frac{1}{2}$ inch vertical circle, level on telescope and clamp and tangent to telescope axis.	145.00

SURVEYORS TRANSITS

WITH ONE VERNIER TO LIMB

No.		PRICE
78	Surveyors Transit, 5 inch needle, with 4½ inch vertical circle, level on telescope and gradienter combined with clamp and tangent to telescope axis	\$157.00
79	Surveyors Transit, 5 inch needle, with vertical arc of 3 inches radius and vernier moved by tangent screw, level on telescope and clamp and tangent to telescope axis	151.00
80	Surveyors Transit, 5 inch needle, with vertical arc of 3 inches radius and vernier moved by tangent screw, level on telescope and gradienter combined with clamp and tangent, to telescope axis	163.00
85	Surveyors Transit, same as No. 75, but with 5½ inch needle	115.00
86	Surveyors Transit, same as No. 76, but with 5½ inch needle	133.00
87	Surveyors Transit, same as No. 77, but with 5½ inch needle	145.00
88	Surveyors Transit, same as No. 78, but with 5½ inch needle	157.00
90	Surveyors Transit, 5 inch needle, with Solar Attachment, latitude level, stadia, vertical arc of 3 inches radius and vernier moved by tangent screw, level on telescope and clamp and tangent to telescope axis	211.00

Surveyors Transits Nos. 65 to 90 are regularly equipped with plain tripods. Split leg tripods may be substituted for \$2.00 extra, or extension leg tripods for \$5.00 extra. See pages 227 and 228.

RECONNOISSANCE TRANSITS

WITH ONE VERNIER TO LIMB

No.		PRICE
100	Reconnaissance Transit, 3½ inch needle, with 3½ inch vertical circle, level on telescope and clamp and tangent to telescope axis, stadia, leveling screws, and clamp and tangent to spindle, and extension tripod, as shown on page 69	\$115.00
102	Reconnaissance Transit, same as No. 100, but with 4½ inch vertical circle with vernier reading to one minute	122.00

BUILDERS TRANSIT

No.		PRICE
105	Builders Transit, with level on telescope, clamp and tangent to telescope axis and to limb and spindle, and with leveling screws and plain tripod, as shown on page 73	\$80.00

VERNIER TRANSIT COMPASSES

No.		PRICE
110	Vernier Transit, 5 inch needle, plain telescope, compass tripod	\$72.00
111	Vernier Transit, 5 inch needle, with level on telescope and clamp and tangent to telescope axis	90.00
112	Vernier Transit, 5 inch needle, with 3½ inch vertical circle, level on telescope and clamp and tangent to telescope axis	98.00
113	Vernier Transit, 5 inch needle, with 3½ inch vertical circle, level on telescope and clamp and tangent to telescope axis, leveling head and plain tripod	116.00
115	Vernier Transit, 6 inch needle, plain telescope, compass tripod	77.00
116	Vernier Transit, 6 inch needle, with level on telescope and clamp and tangent to telescope axis	95.00
117	Vernier Transit, 6 inch needle, with 3½ inch vertical circle, level on telescope and clamp and tangent to telescope axis	103.00
118	Vernier Transit, 6 inch needle, with 3½ inch vertical circle, level on telescope and clamp and tangent to telescope axis, leveling head and plain tripod. See page 77	121.00

ATTACHMENTS AND EXTRAS FOR TRANSITS

No.		PRICE	POST
130	Variation Arc added to a new Engineers Transit, Nos. 1 to 16, if ordered with the Transit	\$4.00	
131	Variation Arc added to Transits when sent for repairs	15.00	
135A	Vertical Circle, 3½ inches diameter, with vernier to 5 minutes. See pages 80 to 82	8.00	\$0.17
135B	Vertical Circle, 4 inches diameter, with vernier to 1 minute	12.00	.20
136	Vertical Circle, 4½ inches diameter, with vernier to 1 minute. See page 80	12.00	.20
137	Vertical Circle, 5 inches diameter, with vernier to 1 minute	15.00	.20
138	Vertical Circle, 5 inches diameter, with two opposite double verniers to 1 minute. See page 81	35.00	.35

ATTACHMENTS AND EXTRAS FOR TRANSITS

No.		Price	Post
139A	Vertical Arc, 2 inches radius, with vernier to 1 minute moved by tangent screw	\$18.00	\$0.20
139B	Vertical Arc, 2½ inches radius, with vernier to 1 minute moved by tangent screw. See page 83	18.00	.20
140	Vertical Arc, 3 inches radius, with vernier to 30 seconds moved by tangent screw. See page 83	18.00	.20
141	Aluminum Guard for Vertical Circle. See page 82	6.00	
145	Level on Telescope with ground vial and scale. See page 84	12.00	.25
146	Level on Telescope with reversion vial	17.00	.35
148	Clamp and tangent to telescope axis. See page 84	6.00	.15
149	Beaman Stadia Arc attached to new Transit. See page 87	15.00	
150	Gradienter combined with clamp and tangent. See page 89	18.00	.25
151	Platinum Stadia wires, adjustable, and diaphragm	5.00	.17
152	Platinum Stadia wires, fixed and diaphragm	7.00	.17
154	Dust Guard to objective slide. See page 25	4.00	
155	Rack and Pinion movement to eyepiece	5.00	
157	Sights on Telescope with folding joints. See page 86	8.00	
158	Sights on Standards at right angles with telescope. See page 86	8.00	
160	Detachable Side Telescope and Counterpoise for vertical sighting. See page 91.	25.00	.50
161	Detachable Riding Telescope, for vertical sighting. See page 91	25.00	.50
165	Reflector for illuminating cross wires. See page 93	4.00	.16
166	Reflector for illuminating cross wires of large Y Level	5.00	.16
168	Diagonal Prism for eyepiece of telescope. See page 93	8.00	.16
170	Plummet Lamp for Mine Engineering. See page 94	10.00	.35
173	Quick Leveling Attachment	6.00	.35
174	Quick Leveling Attachment, if ordered with any new Transits Nos. 1 to 105	5.00	
176	Leveling Head with plates, leveling screws and clamp and tangent, fitted to Transits Nos. 110 to 118. See page 163	18.00	
180	Attached Magnifier with three universal joints, to read verniers. See page 86	5.00	

ATTACHMENTS AND EXTRAS FOR TRANSITS

No.		PRICE	POST
185	Graduation of limb to read to 20 or 30 seconds, extra	\$10.00	
186	Graduation of limb to read to 10 seconds, extra	30.00	
187	Graduation of 4½ or 5 inch vertical circle to read to 20 or 30 seconds, extra	5.00	
188	Graduation of No. 188 Vertical Circle to read to 20 or 30 seconds, extra	10.00	
190	Solar Attachment with declination arc, hour circle and polar axis. See page 95	60.00	\$0.30
191	Telescopic Solar Attachment. See page 115	110.00	
192	Solar Screen to fit eyepiece of telescope. See page 120	5.00	.14
193	Patent Latitude Level, for use with Solar Transit. See page 121	6.00	.17
195	Jones Latitude Arc, with reversion level. See page 122	73.00	
196	Striding or Adjusting Level. See page 126	3.00	.17
197	Adjusting Bar for Solar Attachment of Transit.	1.50	.15

For tripods, see pages 223 to 228 and 327. For Leather Cases, see pages 229 and 328-329.

SOLAR COMPASS

No.		PRICE
210	Burt Solar Compass, with leveling screws and clamp and tangent to spindle, and tripod. See page 135	\$210.00

RAILROAD COMPASSES

No.		PRICE
215	Railroad Compass, two verniers to limb, limb reading to 1 minute, 5 inch needle, brass cover, outkeeper, and tripod	\$75.00
216	Railroad Compass, two verniers to limb, limb reading to 1 minute, 5½ inch needle, brass cover, outkeeper, and tripod. See page 143	80.00
220	Railroad Compass, one vernier to limb, limb reading to 1 minute, 5½ inch needle, brass cover, outkeeper, and tripod	65.00

These Compasses should always be used on a tripod when practicable. Tripods Nos. 415, 420, and 425 are adapted for use with these Compasses.

VERNIER COMPASSES

No.		PRICE
225	Vernier Compass, 4 inch needle, brass cover, outkeeper, and staff mountings	\$30.00
226	Vernier Compass, 5 inch needle, brass cover, outkeeper, and staff mountings	35.00
227	Vernier Compass, 6 inch needle, brass cover, outkeeper, and staff mountings. See page 149	40.00

PLAIN COMPASSES

No.		PRICE
230	Plain Compass, 4 inch needle, brass cover, out-keeper, and staff mountings	\$25.00
231	Plain Compass, 5 inch needle, brass cover, out-keeper, and staff mountings	30.00
232	Plain Compass, 6 inch needle, brass cover, out-keeper, and staff mountings. See page 161.	35.00

Compasses Nos. 210 to 232 are packed in mahogany case, with lock and leather strap. A Compass Tripod (our No. 415) will be furnished with any of these Compasses, Nos. 225 to 232, at an extra cost of \$7.00; and if the staff mountings are omitted we deduct \$2.00.

ATTACHMENTS AND EXTRAS FOR COMPASSES

No.		PRICE	POST
240	Compound Tangent Ball Spindle. See page 162	\$9.00	\$0.30
241	Leveling Adopter, large size. See page 162	7.00	.40
242	Leveling Head with plates, leveling screws and clamp and tangent, fitted to use with tripods Nos. 401, 406, 411, 415, 420, and 425. See page 163	18.00	
245	Compass Tripod Mountings, without the legs	5.00	.60

For Tripods, see pages 223 to 228 and 327. For Leather Cases, see pages 229 and 328-329.

TELESCOPIC SIGHTS

ATTACHABLE TO COMPASS SIGHT. SEE PAGES 165-171

No.		PRICE	POST
261	Achromatic Telescope, 9 inch, power about 20 diameters	\$18.00	\$0.45
262	Achromatic Telescope, 9 inch, same as No. 261, and with stadia wires	20.00	.50
	We add to the Telescopic Sight the following extras		
265	Vertical Circle, with vernier to 5 minutes	5.00	
266	Level on Telescope, with ground and graduated vial	5.00	
267	Clamp and Tangent to telescope axis	5.00	
268	Offset standard with counterpoise, to bring the telescope over the line of zeros	7.50	.50

POCKET SOLAR COMPASSES

No.		PRICE
275	Pocket Solar Compass, one vernier to limb, limb reading to 1 minute, 3 inch needle, with two levels, folding sights and staff mountings	\$100.00
276	Pocket Solar Compass, with light tripod	105.00
277	Pocket Solar Compass, with light extension tripod	110.00

POCKET SOLAR COMPASSES

No.		PRICE	POST
278	Pocket Solar Compass, with light extension tripod, and leveling head with clamp and tangent. See page 173.	\$120.00	
280	Side Telescope and Counterpoise fitted to new Pocket Solar Compass	25.00	

POCKET RAILROAD COMPASSES

No.		PRICE
285	Pocket Railroad Compass, one vernier to limb, limb 5 inches diameter reading to 1 minute, and with clamp and tangent, 3½ inch needle, folding sights, two levels, staff mountings, and tripod. See page 175	\$50.00
288	Pocket Railroad Compass, one vernier to limb with clamp and tangent, limb inside the compass circle and reading to 1 minute, 4½ inch needle, folding sights, two levels, staff mountings and tripod	39.00
291	Pocket Railroad Compass, 4½ inch needle, clamp and tangent to limb, limb reading to 1 minute, clamp and tangent to spindle, and fitted with Telescopic Sight No. 261, with extras of level, vertical circle to 5 minutes, clamp and tangent to telescope axis, and tripod	77.00
292	Pocket Railroad Compass, same as No. 291, but with Telescope No. 262.	79.00
293	Pocket Railroad Compass, same as No. 292, and with Leveling Adopter, complete as shown on page 179	84.00

POCKET VERNIER COMPASSES

No.		PRICE	POST
300	Pocket Vernier Compass, 3½ inch needle, folding sights, two levels and staff mountings. See page 181	\$16.00	\$0.70
305	Pocket Vernier Compass, 4½ inch needle, folding sights, two levels and staff mountings. See page 181	18.00	1.10
311	Pocket Vernier Compass, 4½ inch needle, clamp and tangent to spindle, and fitted with Telescopic Sight No. 261, with extras of level, vertical circle to 5 minutes, clamp and tangent to telescope axis and tripod.	62.00	
312	Pocket Vernier Compass, same as No. 311, but with Telescopic Sight No. 262. See page 183.	64.00	

POCKET PLAIN COMPASSES

No.		PRICE	POST
315	Pocket Plain Compass, 2½ inch needle, and folding sights	\$3.00	\$0.25
316	Pocket Plain Compass, 2½ inch needle, folding sights and staff mountings. See page 184	10.00	.35
317	Pocket Plain Compass, 3½ inch needle and folding sights	10.00	.40
318	Pocket Plain Compass, 3½ inch needle, folding sights, and staff mountings. See page 184	12.50	.50
319	Pocket Plain Compass, 3½ inch needle, folding sights, two levels and staff mountings	14.00	.50

EXTRAS FOR POCKET COMPASSES

No.		PRICE	POST
325	Clamp and Tangent fitted to ball spindle of Compasses Nos. 285, 288, 300, 305, and 315 to 319	\$5.00	
326	Rack and Pinion to variation arc of Compasses Nos. 288 to 312	4.00	
327	Leveling Adopter, small size. See page 185	5.00	\$0.25
328	Leveling Head with plates, leveling screws and clamp and tangent to spindle	10.00	

For Tripods, see pages 223 to 228 and 327. For Leather Cases, see pages 229 and 328-329.

GEOLOGISTS AND CLINOMETER COMPASSES

No.		PRICE	POST
335	Geologists Compass (of aluminum), U. S. Forest Service pattern, graduated movable sighting circle, graduated base, variation arc, folding sights, two levels, clinometer and staff mountings. See page 186	\$24.00	\$0.35
338	Clinometer Compass (of brass), 3½ inch needle, folding sights, square base, two levels, clinometer and staff mountings. See page 188.	16.00	.50

A light tripod for these compasses costs extra \$6.00.

MINERS COMPASSES OR DIPPING NEEDLES

FOR PROSPECTING FOR MAGNETIC IRON ORE

No.		PRICE	POST
340	Miners Dip Compass, 3 inch needle with stop, glass on both sides, in wood case. See page 189	\$16.00	\$0.25
340A	Miners Dip Compass, 3 inch needle with stop, glass on both sides, in wood case, and with level	18.00	

MINERS COMPASSES OR DIPPING NEEDLES

FOR PROSPECTING FOR MAGNETIC IRON ORE

No.		PRICE	POST
341	Miners Dip Compass, 3 inch needle with stop, glass on both sides, with brass covers. See page 189	16.00	.35
341A	Miners Dip Compass, 3 inch needle with stop, glass on both sides, with brass covers, and with level.	18.00	
344	Miners Dip Compass, 3 inch Norwegian needle with stop, glass on both sides, with brass covers. See page 189.	16.00	.35

MINERS COMPASSES OR DIPPING NEEDLES

FOR TRACING VEINS OF MAGNETIC IRON ORE

No.		PRICE	POST
345	Miners Dip Compass, 4 inch Norwegian needle with stop, glass on both sides, with brass covers. See page 189	\$20.00	\$0.50

DIAL COMPASSES

No.		PRICE	POST
348	Brass Dial Compass, with hour circle graduated for any latitude as ordered, variation arc, graduated base, one folding sight, two levels and clinometer. See page 192.	\$18.00	\$0.40
349	Dial Compass, same as No. 348, and with staff mountings complete	20.50	.50
350	Aluminum Dial Compass, with hour circle graduated for any latitude as ordered, graduated base, graduated movable sighting circle, variation arc, one folding sight, one removable sight, two levels, clinometer and staff mountings. See page 194	30.00	.45
	Extra Hour Circles, graduated for any latitude as ordered, to fit either of these Dial Compasses, each	5.00	.14

A light tripod for Dial Compasses Nos. 349 and 350 costs extra \$6.00.

LEVELING INSTRUMENTS

ENGINEERS Y LEVELS

No.		PRICE
375	Y Level, 22 inch telescope, with leveling screws, clamp and tangent and tripod	\$115.00
376	Y Level, 20 inch telescope, with leveling screws, clamp and tangent and tripod. See page 195	110.00
377	Y Level, 18 inch telescope, with leveling screws, clamp and tangent and tripod	110.00
378	Y Level, 15 inch telescope, with leveling screws, clamp and tangent and tripod. See page 201	90.00

Y Levels Nos. 375 to 378 are regularly supplied with plain tripods. A split leg tripod may be substituted, if preferred, for \$2.00 extra, or an extension leg tripod for \$5.00 extra.

ARCHITECTS Y LEVELS

No.		PRICE
380	Architects Level, 12 inch telescope, with leveling screws, and tripod. See page 213	\$50.00
381	Architects Level, 12 inch telescope, with leveling screws, clamp and tangent and tripod. See page 213	65.00

A compass, without sights and with 3 inch needle, can be attached to the telescopes of these leveling instruments, Nos. 375 to 381, and used to obtain the bearing of lines when desired; its extra cost is \$10.00. Stadia wires are furnished with any of our Y Levels, free of charge, if requested when the instrument is ordered. A horizontal circle attached to any of our Y Levels costs \$15.00. See page 199.

Architects Y Levels Nos. 380 and 381 are regularly supplied with plain tripods. A split leg tripod may be substituted, if preferred, for \$5.00 extra, or an extension leg tripod for \$7.00 extra.

DRAINAGE LEVELS

No.		PRICE
385	Drainage Level, with staff mountings	\$15.00
386	Drainage Level, with staff mountings and tripod	20.00
387	Drainage Level, with staff mountings, leveling screws and tripod. See page 218	25.00
388	Drainage Level, same as No. 387, and with compass attached. See page 219	30.00

Stadia wires will be inserted in Drainage Levels, if required, for \$5.00 extra.

Drainage Levels Nos. 387 and 388 are regularly supplied with plain tripods. A split leg tripod may be substituted for \$3.00 extra, or an extension leg tripod for \$5.00 extra.

All our Levels, Nos. 375 to 388, are packed in mahogany case with lock, and strap or handle. For Level Tripods, see pages 223 to 228 and 327. For Leather Cases, see pages 229, 328 and 329.

TRANSIT TRIPODS

No.		PRICE
400	Plain Tripod for Transits Nos. 1 to 90. See page 224	\$10.00
401	Plain Tripod for Transits Nos. 100 to 117	7.00
405	Split Leg Tripod for Transits Nos. 1 to 90. See page 227	12.00
406	Split Leg Tripod for Transits Nos. 100 to 117	10.00
410	Extension Tripod for Transits Nos. 1 to 90. See page 228	15.00
411	Extension Tripod for Transits Nos. 100 to 117	12.00

COMPASS TRIPODS

No.		PRICE
415	Plain Tripod for Compasses Nos. 210 to 232. See page 226	\$7.00
416	Plain Tripod for Pocket Compasses Nos. 275 to 319	6.00
420	Split Leg Tripod for Compasses Nos. 210 to 232	10.00
421	Split Leg Tripod for Pocket Compasses Nos. 275 to 319	8.00
425	Extension Tripod for Compasses Nos. 210 to 232	12.00
426	Extension Tripod for Pocket Compasses Nos. 275 to 319	10.00

LEVEL TRIPODS

No.		PRICE
430	Plain Tripod for Levels Nos. 375 to 378. See page 224	\$10.00
431	Plain Tripod for Levels Nos. 380 and 381	7.00
432	Plain Tripod for Levels Nos. 385 to 388	6.00
435	Split Leg Tripod for Levels Nos. 375 to 378. See page 227	12.00
436	Split Leg Tripod for Levels Nos. 380 and 381	10.00
437	Split Leg Tripod for Levels Nos. 385 to 388	8.00
440	Extension Tripod for Levels Nos. 375 to 378. See page 228	15.00
441	Extension Tripod for Levels Nos. 380 and 381	12.00
442	Extension Tripod for Levels Nos. 385 to 388	10.00

When ordering a separate tripod, the customer should always specify for what instrument it is wanted.

BRASS PLUMMETS. PLAIN

No.		PRICE	POST
450	Plummet, screw head, steel point, 6 oz.	\$1.00	\$0.15
452	Plummet, screw head, steel point, 10 oz.	1.50	.20
454	Plummet, screw head, steel point, 16 oz.	2.00	.25
456	Plummet, screw head, steel point, 24 oz.	2.75	.35
458	Plummet, screw head, steel point, 32 oz.	3.50	.45
460	Plummet, screw head, steel point, long neck, 12 oz.	2.00	.25



BRASS PLUMMETS. ADJUSTABLE

These Plummetts have a concealed reel, R, around which the string is wound by turning the milled head, K, on top. The friction upon the reel will hold the Plummet at any desired point of the line.

No.		PRICE	POST
465	Adjustable Plummet, 10 oz.	\$2.50	\$0.20
469	Adjustable Plummet, 30 oz.	5.00	.45
471	Iron Spads, for suspend- ing plummetts in mines, per 100	1.50	.15
472	Stake Tacks, galvanized, 2 oz. box10	.04
473	Stake Tacks, galvanized, 1 lb. box50	.20
474	Plummet Cord, braided linen, per 25 yards . .	.38	.04

SOLE LEATHER CASES, WITH SHOULDER STRAPS TO FIT OUTSIDE THE WOODEN BOX

No.		PRICE
475	For Engineers or Surveyors Transits. Price according to size	\$8.00 to \$10.00
476	For Mountain, Reconnoissance or Builders Transits	8.00
477	For Large Solar Compass	10.00
478	For Surveyors Compasses, Nos. 215 to 232 price according to size	6.00 to 9.00
479	For Engineers Y Levels. Price according to size	8.00 to 10.00
480	For Architects Levels	6.00
481	For Drainage Levels	4.00

See page 229

No.		PRICE	POST
485	For Compasses Nos. 315, 316, 335, 340 to 344, 348 to 350	\$2.50	\$0.22
486	For Compasses Nos. 300, 317 to 319, 338, 345	3.00	.32
487	For Compasses Nos. 275, 285, 288, 305	4.00	.50
488	For Compasses Nos. 291 to 293, 311, 312	6.00	

Leather Pouch and Shoulder Strap, fitted to receive
Pocket Compasses without the wooden box. See page 229.

SOLE LEATHER CASES

To FIT OUTSIDE THE WOODEN BOX

No.		PRICE	POST
490	For Compasses Nos. 315, 316, 335, 340 to 344, 348 to 350	\$2.00	\$0.18
491	For Compasses Nos. 300, 317 to 319, 338, 345	2.50	.28
492	For Compasses Nos. 288, 305	3.00	.38

TRIPOD CASES

No.		PRICE
494	Leather Case, with cap and carrying handle, for extension tripod	\$10.00
497	Canvas Case, with leather trimmings, for extension tripod	7.50

ENGINEERS FIELD BAG

No.		PRICE	POST
498	Engineers Field Bag, made of heavy pliable leather, with two extra pockets and with shoulder strap. Inside measure: 9 inches long, 7 inches high, 2½ inches wide	\$4.00	\$0.35

We make to order Leather Cases and Pouches of any style and size that may be desired. See page 229.

LEVELING RODS. SEE PAGES 230-241

No.		PRICE
500	Philadelphia Rod, 2 ply, 7 ³ / ₁₀ feet closed, sliding to 13 feet, graduated to feet, 10ths and 100ths, with vernier reading to 1000ths	\$14.00
500B	Philadelphia Rod, 2 ply, 7 ³ / ₁₀ feet closed, sliding to 13 feet, graduated to feet and 10ths, with both target and rod reading by natural scales to half hundredths	14.00
501	Philadelphia Rod, 3 ply, 5 ³ / ₁₀ feet closed, sliding to 13 feet, graduated to feet, 10ths and 100ths, with vernier reading to 1000ths	18.00
501B	Special Self-reading Rod, 3 ply, 7 ⁶ / ₁₀ feet closed, sliding to 20 feet, graduated on four faces to feet and 10ths, and on back of the front section to feet, 10ths and 100ths; also reading by two scales to half hundredths. With aluminum target and canvas case	20.00

LEVELING RODS

No.		PRICE
502A	Philadelphia Mining Rod, 2 ply, 3 $\frac{3}{10}$ feet closed, sliding to 5 feet, graduated to feet, 10ths and 100ths, with vernier reading to 1000ths	\$12.00
503	Boston Rod, 2 ply, 6 feet closed, sliding to 11 feet, graduated to feet, 10ths and 100ths, with vernier reading to 1000ths	14.00
504	Troy Rod, 2 ply, 6 $\frac{1}{2}$ feet closed, sliding to 12 feet, graduated to feet, 10ths and 100ths, with vernier reading to 1000ths	10.00
505	New York Rod, 2 ply, 6 $\frac{8}{10}$ feet closed, sliding to 12 feet, graduated to feet, 10ths and 100ths, with vernier reading to 1000ths	14.00
507	New York Rod, 3 ply, 5 feet closed, sliding to 12 $\frac{1}{2}$ feet, graduated to feet, 10ths and 100ths, with vernier reading to 1000ths	18.00
509	New York Mining Rod, 2 ply, 3 $\frac{3}{10}$ feet closed, sliding to 5 $\frac{1}{10}$ feet, graduated to feet, 10ths and 100ths, with vernier reading to 1000ths	12.00
510	Architects Rod, 2 ply, 5 $\frac{1}{2}$ feet closed, sliding to 10 feet, graduated to feet, inches and 16ths	6.00
511	Architects Rod, 2 ply, 5 $\frac{1}{2}$ feet closed, sliding to 10 feet, graduated to feet, 10ths and 100ths with vernier reading to 1000ths	6.00
512	Machinists Rod, one piece, 6 $\frac{1}{2}$ feet long, for leveling shafting, graduated to feet, inches and 16ths	5.00
513	Telemeter or Stadia Rod, without target, hinge joint, 6 feet folded, unfolding to 12 feet, graduated to feet, 10ths and 100ths	12.00
514	Telemeter or Stadia Rod, without target, hinge joint, 7 feet folded, unfolding to 14 feet, graduated to feet, 10ths and 100ths	13.00
515	Telescopic Rod, 3 ply, without target, 5 feet closed, sliding to 14 feet, graduated to feet, 10ths and 100ths	22.00
516	Cross Section Rod, one piece, without target, 10 feet long, with level vial at each end, graduated to feet, 10ths and 100ths	10.00
518A	Plain Rod, one piece, without target, 10 feet long, graduated to feet, 10ths and 100ths	6.00
518B	Plain Rod, without target, with hinge joint, 5 feet folded, unfolding to 10 feet, graduated to feet, 10ths and 100ths	8.00
519A	Plain Rod, one piece, without target, 12 feet long, graduated to feet, 10ths and 100ths	7.00
519B	Plain Rod, without target, with hinge joint, 6 feet folded, unfolding to 12 feet, graduated to feet, 10ths and 100ths	9.00

LEVELING RODS

No.		Price
520A	Plain Rod, one piece, without target, 14 feet long, graduated to feet, 10ths and 100ths	\$8.00
520B	Plain Rod, without target, with hinge joint, 7 feet folded, unfolding to 14 feet, graduated to feet, 10ths and 100ths	10.00
521B	Plain Rod, without target, with hinge joint, 8 feet folded, unfolding to 16 feet, graduated to feet, 10ths and 100ths	11.00
522A	Plain Rod, 2 ply, without target, 5 $\frac{3}{10}$ feet long, sliding to 10 feet, graduated to feet, 10ths and 100ths	8.00
522B	Plain Rod, 2 ply, without target, 6 $\frac{3}{10}$ feet long, sliding to 12 feet, graduated to feet, 10ths and 100ths	9.00
522C	Plain Rod, 2 ply, without target, 7 $\frac{3}{10}$ feet long, sliding to 14 feet, graduated to feet, 10ths and 100ths	10.00
524A	Plain Rod, 4 ply, without target, 3 $\frac{3}{8}$ feet long, sliding to 11 $\frac{3}{8}$ feet, graduated to feet, 10ths and 100ths	12.00

Any of our Leveling Rods made with metric graduations without extra charge.

Canvas Case for regular pattern Philadelphia or New York Rod, \$3.00; other sizes and styles made to order.

FLEXIBLE OR POCKET LEVELING RODS

Made of canvas, can be coiled up and carried in pocket. In use it is fastened to a board with thumb tacks.



No. 526A

No.		Price	Post
525A	Pocket Rod, 8 feet long, graduated to feet, 10ths and 100ths	\$3.00	\$0.22
525B	Pocket Rod, 10 feet long, graduated to feet, 10ths and 100ths	3.25	.25
526A	Pocket Rod, 12 feet long, graduated to feet, 10ths and 100ths	4.00	.28
526B	Pocket Rod, 12 feet long, graduated to feet, inches and 8ths	4.00	.28
527	Pocket Rod, 14 feet long, graduated to feet, 10ths and 100ths	4.50	.30
528	Pocket Rod, 3 $\frac{1}{2}$ meters long, graduated to centimeters	4.00	.30

COMBINED LEVELING POLE AND FLAGSTAFF

No.		PRICE
530	Wood Leveling Pole and Staff, 7 feet long. See page 241	\$5.00
531	Wood Leveling Pole and Staff, 9 feet long	6.00

WOOD FLAGSTAFFS. SEE PAGE 242

These staffs are divided in feet, which are painted alternately red and white.

No.		PRICE
534	Wood Staff, 6 feet long, with metal shoe	\$2.00
535	Wood Staff, 8 feet long, with metal shoe	2.25
536	Wood Staff, 10 feet long, with metal shoe	2.50

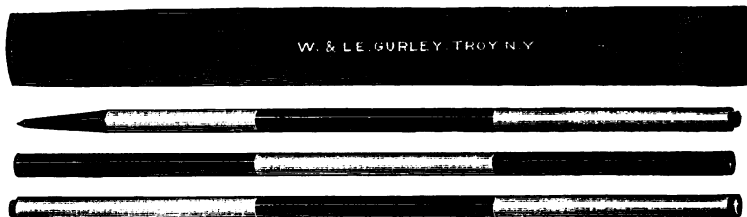
WOOD FLAGSTAFFS. JOINTED AND IN CANVAS CASES

No.		PRICE
537A	Wood Staff, round, 6 feet long, with one screw joint.	\$4.50
537B	Wood Staff, round, 6 feet long, with one screw joint and with canvas case	7.00
538A	Wood Staff, round, 9 feet long, with two screw joints	7.50
538B	Wood Staff, round, 9 feet long, with two screw joints and with canvas case	10.50

IRON AND STEEL RANGING POLES

No.		PRICE
539	Aligning or Ranging Pole, 6 feet long, hung in gimbals	\$4.00
The aligning pole consists of an iron tube, $\frac{1}{4}$ of an inch in diameter, 6 feet long, and being hung in gimbals always assumes a vertical position.		
540A	Steel Ranging Pole, solid, hexagonal, 6 feet long, $\frac{1}{2}$ inch diameter	2.75
540B	Steel Ranging Pole, solid, hexagonal, 8 feet long, $\frac{1}{2}$ inch diameter	3.00
541	Iron Tubular Ranging Pole, 6 feet long, $\frac{1}{4}$ inch diameter	2.75

IRON AND STEEL RANGING POLES

No.		PRICE
543	Iron Tubular Ranging Pole, 8 feet long, $\frac{1}{2}$ inch diameter	\$3.00
544	Iron Tubular Ranging Pole, 10 feet long, $\frac{1}{2}$ inch diameter	3.50

Any of the above staffs and poles with metric graduations (five to a meter) at the same price.

ROD LEVELS

No.		PRICE	POST
545	Rod Level, for plumbing a Rod or Staff. See page 243	\$3.00	\$0.15
546	Circular Rod Level, with folding joint	3.00	.15
547	Circular Rod Level for Precise Rods. See page 244	6.00	.20

PLANE TABLE OUTFITS

No.		PRICE
549	Plane Table with board 30 x 24 inches, mounted on large tripod with leveling socket and clamp, and with plumbing arm, plummet and clamps for paper	\$45.00
	Set of three leveling screws, No. 563	10.00
	Clamp and tangent, for orienting, No. 564	10.00
	Combined Compass with levels and square base	15.00
	Alidade with telescope 11 inches long, with stadia, $4\frac{1}{2}$ inch vertical circle to 1 minute, level on telescope and clamp and tangent, on column, power of telescope 24 diameters. See page 252, No. 583	90.00
	Total, as shown on page 248	<u>\$170.00</u>
550	Plane Table, with board, tripod, etc., as in No. 549	\$45.00
	Combined Compass with levels and square base	15.00
	Alidade with telescope 11 inches long, with stadia, $4\frac{1}{2}$ inch vertical circle to 1 minute, level on telescope and clamp and tangent, on column, power of telescope 24 diameters. See page 252, No. 583	90.00
	Total	<u>\$150.00</u>
553	Plane Table, with board, tripod, etc., as in No. 549	\$45.00
	Combined Compass with levels and square base	15.00
	Alidade with telescope 9 inches long, power 20 diameters, with stadia, vertical circle to 1 minute, level on telescope and clamp and tangent, on column. See page 245, No. 582	70.00
	Total, as shown on page 245	<u>\$130.00</u>
556	Plane Table, with board, tripod, etc., as in No. 549	\$45.00
	Combined Compass with levels and square base	15.00
	Alidade with telescopic sight No. 262, with stadia, vertical circle to 5 minutes, level and clamp and tangent. See page 252, No. 581	50.00
	Total	<u>\$110.00</u>
559	Plane Table, with board, tripod, etc., as in No. 549	\$45.00
	Combined Compass with levels and square base	15.00
	Alidade with sight vanes. See page 251, No. 580	15.00
	Total	<u>\$75.00</u>
560	Plane Table, with board, tripod, etc., as in No. 549, and omitting Compass and Alidade.	\$45.00
563	Set of three leveling screws for Plane Tables Nos. 550 to 560, extra	10.00
564	Clamp and tangent, for orienting, for Plane Tables Nos. 550 to 560, extra	10.00
	Beaman Stadia Arc No. 149, fitted to Alidades Nos. 582 and 583	15.00

JOHNSON PLANE TABLE AND EXTRAS

PRICES FOR SEPARATE PARTS.

PAGE 249

No.		PRICE
570	Johnson Plane Table Movement and plain tripod. If tripod has extension legs, the extra cost is \$10.00	\$35.00
573	Drawing Board, 31 x 24 inches, with brass screw plate fitted, and with eight clamp screws and sockets for paper	5.00
	Canvas covered wooden case for No. 573	6.00
	Flexible canvas case for No. 573	2.00
	Eggshell Drawing Paper, single mounted, 31 x 24 inches, per sheet	.75
	Eggshell Drawing Paper, double mounted (muslin between), 31 x 24 inches, per sheet	1.50
573A	Drawing Board, 18 x 24 inches, with brass screw plate fitted, and with eight clamp screws and sockets for paper	4.50
	Canvas covered wooden case for No. 573A	5.00
	Flexible canvas case for No. 573A	1.50
	Eggshell drawing paper, single mounted, 18 x 24 inches, per sheet.	.60
	Eggshell drawing paper, double mounted (muslin between), 18 x 24 inches, per sheet.	1.20
574	Plumbing arm and plummet	4.00
575	Combined Compass with levels and square base	15.00
	Drawings can be made on both sides of double mounted paper.	
576	Johnson Plane Table Movement and tripod, with drawing board, 31 x 24 inches, with brass screw plate fitted, and with eight clamp screws and sockets for paper	40.00
	Plumbing arm and plummet	4.00
	Combined Compass with levels and square base	15.00
	Alidade with telescope 11 inches long, with stadia, 4½ inch vertical circle to 1 minute, level on telescope and clamp and tangent, on column, power of telescope 24 diameters. See page 252, No. 583	90.00
	Total, as shown on page 250	<u>\$149.00</u>
577	Plane Table, with tripod, board, etc., as in No. 576	\$40.00
	Plumbing arm and plummet	4.00
	Combined Compass with levels and square base	15.00
	Alidade with telescope 9 inches long, power 20 diameters, with stadia, vertical circle to 1 minute, level on telescope and clamp and tangent, on column, No. 582	70.00
	Total	<u>\$129.00</u>

JOHNSON PLANE TABLE OUTFITS

No.		PRICE
578	Plane Table, with tripod, board, etc., as in No. 576	\$40.00
	Plumbing arm and plummet	4.00
	Combined Compass with levels and square base	15.00
	Alidade with Telescopic Sight No. 262, with stadia, vertical circle to 5 minutes, level and clamp and tangent. See page 252, No. 581	50.00
	Total	<u>\$109.00</u>
579	Plane Table, with tripod, board, etc., as in No. 576	\$40.00
	Plumbing arm and plummet	4.00
	Combined Compass with levels and square base	15.00
	Alidade with sight vanes. See page 251, No. 580	15.00
	Total	<u>\$74.00</u>

ALIDADES

No.		PRICE
580	Alidade with Compass sights. See page 251.	\$15.00
581	Alidade with telescopic sight No. 262, with stadia, vertical circle to 5 minutes, level and clamp and tangent. See page 252	50.00
582	Alidade with telescope 9 inches long, power 20 diameters with stadia, vertical circle to 1 minute, level on telescope and clamp and tangent, on column, as in illustration. See page 245	70.00
583	Alidade with telescope 11 inches long, with stadia, 4½ inch vertical circle to 1 minute, level on telescope and clamp and tangent, on column, power of telescope 24 diameters. See page 252	90.00
584A	Alidade with telescope 11 inches long, with inverting eyepiece, stadia, vertical arc of 1 minute, detachable striding level, axis tangent, diagonal prism for eyepiece. The telescope has a power of 16 diameters, and is mounted on column. See page 253	118.00
584B	Alidade same as No. 584 A, but with erecting eyepiece	118.00
585	Box Compass, rectangular metal case, 4 inch needle, fitted to Alidades Nos. 584A and 584B	10.00
	Beaman Stadia Arc No. 149, fitted to Alidades Nos. 584A and 584B	30.00

The Alidades as above described can be used with any of our Plane Tables Nos. 549 to 579, and will be sold separately at the prices named.

TRAVERSE PLANE TABLE. U. S. G. S. PATTERN

No.	PRICE
586 Improved Traverse Plane Table Board, 15 x 15 inches, with Box Compass let into one edge, Ruler Alidade with graduated edge, folding sights and leather pouch, tripod with plunger clamp and spring board plate, four clamp screws and sockets for paper, complete as shown on page 254	\$30.00

If tripod with extension legs is required the extra cost is \$5.00.
Flexible waterproof case for board, \$1.00 extra.

When desired, we furnish separate parts of Plane Table No. 586 at the following prices:

TRAVERSE PLANE TABLE. PARTS AND EXTRAS

No.	PRICE
587 Drawing Board with improved spring board, plate, tripod head. Four clamp screws and sockets for paper and plain legs	\$12.00
588 Box Compass, rectangular metal case, 4 inch needle	8.00
589 Ruler Alidade, 10 inches long, with graduated edge, folding sights and with leather pouch	12.00
590A Pocket Alidade, 6 inches long, with graduated edge and folding sights, and with leather case with pencil pockets	7.50
590B Extra folding sights for Alidade No. 590A, per pair	3.25
591 Pocket Alidade, 7 inches long, with graduated edge, one peep sight and one folding sight, and with leather case with pencil pockets	12.00

SKETCHING CASES

No.	PRICE
594 Army Sketching Case, Glenn S. Smith patent, as illustrated on page 257, with one protractor card as selected, and clinometer	\$22.50
Tripod	3.50
Extra Protractor Cards, 1 to 1, 2 to 1, 3 to 1, 24000, 48000. Each	1.00
Canvas Pouch with leather carrying strap	2.00
Staff, 2 ft. long, with metal shoe	1.00
Vellum Tracing Paper, in rolls 8 in. by 36 in. Each10
595 Batson Sketching Case, with leather case. See page 259	30.00
Wood Staff, about 2 feet long, with steel pointed shoe, extra	1.00
Plain Tripod, about 3½ feet long, extra	3.50

CURRENT METERS

See pages 261 to 279

For measuring the velocity of the current of rivers and harbors, at any depth.

No.		Price
600	Current Meter for Harbors and Rivers. See page 262	\$80.00
604	Brass Tubing, graduated to feet and 10ths, and jointed in 4 ft. lengths, per length	5.00
606	Lead Weight, 60 lbs., with connections. See page 262	15.00
609	Electric Register. See page 262	50.00
612	Dry Cell or Wet Cell Battery of three cells, in box with lock and strap	7.00
614	Insulated Copper Wire for battery, for use with Meter No. 600, per foot03
615	Telephone Sounder with dry cell battery and 40 feet of cable	11.00
	Time Recorder	8.00
616	Acoustic Current Meter, including two 2 ft. lengths of graduated brass tube, wooden box with lock and strap, and accessories of oil can, wrench, screw driver and extra pivot bearing. See page 274	50.00
	Extra Graduated Brass Tube, per 2 ft. length	2.50
	Canvas Case for 2, 3 or 4 lengths of tube	2.50
	Time Recorder	8.00
617	Electric Current Meter indicating each revolution, including telephone sounder with dry or wet cell battery, 20 ft. of cable and 6½ lb. torpedo shaped lead weight. All packed in wooden box with lock, hooks and strap, and including accessories of oil can, wrench, screw driver, extra pivot bearing, binding screws and nipple. See page 265	63.50
	Extra Cable, per foot05
	Extra Lead Weight, 6½ lbs.	3.50
	Extra Lead Weight, 15 lbs.	5.00
	Time Recorder	8.00
	Wading Rods, per 1½ ft. length	2.50
	Base for rod	1.25
	Hanger for rod	3.00
	Leather Case for rod and accessories	3.50
618	Electric Current Meter with base, for shallow streams, omitting vane and weight, including telephone sounder with dry or wet cell battery, 20 ft. cable and two 2 ft. lengths of graduated brass tube. Meter, sounder and cable, packed in wooden box with lock	

CURRENT METERS

No.		PRICE
	and strap, and including accessories of oil can, wrench, screw driver and extra pivot bearing. See page 266	\$62.50
	Extra Cable, per foot03
	Extra Graduated Brass Tube, per 2 ft. length	2.50
	Canvas Case for 2, 3 or 4 lengths of tube	2.50
	Time Recorder	8.00
619	Time Recorder	8.00
621	Electric Current Meter, indicating every fifth revolution, including telephone sounder, with dry or wet cell battery, 20 ft. cable and 6½ lb. torpedo shaped lead weight. All packed in wooden box with lock, hooks and strap and including accessories of oil can, wrench, screw driver, extra pivot bearing, binding screws and nipple. See page 278	63.50
	Extra Cable, per foot05
	Extra Lead Weight, 6½ lbs.	3.50
	Extra Lead Weight, 15 lbs.	5.00
	Time Recorder	8.00
	Wading Rods, per 1½ ft. length	2.50
	Base for rod	1.25
	Hanger for rod	3.00
	Leather Case for rod and accessories	3.50
<p>NOTE — The vane or tail piece of Meter No. 617 or 621 can be detached from its yoke or head, and the Meter can be used, in connection with Wading Rods and accessories, in shallow streams in the same manner as No. 618.</p>		
623	Electric Current Meter with two interchangeable commutator boxes, one indicating each revolution, and the other each fifth revolution of bucket wheel. Covert pattern yoke, telephone sounder, dry battery, twenty feet of cable, and 6½ lb. torpedo shaped lead weight. All packed in wooden box with lock, hooks, and strap, and including accessories of oil can, wrench, screw driver, extra pivot bearing, binding screws, and nipple. See page 279	78.50
	Extra Cable, per foot05
	Graduated Brass Tube, 4 sections at \$2.50	10.00
	Leather Case for brass tube.	3.50
	Extra Lead Weight, 6½ lbs.	3.50
	Extra Lead Weight, 10 lbs.	4.00
	Extra Lead Weight, 15 lbs.	5.00
629	Boyden Hook Gage. See page 280	25.00

Water Registers, Tide Gauges, and similar instruments made to order from designs submitted.

HAND LEVELS

No.		PRICE	POST
640	Monocular Hand Level, in case. See page 232 .	\$12.00	\$0.20
641	Binocular Hand Level, in case. See page 232 .	15.00	.35
648	Locke Hand Level, nickel plated, in case. See page 234	8.00	.20
646	Abney Level, an improved Locke Hand Level, giving angles of elevation graduated for slopes, as 1 to 1, 2 to 1, etc., in case. See page 235 .	13.50	.25



No. 648

No.		PRICE	POST
648	Abney Level, an improved Locke Hand Level, similar to No. 646, and with compass, revolving circular base and plain staff socket	\$18.00	\$0.30

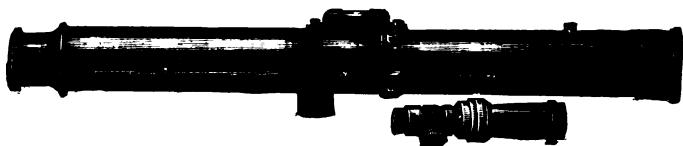

No. 649

No.		PRICE	POST
649	Stadia Hand Level, telescope 10 in. with object glass 1 in., adjustable eyepiece, stadia hairs reading 1:100, with ball joint and socket. Useful for preliminary surveys, etc.; weight about 1½ lbs., in leather sling case	\$18.00	\$0.40

Nos. 640 to 646 are our own make.
Nos. 648 and 649 are of foreign make.

CHAINS. SEE PAGES 286 TO 289

No.		PRICE	POST
650	33 feet, 50 links, oval rings, No. 10 refined iron wire	\$2.25	\$0.65
651	33 feet, 50 links, oval rings, No. 8 refined iron wire	2.50	.85
652	66 feet, 100 links, oval rings, No. 10 refined iron wire	3.50	1.15
653	66 feet, 100 links, oval rings, No. 8, refined iron wire	4.00	1.75
656	33 feet, 50 links, oval rings, No. 10 best steel wire	4.00	.65
658	50 feet, 50 links, oval rings, No. 10 best steel wire	4.75	.80
660	66 feet, 100 links, oval rings, No. 10 best steel wire	7.00	1.15
662	100 feet, 100 links, oval rings, No. 10 best steel wire	8.50	1.50

BRAZED STEEL CHAINS

No.		PRICE	POST
670	33 feet, 50 links, No. 12 tempered steel wire, brazed links and rings	\$5.00	\$0.45
671	50 feet, 50 links, No. 12 tempered steel wire, brazed links and rings	6.00	.55
672	66 feet, 100 links, No. 12 tempered steel wire, brazed links and rings	9.00	.70
673	100 feet, 100 links, No. 12 tempered steel wire, brazed links and rings	10.00	1.00

Our brazed steel chains displace the ordinary chains wherever they are tried, on account of superior lightness and strength. They are practically the only chains now used in railroad construction.

Chains of two and four poles with 40 and 80 links, same price as chains of 50 and 100 links.

Steel snaps to make full chains into half chains, without extra charge, if ordered with the chain.

GRUMMAN PATENT STEEL CHAINS

See pages 288-289

No.		PRICE	POST
680	33 feet, 50 links, No. 15 tempered steel wire, weight 1 lb.	\$5.00	\$0.28
681	50 feet, 100 links, No. 15 tempered steel wire, weight 1¼ lbs.	6.00	.30
682	66 feet, 100 links, No. 15 tempered steel wire, weight 1½ lbs.	9.00	.35
683	100 feet, 200 links, No. 15 tempered steel wire, weight 2¼ lbs.	11.00	.50

GRUMMAN PATENT STEEL CHAINS

No.		PRICE	POST
685	50 feet, 100 links, No. 18 tempered steel wire, with spring balance, level and thermometer, for very accurate measurements, weight 14½ oz.	\$15.00	\$0.30
688	Spring balance for 6 lbs. strain, with handle and steel snap, to use with chains Nos. 680 to 683 .	2.50	.17

VARA CHAINS

No.		PRICE	POST
690	10 varas, 50 links, oval rings, No. 10 refined iron wire .	\$2.25	\$0.55
691	10 varas, 50 links, oval rings, No. 8 refined iron wire .	2.50	.75
694	20 varas, 100 links, oval rings, No. 10 refined iron wire .	3.50	1.00
695	20 varas, 100 links, oval rings, No. 8 refined iron wire .	4.00	1.65
700	10 varas, 50 links, oval rings, No. 10 best steel wire .	4.00	.55
704	20 varas, 100 links, oval rings, No. 10 best steel wire .	7.00	1.00
708	10 varas, 50 links, oval rings, No. 12 tempered steel wire, brazed links and rings .	5.00	.35
710	20 varas, 100 links, oval rings, No. 12 tempered steel wire, brazed links and rings	9.00	.65

METER CHAINS

No.		PRICE	POST
715	10 meters, 50 links, oval rings, No. 10 refined iron wire .	\$2.25	\$0.65
716	10 meters, 50 links, oval rings, No. 8 refined iron wire .	2.50	.85
719	20 meters, 100 links, oval rings, No. 10 refined iron wire .	3.50	1.15
720	20 meters, 100 links, oval rings, No. 8 refined iron wire .	4.00	1.75
723	10 meters, 50 links, oval rings, No. 10 best steel wire .	4.00	.65
727	20 meters, 100 links, oval rings, No. 10 best steel wire .	7.00	1.15
730	10 meters, 50 links, oval rings, No. 12 tempered steel wire, brazed links and rings .	5.00	.45
732	20 meters, 100 links, oval rings, No. 12 tempered steel wire, brazed links and rings	9.00	.70

MARKING PINS

		NICKEL PLATED	
No.		Price	Post
740	Set of 11 Pins, No. 4 iron wire, 14 inches long . .	\$1.25	\$0.50
742	Set of 11 Pins, No. 6 steel wire, 14 inches long . .	1.50	.40
744	Set of 11 Pins, No. 6 steel wire weighted, 14 inches long	2.50	1.25
746	Set of 11 Pins, No. 10 steel wire, 9 inches long, in leather pouch	2.00	.25
748	Set of 11 Pins, No. 4 brass wire, 14 inches long . .	2.50	.50

TIMBER SCRIBE

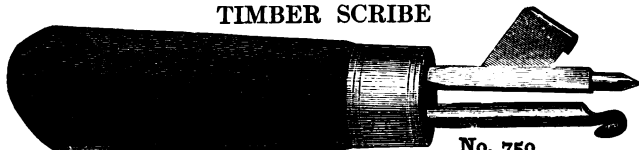

No. 750

No.		Price	Post
750	Timber Scribe, for marking trees, posts or boards	\$1.25	\$0.17

STEEL RIBBON CHAIN TAPES

1/4 INCH WIDE, ABOUT 1/10 INCH THICK, AND WITH HANDLES AND REEL



No. 760

No.		Price	Post
760	Steel Ribbon, 33 feet, graduated to 50 links only	\$3.50	\$0.25
761	Steel Ribbon, 50 feet, graduated each foot . . .	4.00	.30
762	Steel Ribbon, 66 feet, graduated to 100 links only	4.50	.35
763	Steel Ribbon, 100 feet, graduated each foot . .	5.00	.40
765	Steel Ribbon, 200 feet, graduated each foot up to 100 feet, and the last 100 feet graduated each 10 feet	7.50	.70
767	Steel Ribbon, 300 feet, graduated each foot up to 100 feet, and the last 200 feet graduated each 10 feet	10.00	

The 50, 100, 200, and 300 feet Chain Tapes also have the first and last foot in 10ths.

STEEL RIBBON BRIDGE TAPES

$\frac{1}{4}$ INCH WIDE, ABOUT $\frac{1}{100}$ INCH THICK, WITH HANDLES
AND EXTRA FINE REELS



No. 770

No.		PRICE
770	Steel Ribbon, 300 feet, graduated each 5 feet	\$13.00
771	Steel Ribbon, 400 feet, graduated each 5 feet	15.00
772	Steel Ribbon, 500 feet, graduated each 5 feet	17.00

Our Bridge Tapes are mounted on substantial wooden reels with aluminum and brass mountings and swivel handle.

These tapes have the first and last 5 feet graduated each foot.

Tapes, Nos. 760 to 772, have etched graduations.

STEEL RIBBON CHAIN TAPES. (SUPERIOR)

$\frac{1}{4}$ INCH WIDE, HEAVY STEEL RIBBON, DEEPLY ETCHED GRADUATIONS, LARGE DETACHABLE HANDLES AND FINE REEL WITH NICKELED TRIMMINGS

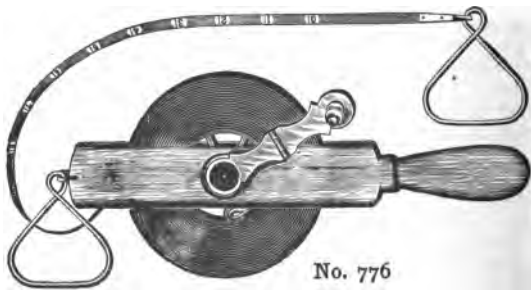

No. 776

STEEL RIBBON CHAIN TAPES. (SUPERIOR)

No.		PRICE	POST
774	Steel Ribbon, 66 feet, graduated to 100 links . .	\$5.00	\$0.40
775	Steel Ribbon, 132 feet, graduated to 200 links . .	7.00	.60
776	Steel Ribbon, 100 feet, graduated each foot . .	6.00	.50
777	Steel Ribbon, 200 feet, graduated each foot . .	9.00	
778	Steel Ribbon, 300 feet, graduated each foot . .	12.50	
779	Steel Ribbon, 500 feet, graduated each foot . .	21.50	

The 66 and 132 feet tapes have the first and last link in 10ths.
The 100, 200, 300, and 500 feet tapes have the first and last foot in 10ths.

STEEL RIBBON CHAIN TAPES. METRIC MEASURE ONLY

$\frac{1}{4}$ INCH WIDE, HEAVY STEEL RIBBON, DEEPLY ETCHED GRADUATIONS, DETACHABLE HANDLES AND FINE REEL
WITH NICKELED TRIMMINGS

No.		PRICE	POST
M-25	Steel Ribbon, 25 meters, graduated to decimeters	\$5.75	\$0.45
M-30	Steel Ribbon, 30 meters, graduated to decimeters	6.50	.50
M-50	Steel Ribbon, 50 meters, graduated to decimeters	9.50	.80
M-100	Steel Ribbon, 100 meters, graduated to decimeters	17.00	

These tapes have the first meter in centimeters with the first decimeter in millimeters.

STEEL RIBBON CHAIN TAPES. VARA MEASURE ONLY

$\frac{1}{4}$ INCH WIDE, HEAVY STEEL RIBBON, DEEPLY ETCHED GRADUATIONS, DETACHABLE HANDLES AND FINE REEL
WITH NICKELED TRIMMINGS

No.		PRICE	POST
V-20	Steel Ribbon, 20 varas, graduated to tenths of a vara	\$5.00	\$0.40
V-30	Steel Ribbon, 30 varas, graduated to tenths of a vara	6.00	.45
V-50	Steel Ribbon, 50 varas, graduated to tenths of a vara	8.50	.60
V-100	Steel Ribbon, 100 varas, graduated to tenths of a vara	15.00	

METALLIC TAPES

Made of linen thread, interwoven with fine brass wire. They are $\frac{5}{8}$ inch wide, and in leather cases. The graduations are in 10ths or 12ths of a foot, as desired, on one side, and in links on the reverse side.



No. 782

No.		PRICE	POST
780	Metallic Tape, 33 feet, in 10ths or 12ths, and links	\$2.10	\$0.18
782	Metallic Tape, 50 feet, in 10ths or 12ths, and links	2.60	.20
783	Metallic Tape, 66 feet, in 10ths or 12ths, and links	3.00	.25
786	Metallic Tape, 100 feet, in 10ths or 12ths, and links	4.20	.30

We can furnish metallic tapes, Nos. 780 to 794, with metric or vara measure on reverse side, instead of links at an extra cost of one cent per foot.

METALLIC TAPES WITHOUT CASES

These tapes can be put into the leather cases when the original tape line is worn out.

No.		PRICE	POST
790	Metallic Tape, 33 feet, in 10ths or 12ths, and links	\$1.10	\$0.14
791	Metallic Tape, 50 feet, in 10ths or 12ths, and links	1.50	.16
792	Metallic Tape, 66 feet, in 10ths or 12ths, and links	1.80	.18
794	Metallic Tape, 100 feet, in 10ths or 12ths, and links	2.90	.20

STANDARD AMERICAN STEEL TAPES (SUPERIOR)

**$\frac{3}{8}$ INCH WIDE, ETCHED GRADUATIONS, IN LEATHER CASES
WITH NICKELED TRIMMINGS AND DOUBLE FOLDING
FLUSH HANDLE**

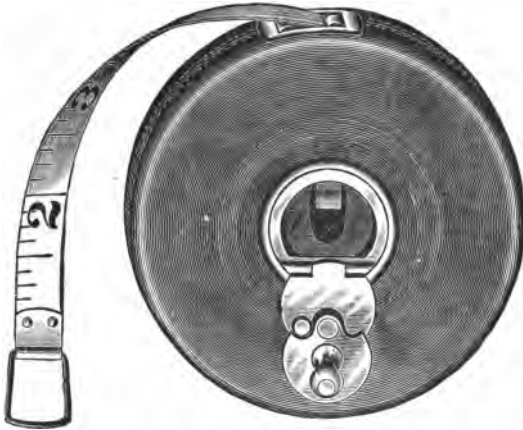

No. 796

No.		PRICE	Post
795	Steel Tape, 33 feet, in 10ths or 12ths, and links .	\$5.20	\$0.18
796	Steel Tape, 50 feet, in 10ths or 12ths, and links .	7.20	.20
797	Steel Tape, 66 feet, in 10ths or 12ths, and links .	9.20	.23
798	Steel Tape, 100 feet, in 10ths or 12ths, and links.	12.80	.30
799	Steel Tape, 200 feet, in 10ths or 12ths, and links.	24.00	.55

STANDARD AMERICAN STEEL TAPES

**$\frac{3}{8}$ INCH WIDE, IN LEATHER CASES WITH NICKELED TRIMMINGS
AND SINGLE FOLDING HANDLE**

No.		PRICE	Post
800	Steel Tape, 25 feet, in 10ths or 12ths, and links .	\$4.00	\$0.16
801	Steel Tape, 33 feet, in 10ths or 12ths, and links .	4.40	.18
802	Steel Tape, 50 feet, in 10ths or 12ths, and links .	6.40	.20
803	Steel Tape, 66 feet, in 10ths or 12ths, and links .	8.00	.23
804	Steel Tape, 75 feet, in 10ths or 12ths, and links .	9.60	.25
805	Steel Tape, 100 feet, in 10ths or 12ths, and links.	12.00	.30

STANDARD AMERICAN STEEL TAPES

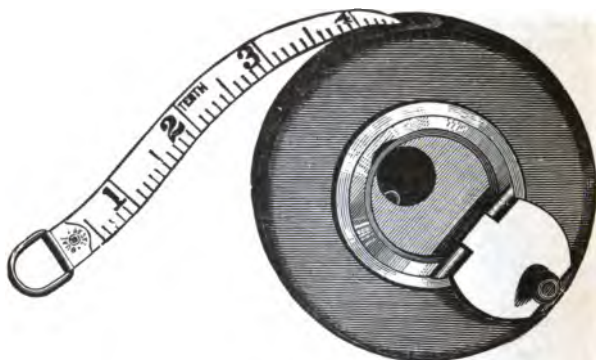

No. 802

THE "STAR" STEEL TAPES

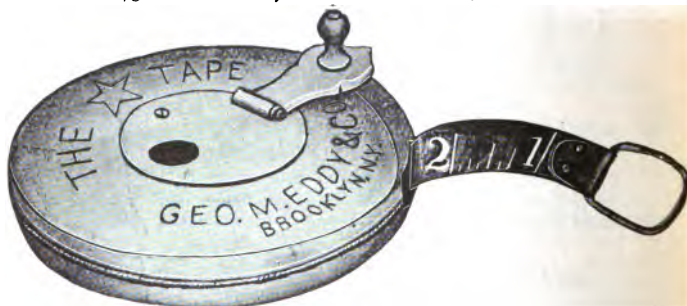
 $\frac{3}{8}$ INCH WIDE, IN NICKELED BRASS CASES

No. 810

No.		PRICE	POST
808	Steel Tape, 25 feet, in 10ths or 12ths, and links .	\$3.00	\$0.16
809	Steel Tape, 33 feet, in 10ths or 12ths, and links .	3.20	.18
810	Steel Tape, 50 feet, in 10ths or 12ths, and links .	3.60	.20
811	Steel Tape, 66 feet, in 10ths or 12ths, and links .	4.40	.25
812	Steel Tape, 75 feet, in 10ths or 12ths, and links .	4.80	.30
813	Steel Tape, 100 feet, in 10ths or 12ths, and links .	6.40	.35

Steel Tapes, Nos. 800 to 879, have etched graduations.

CHESTERMAN'S ENGLISH STEEL TAPES

 $\frac{3}{8}$ INCH WIDE, IN LEATHER CASES, FOLDING HANDLE

No.		Price	Post
815	Steel Tape, 33 feet, in 10ths or 12ths, and links .	\$5.20	\$0.18
816	Steel Tape, 50 feet, in 10ths or 12ths, and links .	7.20	.20
817	Steel Tape, 66 feet, in 10ths or 12ths, and links .	9.20	.23
819	Steel Tape, 100 feet, in 10ths or 12ths, and links .	12.80	.30

AMERICAN STEEL TAPES. PAINE'S PATTERN

 $\frac{1}{4}$ INCH WIDE, IN LEATHER CASES, FOLDING HANDLES

No. 830

No.		Price	Post
820	Steel Tape, 33 feet, in 10ths or 12ths, and links .	\$4.40	\$0.18
821	Steel Tape, 50 feet, in 10ths or 12ths, and links .	6.40	.23
822	Steel Tape, 66 feet, in 10ths or 12ths, and links .	8.00	.28
823	Steel Tape, 75 feet, in 10ths or 12ths, and links .	9.60	.30
824	Steel Tape, 100 feet, in 10ths or 12ths, and links .	12.00	.35

IN METAL CASES

830	Steel Tape, 25 feet, in 10ths or 12ths, and links .	\$2.80	\$0.16
831	Steel Tape, 33 feet, in 10ths or 12ths, and links .	3.60	.18
832	Steel Tape, 50 feet, in 10ths or 12ths, and links .	4.80	.23
833	Steel Tape, 66 feet, in 10ths or 12ths, and links .	6.40	.28
834	Steel Tape, 75 feet, in 10ths or 12ths, and links .	8.00	.30
835	Steel Tape, 100 feet, in 10ths or 12ths, and links .	9.60	.35

Tapes Nos. 821 to 824, and 832 to 835 (50 to 100 feet), are detachable from their cases and furnished with an extra handle, No. 841, and can be used as a chain tape.

Tapes Nos. 795 to 835 are graduated to feet, 10ths and 100ths of a foot, or to feet, inches and 8ths of an inch, as desired, on one side, and in links on the reverse side.

Tapes Nos. 820 to 835, with metric or vara measure on reverse side instead of links, at an extra cost of two and one half cents per foot.

EXTRAS FOR PAINE'S STEEL TAPES

No.		PRICE	POST
840	Compensating Handles, detachable, with graduated scale, per pair	\$2.00	\$0.14
841	Plain Finger Ring Handles, detachable, each40	.02
843	Pocket Thermometers, each85	.15

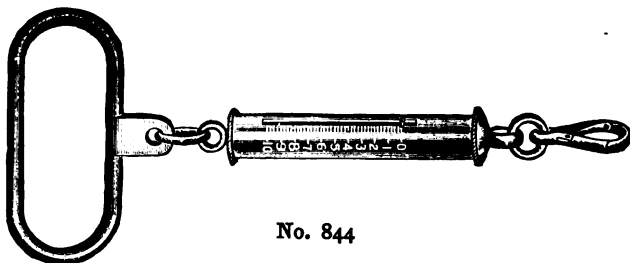

No. 844

No.		PRICE	POST
844	Spring Balance (for tension 0 to 10 lbs. or 0 to 20 lbs., as ordered), with handle and snap	\$2.50	\$0.15
845	Spring Balance and Level, with handle and snap	4.00	.17

GERMANIA STEEL TAPES

$\frac{1}{2}$ INCH WIDE, ON NICKELED BRASS FRAME WITH FOLDING HANDLE

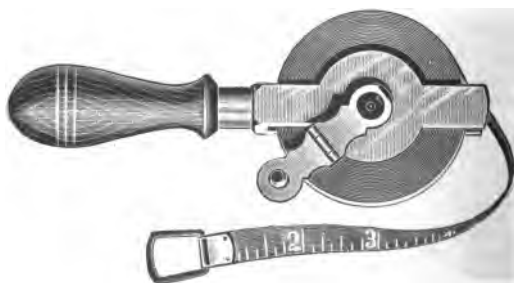

No. 851

GERMANIA STEEL TAPES

No.		PRICE	POST
850	Steel Tape, 33 feet, in 10ths or 12ths, and links .	\$5.00	\$0.20
851	Steel Tape, 50 feet, in 10ths or 12ths, and links .	6.00	.25
852	Steel Tape, 66 feet, in 10ths or 12ths, and links .	7.00	.30
853	Steel Tape, 100 feet, in 10ths or 12ths, and links .	10.00	.40
854A	Steel Tape, 150 feet, in 10ths or 12ths, and links .	15.00	.60
854B	Steel Tape, 200 feet, in 10ths or 12ths, and links .	20.00	
855	Steel Tape, 500 feet, in 10ths or 12ths, and meters	6.50	.25
858	Steel Tape, 100 feet, in 10ths or 12ths, and meters	12.00	.40
859A	Steel Tape, 150 feet, in 10ths or 12ths, and meters	17.00	.60
859B	Steel Tape, 200 feet, in 10ths or 12ths, and meters	22.00	

Tapes Nos. 850 to 854B are graduated to feet, 10ths and 100ths of a foot, or to feet, inches and 8ths of an inch, as desired, on one side and in links on the reverse side.

Tapes Nos. 855 and 859B have metric measure on the reverse side instead of links.

NICKEL PLATED TAPES

When desired, we will nickel plate our steel tapes, Nos. 795 to 835 and 850 to 859B, to protect from rust, at the following prices:

Feet	25	33	50	66	75	100	150	200
Each, \$0.90		1.00	1.50	1.75	1.75	2.00	2.50	3.00

POCKET STEEL TAPES

IN GERMAN SILVER CASES, WITH SPRING AND STOP

No.		PRICE	POST
860	Pocket Steel Tape, 3 feet, in 10ths or 12ths . .	\$0.80	\$0.19
863	Pocket Steel Tape, 6 feet, in 10ths or 12ths . .	1.00	.14
866	Pocket Steel Tape, 12 feet, in 10ths or 12ths . .	2.40	.16
870	Pocket Steel Tape, 6 feet, in 10ths one side and 12ths reverse side	1.25	.14
873	Pocket Steel Tape, 12 feet, in 10ths one side and 12ths reverse side	2.75	.16
875	Pocket Steel Tape, 3 feet, in 10ths or 12ths, and meter85	.13
877	Pocket Steel Tape, 6 feet, in 10ths or 12ths, and meters	1.25	.14
879	Pocket Steel Tape, 12 feet, in 10ths or 12ths, and meters	2.50	.16

PUNCH AND RIVETER, FOR REPAIRING TAPE LINES

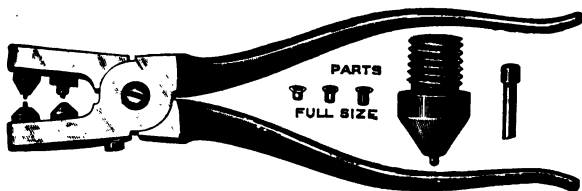

No. 88g

This punch cuts a clean hole in steel tapes of the usual thickness, and the eyelet is then inserted and quickly and neatly riveted. The punch is $7\frac{3}{4}$ inches long.

No.		PRICE	POST
885	Punch and Riveter, with eyelets	\$4.00	\$0.30
886	Extra eyelets, two lengths, two packages of 500 each length	1.25	.05

SUPPLEMENT
TO
THE FORTY SIXTH EDITION OF THE MANUAL
—
1912
—

The prices in this Catalogue may vary from time to time, on account of fluctuations in Market Rates.

This Price List supersedes all previous editions, and has been carefully revised and enlarged.

When ordering goods always state the edition of Manual, and the Catalogue number.

DRAWING INSTRUMENTS

TO guide the surveyor and engineer in the selection of drawing instruments, we here add a detailed description, with illustrations and prices of separate pieces and cases of different kinds in general use.

Those we first mention are of Alteneder manufacture and are the finest quality and finish and the best of American make. The German silver instruments, of German make, are the best of their kind of the several grades.

The superior quality of German instruments are the best that can be secured and in connection with our special grade are intended for use by engineers, architects, draftsmen, machinists and students in technical schools.

The cheaper German silver and nickel plated instruments are for schools in Elementary practice.

Those wishing special cases made up can select the pieces and we will make cases to suit, at an additional cost of from

\$2 to \$10, according to the size and quality of the cases, which are made of morocco or mahogany.

For the convenience of our customers, we will furnish any articles not on our list, but described in the catalogue of any American manufacturer or dealer in mathematical instruments, at catalogue prices.

SPECIAL NOTICE

MANY of our smaller instruments, such as drawing instruments pocket compasses, chains, tapes, small packages of paper and parts of large instruments, can be sent by mail securely packed, and at much lower rates than are charged by express companies. Packages not exceeding four pounds in weight can be sent in this way within the United States, Canada and Mexico at a cost of one cent per ounce.

In all cases where articles are to be sent by mail, the cash for postage as well as for the articles must accompany the order.

The postage required is mentioned in the second column of the Price List, and for articles worth more than one dollar the amount named for postage includes the cost of registry.

All articles can be registered at an extra cost of ten cents for each package besides regular postage. Packages for registry should not exceed four feet in length.

We are not responsible for articles lost or injured when sent by mail.

**ALTENEDERS PATENT JOINT GERMAN SILVER
AND STEEL DRAWING INSTRUMENTS**

WARRANTED GENUINE

The excellence of these instruments consists in the joints of the dividers being so constructed as to prevent any irregular motion when the legs are opened or closed, also in the general care with which the instruments are finished. All the pens are well made and pointed.

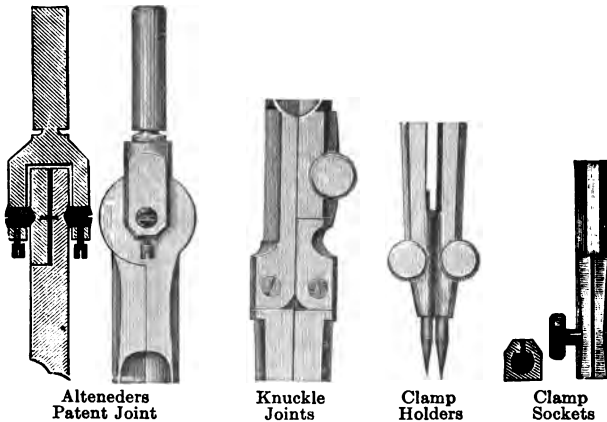

No.		PRICE	POST
1000	Plain Dividers, 3½ inch	\$2.25	\$0.12
1001	Plain Dividers, 4½ inch	2.50	.14
1002	Plain Dividers, 5 inch	2.50	.14
1006	Hairspring Dividers, 3½ inch	3.50	.12
1007	Hairspring Dividers, 4½ inch	3.75	.14
1008	Hairspring Dividers, 5 inch	4.00	.14
1015	Compasses, 3½ inch, with fixed needle and pen points	4.00	.14
1016	Compasses, 3½ inch, with fixed needle and pencil points	4.00	.14
1017	Compasses, 4½ inch, with fixed needle and pen points	4.50	.15
1018	Compasses, 4½ inch, with fixed needle and pencil points	4.50	.15



1001

1007

1017

1018

1022

ALTENEDERS PATENT JOINT GERMAN SILVER AND STEEL DRAWING INSTRUMENTS

No.		PRICE	POST
1019	Compasses, $5\frac{1}{2}$ inch, with fixed needle and pen points	\$5.00	\$0.15
1020	Compasses, $5\frac{1}{2}$ inch, with fixed needle and pencil points	5.00	.15
1021	Compasses, $3\frac{1}{2}$ inch, with fixed needle point, and pen and pencil points	6.00	.14
1022	Compasses, $3\frac{1}{2}$ inch, with fixed needle point, with hairspring, and pen and pencil points	7.50	.14
1023	Compasses, $4\frac{1}{2}$ inch, with fixed needle point, and pen and pencil points and lengthening bar	7.25	.15
1024	Compasses, $4\frac{1}{2}$ inch, with fixed needle point, with hairspring, and pen and pencil points and lengthening bar	8.75	.15
1025	Compasses, $5\frac{1}{2}$ inch, with fixed needle point, pen and pencil points and lengthening bar	7.50	.16
1026	Compasses, $5\frac{1}{2}$ inch, with fixed needle point, with hairspring, pen and pencil points and lengthening bar	9.00	.16
1035	Steelspring Bow Spacer, metal handle, $3\frac{1}{4}$ inch	1.75	.12
1036	Steelspring Bow Spacer, needle points, metal handle, $3\frac{1}{4}$ inch	2.50	.12
1037	Steelspring Bow Pen, needle point, metal handle, $3\frac{1}{4}$ inch	2.50	.12
1038	Steelspring Bow Pencil, needle point, metal handle, $3\frac{1}{4}$ inch	2.50	.12
1039	4 inch Self-adjusting needle point Bow Pen	4.00	.12
1040	4 inch Self-adjusting needle point Bow Pen and Pencil	5.00	.12



No. 1050

No.		PRICE	POST
1050	Drawing Pen, with spring blade, ebony handle, $4\frac{1}{4}$ inch	\$1.40	\$0.13
1051	Drawing Pen, with spring blade, ebony handle, 5 inch	1.65	.13
1052	Drawing Pen, with spring blade, ebony handle, $5\frac{1}{2}$ inch	1.90	.13

**ALTENEDERS PATENT JOINT GERMAN SILVER
AND STEEL DRAWING INSTRUMENTS**

No.		PRICE	POST
1053	Drawing Pen, with patent spring hinge, ebony handle, $4\frac{1}{4}$ inch	\$2.90	\$0.13
1054	Drawing Pen, with patent spring hinge, ebony handle, 5 inch	2.90	.13
1055	Drawing Pen, with patent spring hinge, ebony handle, $5\frac{1}{2}$ inch	2.90	.13
1060	Railroad Pen, ebony handle, 5 inch	3.50	.13
1062	Swivel Curve Pen, spring blade, hollow metal handle	2.00	.13
1064	Pricker, with removable needle point, ebony handle	1.00	.12
1066	Tubular nickel plated case, for leads15	.02

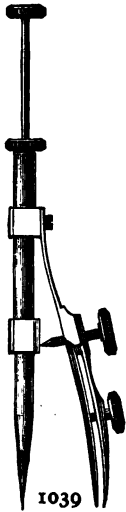

1039

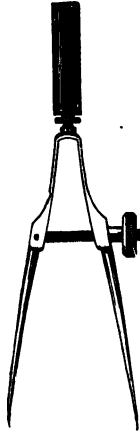

1035

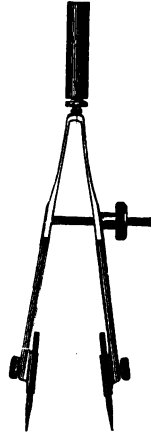

1036

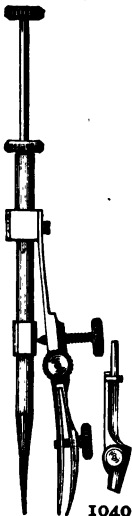

1040

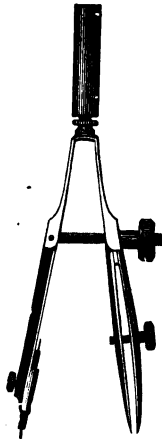

1037

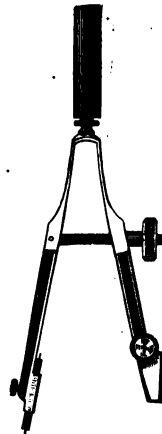

1038

ALTENEDERS PATENT JOINT DRAWING INSTRUMENTS IN MOROCCO CASE



No. 1077



No. 1070

ALTENEDERS PATENT JOINT DRAWING; INSTRUMENTS IN MOROCCO CASE

No.		PRICE	Post
1075	Morocco Case, containing: Compasses, No. 1025; Bow Pen, No. 1037; Drawing Pen, No. 1051; Box of Leads	\$13.25	\$0.20
1077	Morocco Case containing: Compasses, No. 1025; Bow Pen, No. 1037; Bow Pencil, No. 1038; Drawing Pen, No. 1051; Box of Leads	15.75	.22
1079	Morocco Case, containing: Hairspring Dividers, No. 1008; Compasses, No. 1025; Bow Spacer, No. 1035; Bow Pen, No. 1037; Bow Pencil, No. 1038; Drawing Pens, Nos. 1050 and 1051; Box of Leads . .	23.50	.25
1081	Morocco Case, containing: Hairspring Dividers, No. 1008; Compasses, No. 1026; Bow Spacer, No. 1035; Bow Pen No. 1037; Bow Pencil, No. 1038; Drawing Pens, Nos. 1050 and 1051; Box of Leads . .	25.00	.25
1083	Morocco Case, containing: Hairspring Dividers, No. 1008; Compasses, Nos. 1021 and 1024; Bow Spacer, No. 1035; Bow Pen, No. 1037; Bow Pencil, No. 1038; Drawing Pens, Nos. 1050 and 1051; Box of Leads	30.00	.30
1085	Folding Pocket Case, with flexible flaps, and containing same instruments as in set No. 1079	24.75	.25
1087	Folding Pocket Case, flexible flaps, containing Hairspring Dividers, No. 1008; Compasses, No. 1026; Bow Spacer, No. 1035; Bow Pen, No. 1037; Bow Pencil, No. 1038; Drawing Pens, Nos. 1050 and 1051; Box of Leads . .	26.25	0.25
1090	Empty Folding Pocket Case, with flexible flaps, and fitted to receive from five to twelve pieces of drawing instruments; price, according to size of case . .	\$3.00 to \$4.00	\$0.15 to \$0.30

Folding Pocket Cases furnished, instead of the usual Morocco Cases, with sets Nos. 1075 to 1081, at an extra cost of \$1.25, and with set No. 1083 at \$1.50 extra.

POLAR PLANIMETERS

By means of the Polar Planimeter a person can ascertain the area of any planimetric figure more accurately and in less time than the most experienced mathematician could calculate it.

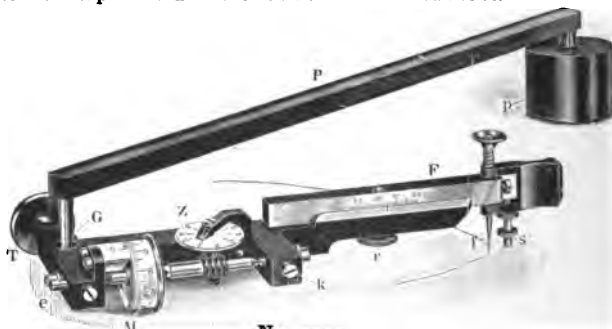

No. 1092

- | | | | |
|------|---|---------|--------|
| No. | | PRICE | POST |
| 1092 | Polar Planimeter, German silver, best quality, measuring up to 100 square inches, in mahogany case, with printed directions | \$16.50 | \$0.25 |

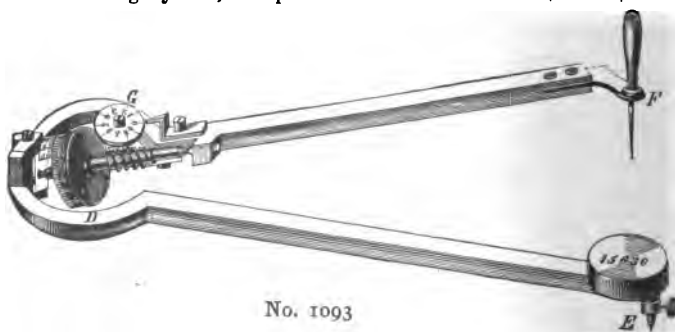

No. 1093

- | | | | |
|------|---|---------|--------|
| 1093 | Polar Planimeter, German silver, best quality, measuring up to 100 square inches, Swiss make, in morocco case, with printed directions | \$19.00 | \$0.25 |
| 1094 | Polar Planimeter, German silver, best quality, measuring up to 100 square inches. Also indicates square feet and square centimeters. Swiss make. In morocco case, with printed directions | 28.00 | .35 |

POLAR PLANIMETERS

No. 1095 Compensating Planimeter, German silver and brass; adjustable tracer arm fully graduated, improved pole weight, with directions, in case, German make . . . \$35.00

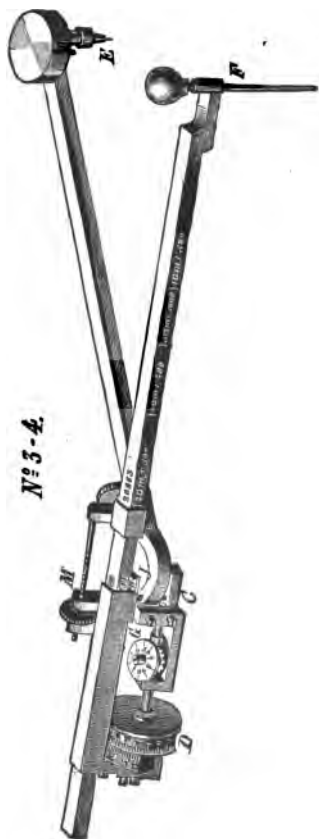

No. 1094

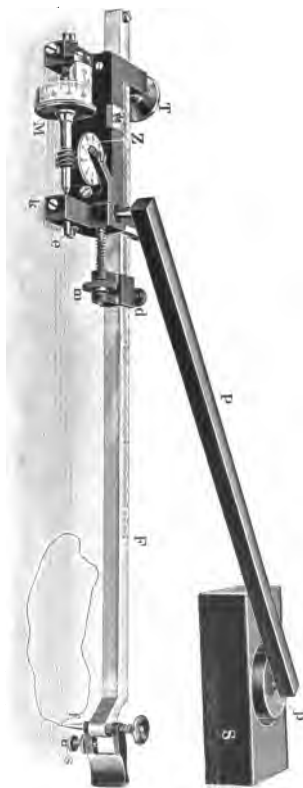

No. 1095

FINE DRAWING INSTRUMENTS

No.		PRICE	Post
1200	Plain Dividers, 3½ inch, with handle	\$0.70	\$0.02
1202	Plain Dividers, 6 inch, with handle	1.00	.14
1203	Plain Dividers, 6 inch, pivot joint handle (Superior)	1.25	.14
1206	Hairspring Dividers, 4¼ inch, with handle	1.20	.12
1208	Hairspring Dividers, 6 inch, with handle	1.75	.14
1209	Hairspring Dividers, 6 inch, pivot joint handle (Superior)	2.00	.14
1212	Pocket Dividers, 5 inch, with sheath	1.50	.14
1213	Three Legged Dividers, 5 inch, for taking off three points	2.75	.15



1203



1209



1212



1213

FINE DRAWING INSTRUMENTS

No.		PRICE	POST
1215	Compasses, 4¼ inch, with two steel points, pen, pencil and needle point	\$2.50	\$0.14
1216	Compasses, 4¼ inch, with pivot joint handle, pen, pencil and fixed needle point (Superior).	3.00	.14
1217	Compasses, 6 inch, with two steel points, pen, pencil and needle points and lengthening bar	3.00	.17
1218	Compasses, 6 inch, with pivot joint handle, pen, pencil, fixed needle point and lengthening bar (Superior).	4.00	.17



1218



1220



1225

FINE DRAWING INSTRUMENTS

No.		PRICE	Post
1220	Pocket Compasses, with folding points	\$5.00	\$0.14
1225	Proportional Dividers, 6½ inch, divided for lines	2.50	.16



No. 1232



No. 1234

FINE DRAWING INSTRUMENTS

No.		PRICE	Post
1226	Proportional Dividers, 7 inch, for lines and circles	\$3.25	\$0.17
1227	Proportional Dividers, 7½ inch, with rack movement and divided for lines and circles	5.20	.17
1230	Proportional Dividers, Swiss make, 5½ inch, divided for lines	8.00	.17
1231	Proportional Dividers, Swiss make, 8 inch, divided for lines and circles	10.00	.17
1232	Proportional Dividers, Swiss make, 8 inch, divided for lines and circles, and with rack and pinion movement	12.50	.20
1233	Proportional Dividers, Swiss make, divided for lines and circles, and with micrometer screw	15.00	.20
1234	Proportional Dividers, Swiss make, divided for lines, circles, planes, and solids, and with micrometer screw	16.50	.20
	Morocco Cases for Proportional Dividers:		
	To fit Dividers Nos. 1230, 1231	1.00	.14
	“ “ No. 1232	1.25	.14
	“ “ Nos. 1233, 1234	1.50	.16
1240	Beam Compass Furniture, with pen, pencil, fixed needle point and tangent adjustment, in case	5.50	.17
1241	Beam Compass Furniture, with pen, pencil, two needle points and micrometer adjustment, in case	6.00	.17



No. 1241

FINE DRAWING INSTRUMENTS

No.
1244Beam Compass Furniture, Swiss make, with two
steel points, pen, pencil and needle points, in
morocco case

PRICE Post

\$8.00 \$0.20



No. 1244

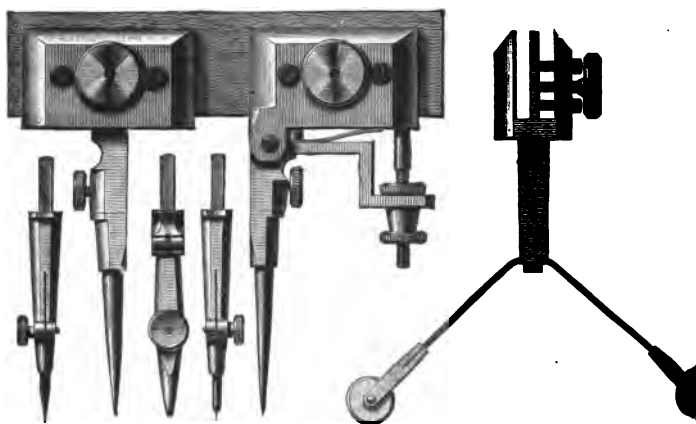

No. 1245

FINE DRAWING INSTRUMENTS

No.		PRICE	POST
1245	Beam Compass Furniture, Swiss make, with micrometer adjustment, two steel points, pen, pencil and needle points, and wheel attachment to stand alone; all in morocco case . .	\$13.00	\$0.30
1246	Hardwood Bars for No. 1244 Beam Compass, 24 30 36 48 inches long.		
	Each,	\$0.30	\$0.35
	Postage,	.10	.12
		.15	.20



1248	Map Measurer, registers inches to miles and centimeters to kilometers	2.00	.14
------	---	------	-----

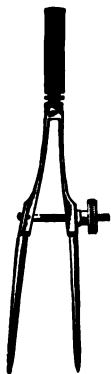

1250

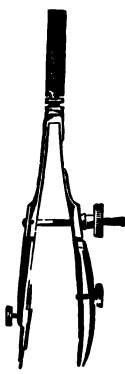

1251

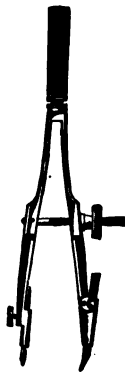

1252

1250	Steelspring Bow Spacer, metal handle, $3\frac{1}{2}$ inch	1.00	.12
1251	Steelspring Bow Pen, metal handle, $3\frac{1}{2}$ inch	1.35	.12
1252	Steelspring Bow Pencil, metal handle, $3\frac{1}{2}$ inch	1.35	.12

FINE DRAWING INSTRUMENTS



No. 1255

No.		PRICE	POST
1255	Set of three Steel Bows, Nos. 1250, 1251 and 1252, in morocco case	\$4.50	\$0.16
1260	Bow Spacer, with wheel adjustment, metal handle, 3½ inch	1.65	.12
1261	Bow Pen, with wheel adjustment, metal handle, 3½ inch	1.95	.12
1262	Bow Pencil, with wheel adjustment, metal handle, 3½ inch	1.95	.12
1265	Set of three Steel Bows, Nos. 1260, 1261 and 1262, in morocco case	6.40	.17
1268	Spring Bow Pen, with adjustable needle point for small circles	2.00	.12
1269	Spring Bow Pen, Swiss make, with adjustable point, for small circles	3.00	.12
1270	Spring Bow Pen, with pencil leg, and adjustable needle point for small circles	3.00	.13
1271	Spring Bow Pen and Pencil, Swiss make, with adjustable point, for small circles	4.00	.12
1275	Drawing Pen, without joint, ivory handle, 4½ inch40	.02
1277	Drawing Pen, without joint, ivory handle, 5½ inch45	.03
1280	Drawing Pen, with fine joint, ivory handle, 4½ inch60	.02

FINE DRAWING INSTRUMENTS

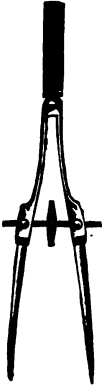

1260

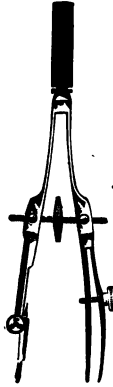

1261

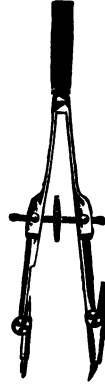

1262



1268



1270

FINE DRAWING INSTRUMENTS



1281



1285



1289

No.		PRICE	POST
1281	Drawing Pen, with fine joint, ivory handle, 5 inch	\$0.70	\$0.03
1282	Drawing Pen, with fine joint, ivory handle, 5½ inch80	.03
1285	Drawing Pen, with fine joint and pin, ivory handle, 4½ inch70	.02

FINE DRAWING INSTRUMENTS

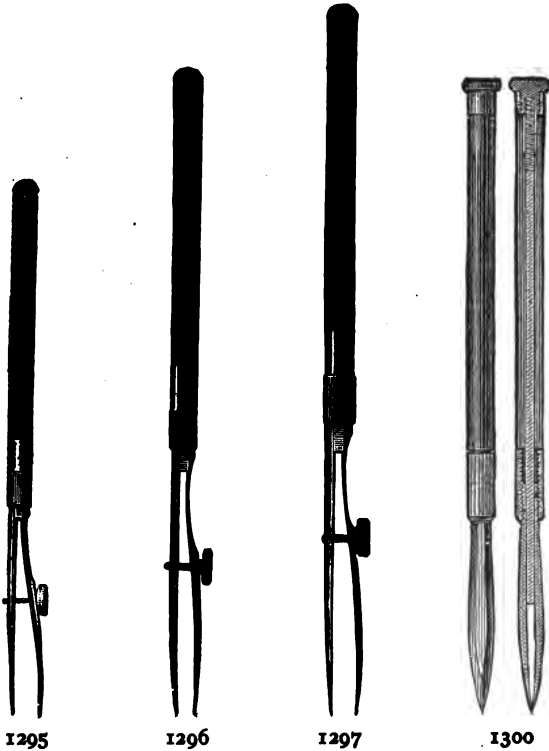

No.		PRICE	POST
1287	Drawing Pen, with fine joint and pin, ivory handle, 5 inch	\$0.80	\$0.03

FINE DRAWING INSTRUMENTS



1303



1308



1312

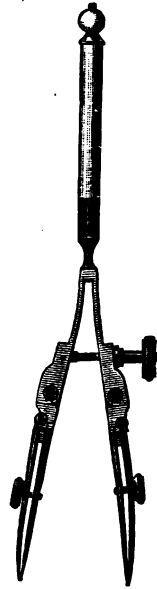

1314

No.	Description	Price	Post
1289	Drawing Pen, with fine joint and pin, ivory handle, $5\frac{1}{2}$ -6 inch	\$0.90	\$0.03
1295	Drawing Pen, Swiss make, with spring blade, ebony handle, $4\frac{1}{2}$ inch	1.10	.13
1296	Drawing Pen, Swiss make, with spring blade, ebony handle, 5 inch	1.20	.13

FINE DRAWING INSTRUMENTS



1316



1318



1320



1321

No.
1297

Drawing Pen, Swiss make, with spring blade,
ebony handle, 5½ inch

PRICE Post
\$1.35 \$0.13

FINE DRAWING INSTRUMENTS



1300



1303



1327



1329

No.		PRICE	POST
1300	Drawing Pen, without set screw, hollow metal handle, $5\frac{1}{2}$ inch	\$1.45	\$0.12
1303	Drawing Pen, Swedish pattern, ebony handle, 5 inch75	.03

FINE DRAWING INSTRUMENTS

No.		PRICE	POST
1304	Drawing Pen, Swedish pattern, ebony handle, 6 inch	\$0.85	\$0.03
1306	Drawing Pen, with German silver blades, for red ink, 5 inch70	.03
1308	Curve Pen, swivel blade, hollow metal handle, 5 inch	1.50	.12
1310	Drawing Pen, for heavy border lines, ivory handle, 5½ inch	2.00	.12
1312	Drawing Pen, Swiss make, with blades for broad lines, ebony handle; 6 inch	1.50	.13
1314	Railroad Pen, with joints, ivory handle, 5½ inch	2.25	.13
1316	Railroad Pen, Swiss make, without joints, ivory handle, 6 inch	2.75	.14
1318	Detail Pen, with broad blades, for heavy border lines, ebony handle, 6¼ inch	1.00	.13
1320	Border Pen, Swiss make, for broad line, ivory handle, 6½ inch	2.50	.14
1321	Railroad Pen and Border Pen to draw two parallel lines of same or different width or one broad line	3.50	.14
1322	Dotting Pen, one wheel, ivory handle, 5 inch	1.00	.12
1323	Dotting Pen, with six wheels, extra fine, in morocco case	3.75	.15

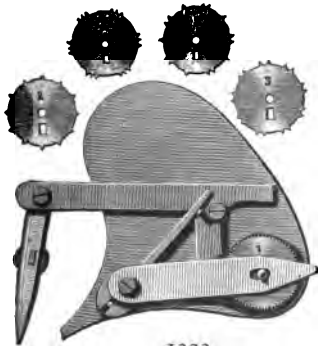

1323

The outer wheel is rolled on the edge of a ruler and turns the ratchet wheel, which causes the pen to move up and down. The flat point near the pen must slide on the paper.

1325	Railroad Curve Pen, swivel blades, hollow metal handle, 5¼ inch	4.25	.13
1327	Pricker, ivory handle, Swiss make.	1.00	.13
1329	Tracer, ivory handle, Swiss make.85	.02

**CASES OF SUPERIOR QUALITY FINE PIVOT JOINT
INSTRUMENTS OF BEST GERMAN MAKE**

GERMAN SILVER AND STEEL

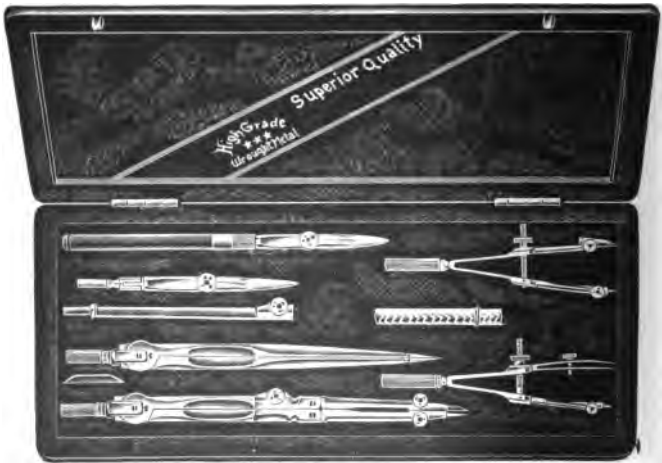

No. 1350

No.

PRICE POST

1350 Morocco Case, containing:

**Plain Dividers, 5 inch; Compasses, 5½ inch,
with fixed needle point, pen, pencil and
lengthening bar; Bow Pen; Bow Pencil;
Drawing Pen; Box of Leads**

\$12.00 \$0.20

CASES OF SUPERIOR QUALITY FINE PIVOT JOINT
INSTRUMENTS OF BEST GERMAN MAKE



No. 1351

No.		PRICE	POST
1351	Morocco Case, containing Hairspring Dividers, 5 inch; Compasses, 5½ inch, with fixed needle point, pen, pencil and lengthening bar; Bow Spacer; Bow Pen; Bow Pencil; two Drawing Pens; Box of Leads . .	\$14.50	\$0.24
1352	Folding Pocket Case, flexible flaps, containing: Hairspring Dividers, 5 inch; Compasses, 5½ inch, with fixed needle point, pen, pencil and lengthening bar; Bow Spacer; Bow Pen; Bow Pencil; two Drawing Pens; Box of Leads . .	15.00	.24

**CASES OF SUPERIOR QUALITY FINE PIVOT JOINT
INSTRUMENTS OF BEST GERMAN MAKE**

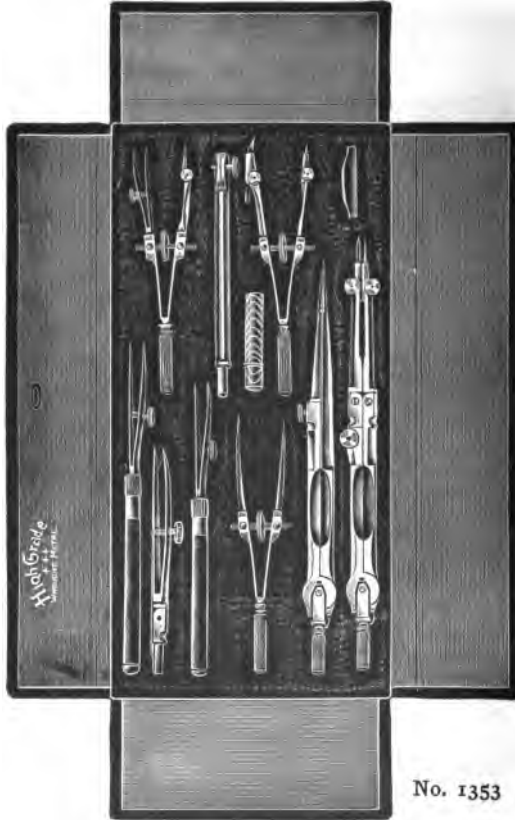

No. 1353

No.		PRICE	POST
1353	Folding Pocket Case, flexible flaps, containing: Hairspring Dividers, 5 inch; Compasses, 5½ inch, with fixed needle point, pen, pencil and lengthening bar; Bow Spacer, Bow Pen and Bow Pencil, each with central screw; two Drawing Pens; Box of Leads	\$17.00	\$0.25

CASES OF SUPERIOR QUALITY FINE PIVOT JOINT INSTRUMENTS OF BEST GERMAN MAKE



No. 1354

<p>No. 1354</p>	<p>Morocco Case, containing: Hairspring Dividers, 5 inch; Compasses, 5½ inch, with fixed needle point, pen, pencil and lengthening bar; Compasses, 3½ inch, with fixed needle and pen point; Compasses, 3½ inch, with fixed needle and pencil point; Bow Spacer; Bow Pen; Bow Pencil; three Drawing Pens; Box of Leads</p>	<p>PRICE Post \$20.00 \$0.28</p>
---------------------	---	---



No. 1355

No.		PRICE	POST
1355	Folding Pocket Case, flexible flaps, containing: Hairspring Dividers, 5 inch, Compasses, 5½ inch, equipped with micrometer attachment, pen, pencil and lengthening bar; Bow Pen and Pencil and Bow Spacer, each with circular spring and center screw. The bow pen and pencil also having our special micrometer attachment. Two drawing pens and box of leads. The pens of this set are fitted with patented cross joints to facilitate cleaning .	\$23.00	\$0.25
1356	Set complete as above but without micrometer attachment and with regular spring bows instead of spring bows with circular spring .	22.00	.25

The above sets are of the same quality as our 1350 series but have several improvements such as micrometer adjustment, patented cross joints to pens, improved pivot joint to heads of compasses and dividers.

CASES OF SPECIAL QUALITY GERMAN SILVER INSTRUMENTS



No. 1360

<p>No. 1360</p>	<p>Morocco Case, containing: Plain Dividers, 5 inch; Compasses, 5½ inch, with fixed needle point, pen, pencil and lengthening bar; Drawing Pen, 5 inch; Box of Leads</p>	<p>PRICE POST</p> <p>\$5.00 \$0.17</p>
---------------------	--	--



No. 1361

<p>1361</p>	<p>Morocco Case, containing: Plain Dividers, 5 inch; Compasses, 5½ inch, with fixed needle point, pen, pencil and lengthening bar; Bow Pen; Drawing Pen, 5 inch; Box of Leads</p>	<p>\$6.00 \$0.18</p>
-------------	---	----------------------

CASES OF SPECIAL QUALITY GERMAN SILVER INSTRUMENTS

No.		PRICE	POST
1362	Morocco Case, containing: Plain Dividers, 5 inch; Compasses, 5½ inch, with fixed needle point, pen, pencil and lengthening bar; Bow Pen; Bow Pencil; Drawing Pen, 5 inch; Box of Leads	\$7.00	\$0.20



No. 1363 $\frac{1}{2}$

1363	Morocco Case, containing: Plain Dividers, 5 inch; Compasses, 5½ inch, with fixed needle point, pen, pencil and length- ening bar; Bow Spacer; Bow Pen; Bow Pencil; Drawing Pen, 5 inch; Box of Leads	\$8.00	\$0.22
1364	Morocco Case, containing: Hairspring Dividers, 5 inch; Compasses, 5½ inch, with fixed needle point, pen, pencil and lengthening bar; Bow Spacer; Bow Pen; Bow Pencil; Drawing Pens, 4½ and 5 inches; Box of Leads	9.00	.24
1365	Morocco Case, containing: Plain Dividers, 5 inch; Compasses, 5½ inch, with fixed needle point, pen, pencil and lengthening bar; Compasses, 3½ inch, with two steel points, needle point, pen and pencil; Bow Spacer; Bow Pen; Bow Pencil; Drawing Pens, 4½ and 5 inches; Box of Leads	12.00	.26

CASES OF SPECIAL QUALITY GERMAN SILVER INSTRUMENTS



No. 1364

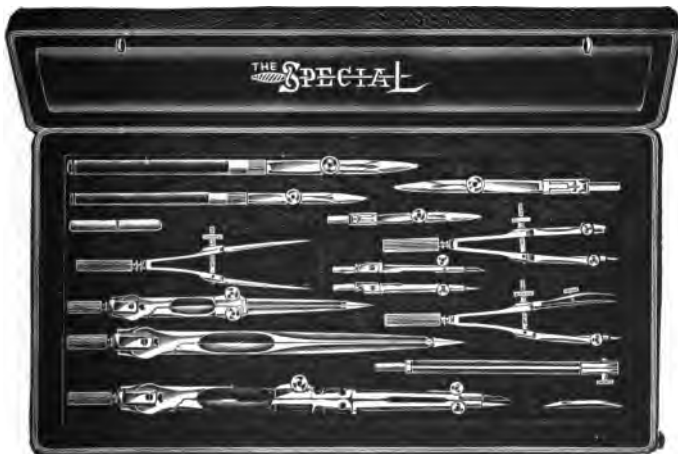

No. 1365

**CASES OF GERMAN SILVER INSTRUMENTS
FOR SCHOOL USE**



No. 1370

No.		PRICE	POST
1370	Leather Case, containing: Plain Dividers, 5 inch; Compasses, $5\frac{1}{2}$ inch, with fixed needle point, pen and pencil points and lengthening bar; Drawing Pen; Box of Leads	\$3.40	\$0.16



No. 1371

1371	Leather Case, containing: Compasses, $5\frac{1}{2}$ inch, with fixed needle point, pen and pencil points and lengthening bar; Bow Pen; Drawing Pen; Box of Leads . . .	\$3.75	.16
------	---	--------	-----

CASES OF GERMAN SILVER INSTRUMENTS



No. 1372

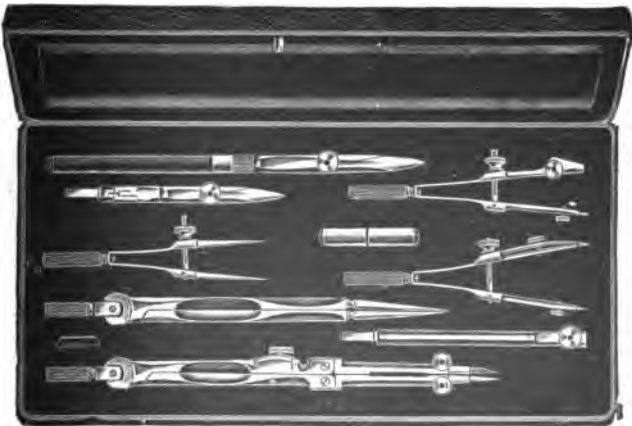

No. 1374

CASES OF GERMAN SILVER INSTRUMENTS

No.		PRICE	POST
1872	Leather Case, containing: Plain Dividers, 5 inch; Compasses, 5½ inch, with fixed needle point, pen and pencil points and lengthening bar; Bow Pen; Drawing Pen; Box of Leads	\$4.25	\$0.17
1873	Leather Case, containing: Plain Dividers, 5 inch; Compasses, 5½ inch, with fixed needle point, pen and pencil points and lengthening bar; Bow Pen; Bow Pencil; Drawing Pen; Box of Leads	5.00	.18
1874	Leather Case, containing Plain Dividers, 5 inch; Compasses, 5½ inch, with fixed needle point, pen, pencil and lengthening bar; Bow Spacer; Bow Pen; Bow Pencil; Drawing Pen; Box of Leads	5.75	.20

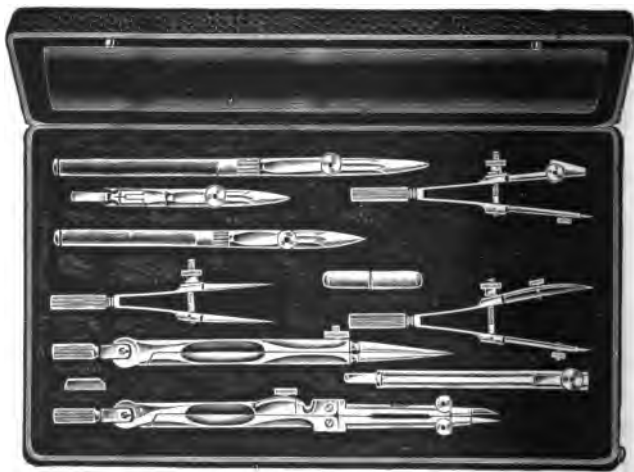

No. 1375

CASES OF GERMAN SILVER INSTRUMENTS

No.		PRICE	POST
1375	Leather Case, containing: Hairspring Dividers, 5 inch; Compasses, 5½ inch, with fixed needle point, pen and pencil points and lengthening bar; Bow Spacer; Bow Pen; Bow Pencil; two Drawing Pens; Box of Leads	\$6.75	\$0.20
1376	Leather Case, containing: Plain Dividers, 5 inch; Compasses, 5½ inch, with fixed needle point, pen and pencil points and lengthening bar; Compasses, 3½ inch, with two steel points, needle point, pen and pencil points; Bow Spacer; Bow Pen; Bow Pencil; two Drawing Pens; Box of Leads . .	8.50	.24

CASES OF NICKEL PLATED DRAWING INSTRUMENTS IN LEATHERETTE CASES

FOR BEGINNERS

No.		PRICE	POST
1390	Case, containing: Compasses, 4½ inch, with pen and pencil points; Drawing Pen; Box of Leads; Protractor, Ruler and Triangle	\$1.65	\$0.15
1391	Case, containing: Plain Dividers, 4 inch; Compasses, 4½ inch, with pen and pencil points; Drawing Pen; Box of Leads; Protractor, Ruler and Triangle	1.40	.17



No. 1392

1392	Case, containing: Plain Dividers, 4 inch; Compasses, 4½ inch, with pen and pencil points and lengthening bar; Spring Bow Pen; Drawing Pen; Box of Leads; Protractor, Ruler and Triangle	2.25	.20
------	--	------	-----

PROTRACTORS
EXTRA FINE GERMAN SILVER PROTRACTORS
OF BEST GERMAN MAKE

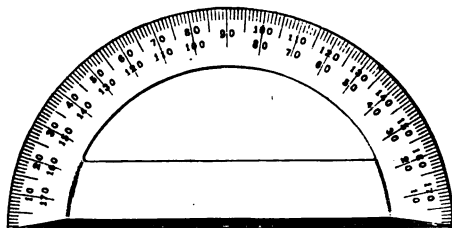

No. 1442

No.	Description	PRICE	Post
1440	Protractor, half circle, 4 inch, beveled edge, center on outer edge, divided to 1 degree . . .	\$1.00	\$0.14
1441	Protractor, half circle, 5 inch, divided to 1/2 degrees . . .	1.50	.14
1442	Protractor, half circle, 6 inch, divided to 1/2 degrees . . .	2.10	.16
1443	Protractor, half circle, 6 inch, divided to 1/4 degrees . . .	2.60	.16
1444	Protractor, half circle, 7 inch, divided to 1/2 degrees . . .	3.00	.16

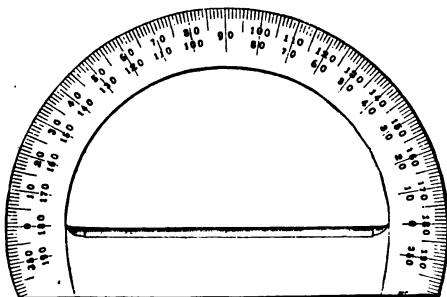

No. 1446

1445	Protractor, half circle, 5 inch, beveled edge, center on inner edge, divided to 1/2 degrees . . .	1.75	.14
1446	Protractor, half circle, 6 inch, divided to 1/2 degrees . . .	2.40	.16
1447	Protractor, half circle, 6 inch, divided to 1/4 degrees . . .	2.90	.16

EXTRA FINE GERMAN SILVER PROTRACTORS

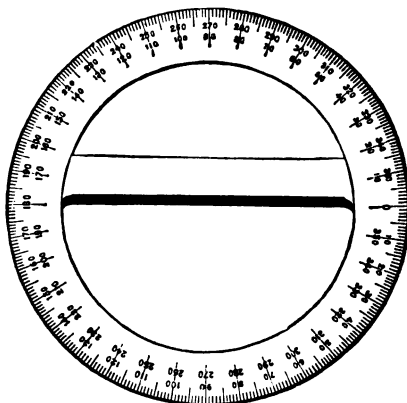

No. 1450

No.		PRICE	POST
1450	Protractor, whole circle, 5 inch, divided to $\frac{1}{2}$ degrees	\$3.50	\$0.18

EXTRA FINE GERMAN SILVER PROTRACTORS
WITH ARM AND WITHOUT VERNIER

No.		PRICE	POST
1454	Protractor, half circle, 6 inch, with horn center and 6 inch movable arm, divided to $\frac{1}{2}$ degrees	\$8.50	\$0.20
1455	Protractor, half circle, 7 inch, with horn center and $6\frac{1}{2}$ inch movable arm, divided to $\frac{1}{2}$ degrees	10.00	.22

EXTRA FINE GERMAN SILVER PROTRACTORS
WITH ARM AND WITHOUT VERNIER

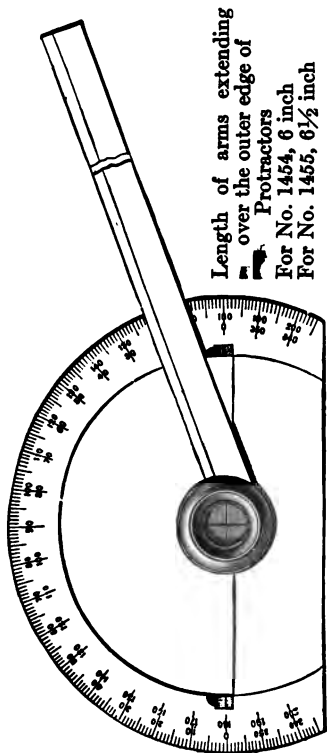

Length of arms extending
over the outer edge of
Protractors
For No. 1454, 6 inch
For No. 1455, 6½ inch

No. 1455

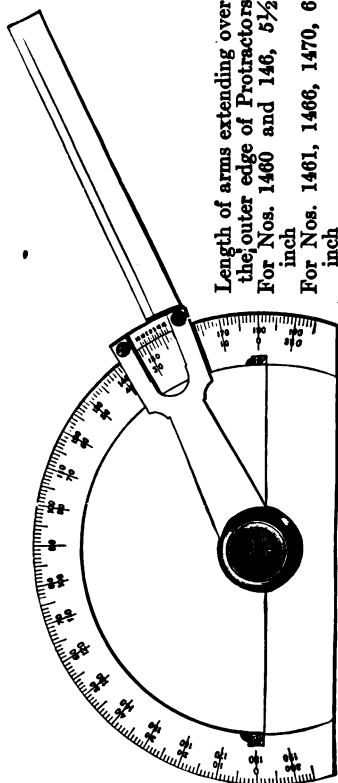

Length of arms extending over
the outer edge of Protractors
For Nos. 1460 and 146, 5½
inch
For Nos. 1461, 1466, 1470, 6
inch
For Nos. 1462, 1467, 1473, 6½ inch

No. 1461

EXTRA FINE GERMAN SILVER PROTRACTORS WITH ARM AND VERNIER

No.		PRICE	POST
1460	Protractor, half circle, $5\frac{1}{2}$ inch, with horn center and movable arm, divided to $\frac{1}{2}$ degrees, vernier reading to 3 minutes	\$10.00	\$0.20
1461	Protractor, half circle, 8 inch, divided to $\frac{1}{4}$ degrees, vernier to 1 minute	14.00	.25
1462	Protractor, half circle, 10 inch, divided to $\frac{1}{4}$ degrees, vernier to 1 minute	17.00	.35
1465	Protractor, whole circle, $5\frac{1}{2}$ inch, with horn center and movable arm, divided to $\frac{1}{2}$ degrees, vernier reading to 3 minutes	14.00	.25
1466	Protractor, whole circle, 8 inch, divided to $\frac{1}{4}$ degrees, vernier to 1 minute	16.00	.35
1467	Protractor, whole circle, 10 inch, divided to $\frac{1}{4}$ degrees, vernier to 1 minute	20.00	.50
1470	Protractor, whole circle, 8 inch, with horn center and movable arm, divided to $\frac{1}{4}$ degrees, vernier to 1 minute, with clamp and tangent to arm	20.00	.25
1473	Protractor, whole circle, 8 inch, with horn center and movable arm, divided to $\frac{1}{4}$ degrees, vernier to 1 minute, with clamp and tangent to arm and magnifying lens	23.50	.40

MAHOGANY CASES FOR PROTRACTORS

No.		PRICE	POST
1476	Case for Protractors Nos. 1454, 1455, 1460	\$1.75	\$0.25
1477	Case for Protractors Nos. 1461, 1462, 1465, 1470	2.00	.35
1478	Case for Protractors Nos. 1466, 1467, 1473	2.50	.45

LIMB PROTRACTOR

BRONZE HEAD, STEEL BLADE, NICKEL PLATED, VERNIER
TO ONE MINUTE

Made by W. & L. E. Gurley

No.		PRICE
1480	Limb Protractor, with blade 24 inch	\$8.00
1481	Limb Protractor, with blade 30 inch	8.75
1482	Limb Protractor, with blade 36 inch	9.50
1483	Limb Protractor, with blade 42 inch	10.25
1484	Limb Protractor, with blade 48 inch	11.50

LIMB PROTRACTOR

BRONZE HEAD, STEEL BLADE, VERNIER TO ONE MINUTE

Made by W. & L. E. Gurley

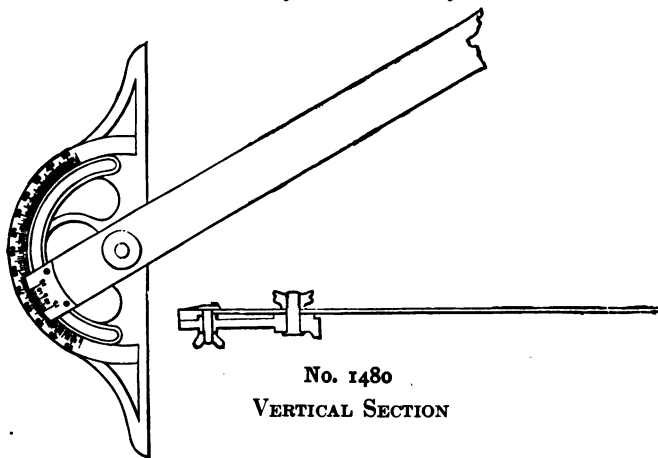

No. 1480

VERTICAL SECTION

DRAFTSMAN'S PROTRACTOR

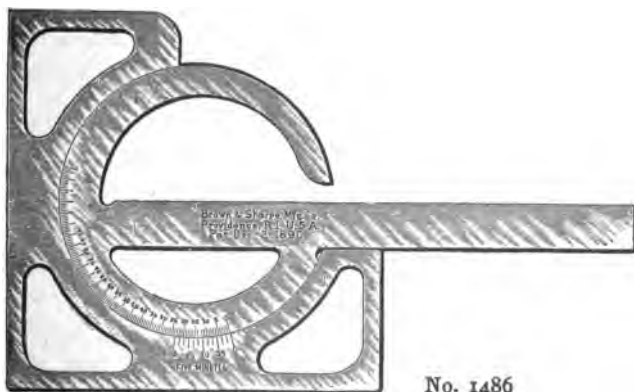

No. 1486

DRAFTSMAN'S PROTRACTOR

No.		PRICE	POST
1486	Steel Protractor, divided to 1 degree, vernier to 5 minutes, 8½ inch blade. It is used with the T rule or straight edge. Very convenient in dividing circles, transferring angles, laying off angles each side of a line without resetting. In morocco case	\$7.75	\$0.35

CROZET PROTRACTOR

Made by W. & L. E. Gurley

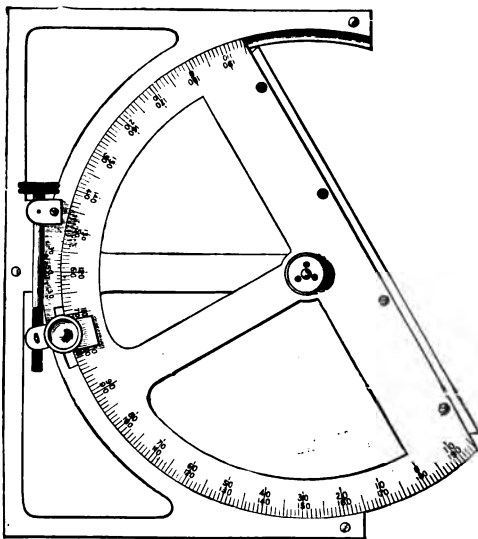

No. 1488

No.		PRICE
1488	Crozet Protractor, German Silver, 8 inch, half circle, half degrees, vernier to 1 minute. In mahogany case	\$40.00

The Crozet Protractor we can recommend as the best among the high grade Protractors.

It is used with the T rule or straight edge. The feather edge is set to the starting point and lines produced without puncturing the paper.

DUFFIELD PROTRACTOR

Made by W. & L. E. Gurley

Made of transparent celluloid, with two parallel scales of twenty parts to the inch, so that the zero line can be set parallel to meridian lines drawn on the paper.

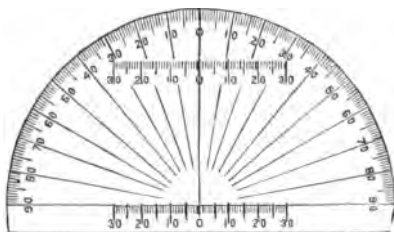

No. 1490

No.		PRICE	POST
1490	Protractor, half circle, 6 inch, divided to 1/2 degrees	\$3.00	\$0.14
1492	Protractor, half circle, 9 inch, divided to 1/2 degrees	3.50	.17
1494	Protractor, half circle, 12 inch, divided to 1/4 degrees	4.00	.20

GERMAN SILVER PROTRACTORS, FLAT EDGE

No.		PRICE	POST
1500	German Silver Protractor, 4 inch, half circle, half degrees	\$0.40	\$0.03
1502	German Silver Protractor, 5 inch, half circle, half degrees60	.04
1503	German Silver Protractor, 6 inch, half circle, half degrees80	.06

BRASS PROTRACTORS, FLAT EDGE

No.		PRICE	POST
1515	Brass Protractor, 3 1/2 inch, half circle, whole degrees	\$0.10	\$0.02
1516	Brass Protractor, 4 1/4 inch, half circle, whole degrees25	.03
1517	Brass Protractor, 4 inch, half circle, half degrees35	.03
1518	Brass Protractor, 5 inch, half circle, half degrees50	.04
1519	Brass Protractor, 6 inch, half circle, half degrees65	.06

OPAQUE WHITE CELLULOID PROTRACTORS

CENTER AT INNER EDGE

No.		PRICE	POST
1525W	Celluloid Protractor, 6 inch, half circle, beveled edge, half degrees	\$2.75	\$0.16
1526W	Celluloid Protractor, 8 inch, half circle, beveled edge, half degrees	3.50	.18
1527W	Celluloid Protractor, 6 inch, whole circle, beveled edge, half degrees	3.50	.20
1528W	Celluloid Protractor, 8 inch, whole circle, beveled edge, half degrees	4.50	.22

TRANSPARENT CELLULOID PROTRACTORS

No.		PRICE	POST
1532	Celluloid Protractor, 6 inch, half circle, beveled edge, half degrees	\$2.75	\$0.16
1533	Celluloid Protractor, 8 inch, half circle, beveled edge, half degrees	3.50	.18
1535	Celluloid Protractor, 6 inch, whole circle, beveled edge, half degrees	3.50	.20
1536	Celluloid Protractor, 8 inch, whole circle, beveled edge, half degrees	4.50	.22

TRANSPARENT CELLULOID PROTRACTORS, FLAT

No.		PRICE	POST
1541C	Protractor, 5 inch, half circle, half degrees	\$0.45	\$0.03
1542C	Protractor, 6 inch, half circle, half degrees60	.04
1543C	Protractor, 7 inch, half circle, half degrees75	.05
1544C	Protractor, 8 inch, half circle, half degrees	1.20	.16
1548C	Protractor, 6 inch, whole circle, half degrees	1.50	.16
1549C	Protractor, 8 inch, whole circle, half degrees	2.25	.18

RAILROAD CURVE PROTRACTORS

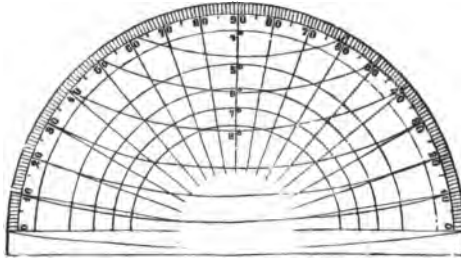

No. 1551A

No.		PRICE	POST
1551A	Railroad Curve Protractor, of transparent celluloid, 8 inch, half circle, half degrees, with circular curves from $\frac{1}{2}$ degree to 8 degrees, to a scale of 400 feet to the inch.	\$2.75	\$0.16
1551B	Railroad Curve Protractor, of transparent celluloid, 10 inch, half circle, half degrees, with circular curves 1° , $1\frac{1}{2}^\circ$, 2° , $2\frac{1}{2}^\circ$, 3° , $3\frac{1}{2}^\circ$, 4° , 5° , 6° , 7° , 8° , 10° , 12° , 14° , 16° , 18° , 20° , to a scale of 100 feet to the inch	3.25	.20

PAPER PROTRACTORS

No.		PRICE	POST
1552	Protractor, on Bristol Board, 5 inch, half circle, half degrees	\$0.10	\$0.02
1553	Protractor, on Bristol Board, 6 inch, half circle, half degrees15	.02
1554	Protractor, on Bristol Board, 5 inch, half circle, half degrees, and diagonal scale to inches and 100ths, and millimeters15	.02
1555	Protractor, on Bristol Board, 8 inch, whole circle, half degrees.20	.04
1556	Protractor, on Bristol Board, 13 inch, whole circle, quarter degrees40	.07
1558	Protractor, on Drawing Paper, 13 inch, whole circle, quarter degrees30	.06
1559	Protractor, on Tracing Paper, 13 inch, whole circle, quarter degrees25	.06

SCALES IVORY PROTRACTOR SCALES

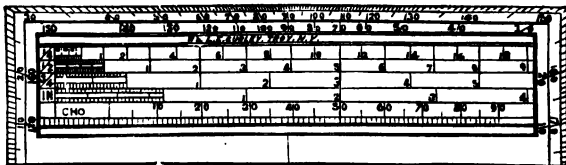

No. 1560 FRONT VIEW

No.		PRICE	POST
1560	Ivory Rectangular Protractor, 6 inches long, $1\frac{3}{4}$ inches wide, with scales as follows: front sides divided around edges from 0 to 180 degrees in single degrees, scales of $\frac{1}{4}$, $\frac{1}{2}$, $\frac{3}{4}$ and 1 inch to the foot, and scale of chords. Reverse side scales of 30, 35, 40, 45, 50 and 60 parts to the inch, scale of chords and diagonal scale of inches and 100ths	\$1.75	\$0.14
1561	Ivory Rectangular Protractor, 6 inches long by $1\frac{3}{4}$ inches wide, with scales as follows: front side, the edge divided into single degrees from 0 to 180 degrees, scales of $\frac{1}{8}$, $\frac{1}{4}$, $\frac{3}{8}$, $\frac{1}{2}$, $\frac{5}{8}$, $\frac{3}{4}$, $\frac{7}{8}$ and 1 inch to the foot, and scale of chords. On the reverse side, scales of 30, 35, 40, 45, 50 and 60 parts to the inch, scale of chords and diagonal scale of 100ths	2.00	.14
1563	Ivory Rectangular Protractor, 6 inches long by 2 inches wide, with scales as follows: front side, the edge divided in whole degrees from 0 to 180 degrees, scales of $\frac{1}{8}$, $\frac{1}{4}$, $\frac{3}{8}$, $\frac{1}{2}$, $\frac{5}{8}$, $\frac{3}{4}$, $\frac{7}{8}$, 1, $1\frac{1}{8}$, $1\frac{1}{4}$, $1\frac{3}{8}$, $1\frac{1}{2}$ inches to the foot, scale of chords, and line of 40 parts on lower edge. On the reverse side, scales of 30, 35, 40, 45, 50 and 60 parts to the inch, and diagonal scale of 100ths	4.35	.15
1564	Ivory Rectangular Protractor, 6 inches long by $2\frac{1}{2}$ inches wide, with scales as follows: front side, the edge divided in $\frac{1}{2}$ degrees from 0 to 180 degrees, scales of $\frac{1}{8}$, $\frac{1}{4}$, $\frac{3}{8}$, $\frac{1}{2}$, $\frac{5}{8}$, $\frac{3}{4}$, $\frac{7}{8}$, 1, $1\frac{1}{8}$, $1\frac{1}{4}$, $1\frac{3}{8}$, $1\frac{1}{2}$ inches to the foot, scale of chords, and scale of 40 parts on the lower edge. Reverse side, scales of 10, 15, 20, 25, 30, 35, 40, 45, 50 and 60 parts to the inch, and diagonal scale of 100ths	5.50	.15

FLAT BOXWOOD AND IVORY SCALES

No.		PRICE	Post
1570	Boxwood Protractor, 6 inches long, $1\frac{3}{4}$ inches wide, divided to whole degrees, with scales $\frac{1}{4}$, $\frac{1}{2}$, $\frac{3}{4}$, 1 inch, diagonal scale and scale of chords	\$0.35	\$0.03
1572	Boxwood Scale, 6 inch, diagonal and chain scales	.15	.02



No. 1573

No.		PRICE	Post
1573	Ivory Scale, 6 inch, with diagonal and chain scales	\$0.85	\$0.03
1575	Boxwood Sector Scale, 6 inch, opens to 12 inch	1.00	.14
1576	Ivory Sector Scale, 6 inch, opens to 12 inch	2.25	.14
1577	Boxwood Scale, 6 inch, divided $\frac{1}{8}$, $\frac{1}{4}$, $\frac{1}{2}$, 1 inch to the foot	.50	.03

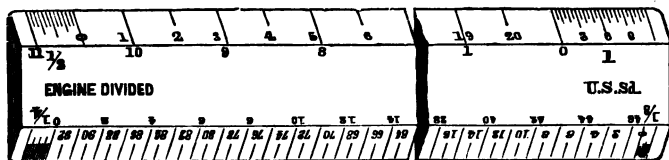

No.		PRICE	Post
1578	Boxwood Scale, 12 inch, divided $\frac{1}{8}$, $\frac{1}{4}$, $\frac{1}{2}$, 1 inch to the foot	\$0.75	\$0.06
1579	Boxwood Scale, 18 inch, divided $\frac{1}{8}$, $\frac{1}{4}$, $\frac{1}{2}$, 1 inch to the foot	1.50	.18
1580	Boxwood Scale, 24 inch, divided $\frac{1}{8}$, $\frac{1}{4}$, $\frac{1}{2}$, 1 inch to the foot	2.00	.22
1583	Boxwood Scale, 6 inch, divided $\frac{3}{8}$, $\frac{3}{4}$, $1\frac{1}{2}$, 3 inches to the foot	.50	.03
1584	Boxwood Scale, 12 inch, divided $\frac{3}{8}$, $\frac{3}{4}$, $1\frac{1}{2}$, 3 inches to the foot	.75	.06
1585	Boxwood Scale, 18 inch, divided $\frac{3}{8}$, $\frac{3}{4}$, $1\frac{1}{2}$, 3 inches to the foot	1.50	.12

FLAT BOXWOOD AND IVORY SCALES

No.		PRICE	Post
1586	Boxwood Scale, 24 inch, divided $\frac{3}{8}$, $\frac{3}{4}$, $1\frac{1}{2}$, 3 inches to the foot	\$2.00	\$0.22
1590	Boxwood White Edge Scale, 6 inch, divided $\frac{1}{8}$, $\frac{1}{4}$, $\frac{1}{2}$, 1 inch to the foot	.75	.03
1592	Boxwood White Edge Scale, 12 inch, divided $\frac{1}{8}$, $\frac{1}{4}$, $\frac{1}{2}$, 1 inch to the foot	1.25	.16
1594	Boxwood White Edge Scale, 6 inch, divided $\frac{3}{8}$, $\frac{3}{4}$, $1\frac{1}{2}$, 3 inches to the foot	.75	.03
1595	Boxwood White Edge Scale, 12 inch, divided $\frac{3}{8}$, $\frac{3}{4}$, $1\frac{1}{2}$, 3 inches to the foot	1.25	.16
1604	Boxwood Scale, 12 inch, with the following scales, the graduation of which are all brought to the edge: $\frac{1}{8}$, $\frac{1}{8}$, $\frac{3}{8}$, $\frac{1}{4}$, $\frac{3}{8}$, $\frac{1}{2}$, $\frac{5}{8}$, $\frac{3}{4}$, $\frac{7}{8}$, 1, $1\frac{1}{4}$, $1\frac{1}{2}$, $1\frac{3}{4}$, 2, $2\frac{1}{2}$, and 3 inches to the foot, the first division of each scale subdivided into 12 parts	.90	.06
1610	Boxwood School Rule, 12 inch, divided $\frac{1}{8}$ and $\frac{1}{8}$ of an inch	.15	.03
1611	Boxwood School Rule, 18 inch, divided $\frac{1}{8}$ of an inch, and with inlaid brass edges	.35	.10
1612	School Rule, 12 inch, beveled edges, divided $\frac{1}{8}$ of an inch and millimeters	.25	.05
1613	School Rule, 18 inch, beveled edges, divided $\frac{1}{8}$ of an inch and millimeters	.35	.10

FLAT BOXWOOD CHAIN SCALES

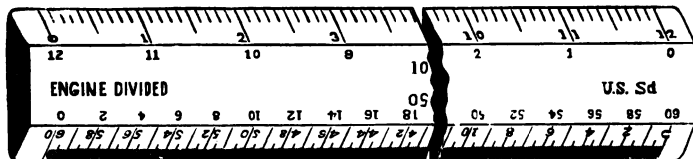

No. 1618

No.		PRICE	POST
1615	Boxwood Scale, 6 inch, divided 10 and 50 parts to the inch	\$0.50	\$0.03
1616	Boxwood Scale, 6 inch, divided 20 and 40 parts to the inch	.50	.03
1617	Boxwood Scale, 6 inch, divided 30 and 60 parts to the inch	.50	.03
1618	Boxwood Scale, 12 inch, divided 10 and 50 parts to the inch	.75	.06
1619	Boxwood Scale, 12 inch, divided 20 and 40 parts to the inch	.75	.06
1620	Boxwood Scale, 12 inch, divided 30 and 60 parts to the inch	.75	.06
1627	Boxwood Offset Scales, 2 inch, divided like Nos. 1615 to 1617, each	.40	.02
1629	Boxwood White Edge Scale, 6 inch, divided 10 and 50 parts to the inch	.75	.03
1630	Boxwood White Edge Scale, 6 inch, divided 20 and 40 parts to the inch	.75	.03
1631	Boxwood White Edge Scale, 6 inch, divided 30 and 60 parts to the inch	.75	.03
1632	Boxwood White Edge Scale, 12 inch, divided 10 and 50 parts to the inch	1.25	.16
1633	Boxwood White Edge Scale, 12 inch, divided 20 and 40 parts to the inch	1.25	.16
1634	Boxwood White Edge Scale, 12 inch, divided 30 and 60 parts to the inch	1.25	.16
1641	White Edge Offset Scales, 2 inch, divided like Nos. 1632 to 1634, each	.70	.02

FLAT METALLIC CHAIN SCALES

A superior article, our own make, made of brass, and nickel plated.
Divided on beveled edges.

No.		PRICE	POST
1645	Flat Metal Scale, 12 inch, divided 10 and 50 parts to the inch	\$3.00	\$0.16
1646	Flat Metal Scale, 12 inch, divided 20 and 40 parts to the inch	3.00	.16
1647	Flat Metal Scale, 12 inch, divided 30 and 60 parts to the inch	3.75	.16
1648	Flat Metal Scale, 12 inch, divided 80 and 100 parts to the inch	5.00	.16
1649	Flat Metal Scale, 12 inch, divided 100 and 500 parts to the foot	3.00	.16
1650	Flat Metal Scale, 30 centimeters, divided to millimeters and half millimeters	3.75	.16

TRIANGULAR BOXWOOD SCALES

OF BEST QUALITY, FOR ARCHITECTS

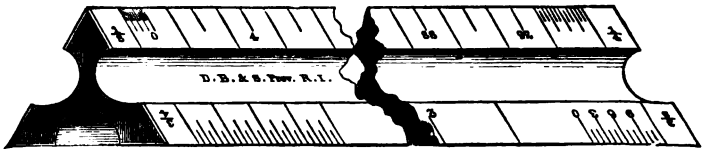

No. 1656

No.		PRICE	POST
1655	Triangular Boxwood Scale 6 inch, divided $\frac{3}{8}$, $\frac{1}{6}$, $\frac{1}{8}$, $\frac{1}{4}$, $\frac{3}{8}$, $\frac{1}{2}$, $\frac{3}{4}$, 1, $1\frac{1}{2}$ and 3 inches to the foot, and one edge inches and 16ths	\$0.60	\$0.04
1656	Triangular Boxwood Scale, 12 inch, divided $\frac{1}{8}$, $\frac{1}{4}$, $\frac{3}{8}$, $\frac{1}{2}$, $\frac{3}{4}$, 1, $1\frac{1}{2}$, 2, 3 and 4 inches to the foot, and one edge inches and 16ths	1.00	.16
1657	Triangular Boxwood Scale, 18 inch, divided $\frac{1}{8}$, $\frac{1}{4}$, $\frac{3}{8}$, $\frac{1}{2}$, $\frac{3}{4}$, 1, $1\frac{1}{2}$, 2, 3 and 4 inches to the foot, and one edge inches and 16ths	2.50	.20
1658	Triangular Boxwood Scale, 24 inch, divided $\frac{1}{8}$, $\frac{1}{4}$, $\frac{3}{8}$, $\frac{1}{2}$, $\frac{3}{4}$, 1, $1\frac{1}{2}$, 2, 3 and 4 inches to the foot, and one edge inches and 16ths	4.25	.25

TRIANGULAR BOXWOOD CHAIN SCALES

OF BEST QUALITY, FOR ENGINEERS

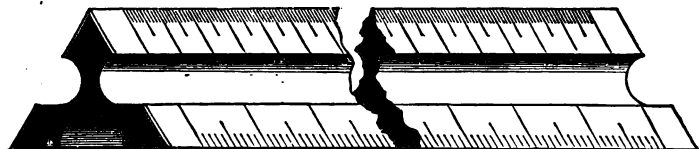

No. 1661

No.		PRICE	POST
1660	Triangular Boxwood Scale, 6 inch, divided 10, 20, 30, 40, 50 and 60 parts to the inch . . .	\$0.60	\$0.04
1661	Triangular Boxwood Scale, 12 inch, divided 10, 20, 30, 40, 50 and 60 parts to the inch . . .	1.00	.16
1662	Triangular Boxwood Scale, 18 inch, divided 10, 20, 30, 40, 50 and 60 parts to the inch . . .	2.50	.20
1663	Triangular Boxwood Scale, 24 inch, divided 10, 20, 30, 40, 50 and 60 parts to the inch . . .	4.25	.25
1665	Triangular Boxwood Scale, 12 inch, divided 20, 30, 40, 50, 60 and 80 parts to the inch . . .	1.00	.16
1668	Triangular Offset Scale, divided 2 inch, same as No. 166060	.02
1670	Triangular Boxwood Scale, 12 inch, divided 100, 200, 300, 400, 500 and 600 parts to the foot .	1.50	.16

TRIANGULAR BOXWOOD SCALES WITH WHITE EDGES

No.		PRICE	POST
1674	White Edge Scale, 6 inch, divided same as No. 1655 . . .	\$1.50	\$0.14
1675	White Edge Scale, 12 inch, divided same as No. 1656 . . .	2.50	.16
1678	White Edge Scale, 6 inch, divided same as No. 1660 . . .	1.50	.14
1679	White Edge Scale, 12 inch, divided same as No. 1660 . . .	2.50	.16
1682	White Edge Scale, 12 inch, divided same as No. 1665 . . .	2.50	.16
1684	White Edge Scale, 12 inch, divided same as No. 1670 . . .	2.50	.16

METALLIC TRIANGULAR SCALES

The Metallic Triangular Scales are made of brass tubing with the ends closed, nicked with a dull finish, and weigh about three and one half ounces.

The liability of the wood scales to crack, warp or twist, the chipping of their edges, and their variation from standard measurement are well known to all who have used them. These objections have been overcome in the metallic scale.

No.		PRICE	POST
1690	Metallic Triangular Scale, 12 inch, divided same as No. 1656	\$2.50	\$0.16
1692	Metallic Triangular Scale, 12 inch, divided same as No. 1660	2.50	.16
1694	Metallic Triangular Scale, 12 inch, divided same as No. 1665	2.50	.16
1698	Metal Guard for Triangular Scale (preventing errors)	.20	.02

METRIC SCALES AND RULES

No.		PRICE	POST
1700	Flat Boxwood Scale, 20 centimeters, divided to millimeters and $\frac{1}{2}$ millimeters	\$0.60	\$0.04
1701	Flat Boxwood Scale, 30 centimeters, divided to millimeters and $\frac{1}{2}$ millimeters	.75	.06
1702	Flat Boxwood Scale, 50 centimeters, divided to millimeters and $\frac{1}{2}$ millimeters	1.50	.18
1703	Flat White Edge Scale, 20 centimeters, divided to millimeters and $\frac{1}{2}$ millimeters	1.00	.14
1704	Flat White Edge Scale, 30 centimeters divided to millimeters and $\frac{1}{2}$ millimeters	1.25	.16
1706	Triangular Boxwood Scale, 20 centimeters, divided .01, .02, .03, .05, .025, .0125	.75	.05
1707	Triangular Boxwood Scale, 30 centimeters, divided to .01, .02, .03, .05, .025, .0125	1.00	.16
1710	Triangular Boxwood Scale, 30 centimeters, divided to millimeters and $\frac{1}{2}$ millimeters, also to 10ths, 12ths, and 16ths of inches, and 100ths of a foot	2.00	.16
1712	Triangular White Edge Scale, 30 centimeters, divided same as No. 1706	2.50	.16
1714	Triangular White Edge Scale, 30 centimeters, divided same as No. 1710	3.00	.16
1718	Flexible Wood Rule, four feet, eight fold, divided to millimeters and 16ths of inches, spring joints	.50	.05
1719	Flexible Wood Rule, same as No. 1718, and with white enamel finish	.60	.05

PAPER SCALES

No.		PRICE	Post
1722	Paper Scale, $\frac{1}{2}$ meter long, divided to millimeters	\$0.20	\$0.05
1723	Paper Scale, $\frac{1}{2}$ meter long, divided to millimeters and to 16ths of inches.	.30	.05
1724	Paper Scale, $1\frac{1}{4}$ inch wide, 12 inches long, graduations on one edge inches and 10ths, and the other feet and 100ths	.10	.02
1725	Paper Scale, same as No. 1724, edges 20 and 40 parts to the inch	.10	.02
1726	Paper Scale, same as No. 1724, edges 16 and 48 parts to the inch	.10	.02
	Paper Scales, printed on card paper, 18 inches long, for architects and engineers, as follows:		
1727	Series A contains 6 scales, one each divided to $\frac{1}{4}$, $\frac{1}{2}$, $\frac{3}{4}$, 1, $1\frac{1}{2}$ and 3 inches to the foot, each scale	.20	.04
1728	Series B contains 6 scales, one each divided $\frac{3}{2}$, $\frac{1}{8}$, $\frac{2}{8}$, $\frac{4}{8}$, $\frac{5}{8}$, and $\frac{3}{8}$ inches to the foot, each scale	.20	.04
1729	Series C contains 6 scales, one each divided to 10, 20, 30, 40, 50 and 60 parts to the inch, each scale	.20	.04

THACHERS CALCULATING INSTRUMENT

No.		PRICE
1730	Thachers Calculating Instrument, with cylinder 18 inches long. Performs a great variety of useful calculations with rapidity and accuracy. In mahogany box and with instruction book . . .	\$35.00
1731	Thachers Calculating Instrument, same as No. 1730, and with 3 inch reading glass sliding on brass bar, adjustable to any part of the instrument and for focus	45.00

CIRCULAR SLIDE RULES

FOR COMPUTING EARTHWORKS, EXCAVATIONS AND

No.	EMBANKMENTS	PRICE	Post
1732	Crockett Slide Rule. Applicable to any width of roadbed, any center height, any length, any side slope ratio, and to sections determined by any number of levels, without requiring the plotting of the end sections. $16\frac{1}{2}$ inches diameter, on heavy cardboard . . .	\$4.00	\$0.35
1734	Rudiger Slide Rule. Applicable to use with center height, and the surface slope measured in degrees. $16\frac{1}{2}$ inches diameter, on heavy cardboard	4.00	.35

Descriptive Circular of the Crockett and Rudiger Slide Rules mailed on application.

BOXWOOD AND IVORY POCKET RULES, ETC.



No. 1749

No.		PRIME.	POST.
1735	Boxwood Rule, one foot, four fold, 8ths and 16ths of inches	\$0.10	\$0.03
1736	Boxwood Rule, one foot, four fold, edge plates, 8ths and 16ths of inches15	.03
1737	Boxwood Rule, one foot, four fold, brass edges, bound, 8ths and 16ths of inches30	.04
1740	Boxwood Rule, two feet, four fold, 8ths and 16ths of inches15	.05
1741	Boxwood Rule, two feet, four fold, edge plates, 8ths, 10ths, 12ths and 16ths of inches, and drafting scales25	.05
1742	Boxwood Rule, two feet, four fold, brass edges, bound, 8ths, 10ths, 12ths and 16ths of inches, and drafting scales50	.06
1743	Boxwood Rule, two feet, four fold, edge plates, 8ths, 10ths, 12ths and 16ths of inches, and drafting scales, and inside beveled edges50	.05
1745	Boxwood Caliper Rule, one foot, four fold, edge plates, 8ths, 10ths, 12ths, and 16ths of inches50	.04
1747	Ivory Rule, one foot, four fold, edge plates, 8ths, 10ths, 12ths and 16ths of inches	1.75	.14
1748	Ivory Rule, one foot, four fold, edge plates, 8ths, 10ths, 12ths and 16ths of inches and 100ths of a foot	2.15	.14
1749	Ivory Rule, one foot, four fold, German silver edges, bound, divided like No. 1747	2.50	.15
1750	Ivory Caliper Rule, one foot, four fold, edge-plates, divided like No. 1747	2.70	.15
1751	Ivory Caliper Rule, one foot, four fold, German silver edges, bound, divided like No. 1747	3.30	.15
1753	Ivory Rule, two feet, four fold, edge plates, 8ths, 10ths, 12ths, and 16ths of inches, and 100ths of a foot	4.50	.17
1754	Ivory Rule, two feet, four fold, German silver edges, bound, 8ths, 10ths, 12ths, and 16ths of inches, and drafting scales	5.65	18

BOXWOOD AND IVORY POCKET RULES, ETC.

No.		Price	Post
1755A	Flexible Wood Rule, yellow finish, four feet, eight fold, divided to 16ths of an inch and 100ths of a foot, with spring joints	\$0.50	\$0.05
1755B	Flexible Wood Rule, same as No. 1755A, and with white enamel finish75	.05
1755C	Flexible Wood Rule, yellow finish, six feet, twelve fold, divided same as No. 1755A75	.08
1755D	Flexible Wood Rule, same as No. 1755C, and with white enamel finish	1.15	.08
1756A	Flexible Wood Rule, yellow finish, four feet, eight fold, divided alike on both sides to 16ths of inches, and with spring joints50	.05
1756B	Flexible Wood Rule, same as No. 1756A, and with white enamel finish60	.05
1758	Boxwood Shrink Rule, divided to 8ths, 10ths, 12ths and 16ths of inches. Either 24 ¹ / ₈ , 24 ¹ / ₄ , 24 ³ / ₈ , or 24 ¹ / ₂ = 24 inches. Each style	1.20	.18

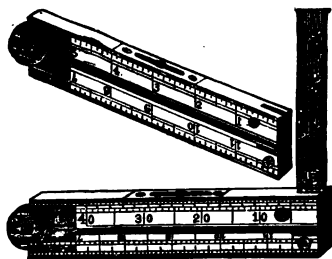

No. 1760

1760	Boxwood Combination Rule, one foot, two fold. It combines in itself a Carpenter's Rule, Spirit Level, Square, Plumb, Level, Indicator, Brace Scale, Drafting Scale of equal parts, T Square, Protractor, Right Angle Triangle, etc.	2.00	.17
------	---	------	-----

BOXWOOD AND IVORY POCKET RULES, ETC.

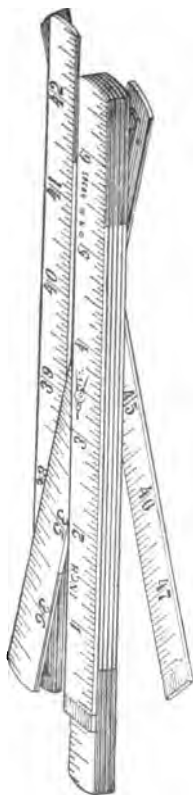

1755A to 1756B



1762



1764B

BOXWOOD SLIDE RULES

No.		PRICE	POST
1761	Mannheim Slide Rule, not adjustable, 10 inch, divided on white facings, with glass indicator and directions	\$3.00	\$0.15
1762	Faber's Slide Rule and Calculating Scale, 10½ inch, with glass indicator and directions	3.75	.20
1763	Students Slide Rule, for beginners, 10 inch, with indicator and directions	1.00	.15
1763A	Richardson's Direct Reading Slide Rule, 10 inch, celluloid scale, aluminum bound	2.50	.15
1764A	Engineers Adjustable Mannheim Slide Rule, 8 inch, divided on white facings, with glass indicator and directions	4.50	.15
1764B	Engineers Adjustable Mannheim Slide Rule, 10 inch, divided on white facings, with glass indicator and directions	4.50	.15
1764C	Engineers Adjustable Mannheim Slide Rule, 16 inch, divided on white facings, with glass indicator and directions	10.00	.30
1764D	Engineers Adjustable Mannheim Slide Rule, 20 inch, divided on white facings, with glass indicator and directions	12.50	.35
1764E	Magnifier, in metal frame, fitted for 8 and 10 inch Mannheim and Duplex Slide Rules	2.00	.14
1764F	Magnifier, in metal frame, fitted for 16 and 20 inch Mannheim Slide Rules	2.50	.15
1765	Duplex Slide Rule, 10 inch, divided on white facings, with glass indicator, Arithmetical slide and directions	5.00	.15
1767	Duplex Slide Rule, 10 inch, divided on white facings, with glass indicator and both Arithmetical and Trigonometrical slides and directions	6.50	.20
1768	Stadia Slide Rule, 20 inch, divided on white facings. This rule is designed to solve the equations generally used in stadia measurements	12.50	.35

For Treatises on Slide Rules, see page 527

STANDARD STEEL RULES

No.		PRICE	POST	No.		PRICE	POST
1770	3 inch	\$0.35	\$0.02	1775	18 inch	\$2.00	\$0.20
1772	6 inch65	.04	1776	24 inch	2.50	.25
1774	12 inch	1.25	.16	1777	36 inch	5.00	.50

These rules are divided on four edges in parts of inches as follows: 10, 20, 50, 100; 12, 24, 48; 16, 32, 64; 8.

STANDARD METRIC STEEL RULES

No.		PRICE	Post	No.		PRICE	Post
1780	$\frac{1}{10}$ meter	\$0.45	\$0.03	1783	$\frac{1}{2}$ meter	\$2.00	\$0.22
1781	$\frac{1}{5}$ meter	.85	.04	1784	1 meter	8.00	.55
1782	$\frac{3}{10}$ meter	1.25	.16				

These rules are divided to millimeters and $\frac{1}{2}$ millimeters.

TRIANGULAR STEEL RULES

No.		PRICE	Post	No.		PRICE	Post
1785	3 inch . . .	\$0.50	\$0.02	1787	6 inch . . .	\$1.00	\$0.14
1786	4 inch70	.03	1788	12 inch . . .	2.00	.16

These rules are divided on three edges in parts of inches as follows: 20, 50, 100; 12, 24, 48; 16, 32, 64.

SQUARE STEEL RULES

No.		PRICE	Post	No.		PRICE	Post
1790	3 inch . . .	\$0.45	\$0.02	1792	6 inch . . .	\$0.90	\$0.04
1791	4 inch60	.03				

These rules are divided on four edges in parts of inches as follows: 16, 32, 64, 100.

STEEL STRAIGHT EDGES. SQUARE EDGES

No.		NICKEL			No.		NICKEL		
		PLAIN	PLATED	POST			PLAIN	PLATED	POST
1800	15 inch	\$0.90	\$1.10	\$0.17	1804	36 inch	\$3.00	\$3.50	\$0.45
1801	18 inch	1.00	1.25	.20	1805	42 inch	4.00	4.50	.50
1802	24 inch	1.50	1.90	.25	1806	48 inch	6.00	6.60	.60
1803	30 inch	2.25	2.75	.30	1807	60 inch	8.00	8.75	

STEEL STRAIGHT EDGES, NICKEL PLATED

ONE EDGE BEVELED

No.		PRICE	Post	No.		PRICE	Post
1810	18 inch . . .	\$2.00	\$0.20	1813	36 inch . . .	\$5.00	\$0.45
1811	24 inch . . .	3.00	.25	1814	42 inch . . .	6.50	.50
1812	30 inch . . .	4.00	.30	1815	48 inch . . .	8.00	.60

MAHOGANY STRAIGHT EDGES, AMBER LINED
SQUARE EDGES



No. 1820

No.		PRICE	Post	No.		PRICE	Post
1820	18 inch . .	\$0.90	\$0.06	1823	36 inch . .	\$1.90	\$0.25
1821	24 inch . .	1.10	.18	1824	42 inch . .	2.50	.30
1822	30 inch . .	1.25	.20	1825	48 inch . .	3.00	.35

MAHOGANY STRAIGHT EDGES, EBONY LINED
SQUARE EDGES



No. 1830

No.		PRICE	Post	No.		PRICE	Post
1830	24 inch . .	\$0.50	\$0.08	1833	42 inch . .	\$1.00	\$0.30
1831	30 inch . .	.60	.10	1834	48 inch . .	1.35	.35
1832	36 inch . .	.80	.15	1835	60 inch . .	2.00	

HARDWOOD STRAIGHT EDGES

ONE EDGE BEVELED



No. 1850

No.		PRICE	Post	No.		PRICE	Post
1850	18 inch . .	\$0.20	\$0.06	1854	42 inch . .	\$0.50	\$0.20
1851	24 inch . .	.25	.08	1855	48 inch . .	.65	.25
1852	30 inch . .	.30	.10	1856	60 inch . .	1.00	
1853	36 inch . .	.40	.15	1857	72 inch . .	1.25	

T SQUARES

MAHOGANY T SQUARES, WITH AMBER EDGES AND FIXED HEAD

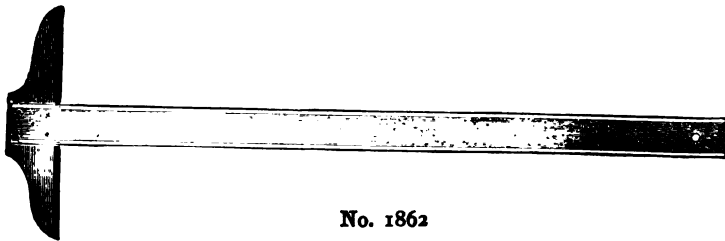

No. 1862

No.	PRICE	POST	No.	PRICE
1860 18 inch . .	\$1.10	\$0.25	1863 36 inch . .	\$2.15
1861 24 inch . .	1.50	.35	1864 42 inch . .	2.50
1862 30 inch . .	1.85	.45	1865 48 inch . .	3.00

MAHOGANY T SQUARES, WITH AMBER EDGES AND SHIFTING HEAD

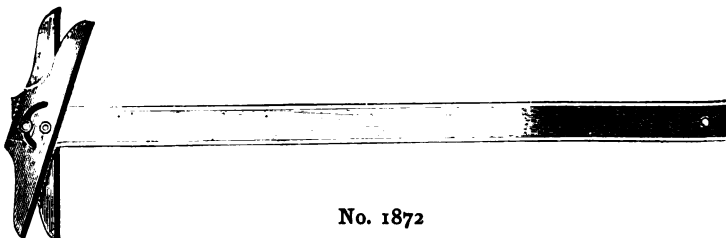

No. 1872

No.	PRICE	POST	No.	PRICE
1870 18 inch . .	\$1.90	\$0.30	1873 36 inch . .	\$3.20
1871 24 inch . .	2.45	.40	1874 42 inch . .	3.60
1872 30 inch . .	2.80	.50	1875 48 inch . .	4.20

STEEL BLADE T SQUARES, NICKEL PLATED, WITH FIXED JAPANED IRON HEAD

No.	PRICE	POST	No.	PRICE	POST
1896 18 inch . .	\$3.00	\$0.35	1898 30 inch . .	\$4.50	\$0.45
1897 24 inch . .	3.50	.40	1899 36 inch . .	5.50	

**STEEL BLADE T SQUARES, NICKEL PLATED,
WITH SHIFTING JAPANED IRON HEAD**

No.		PRICE	Post	No.		PRICE	Post
1902	18 inch . .	\$4.25	\$0.45	1904	30 inch . .	\$5.75	\$0.55
1903	24 inch . .	5.00	.50	1905	36 inch . .	6.75	

HARDWOOD T SQUARES, FIXED HEAD

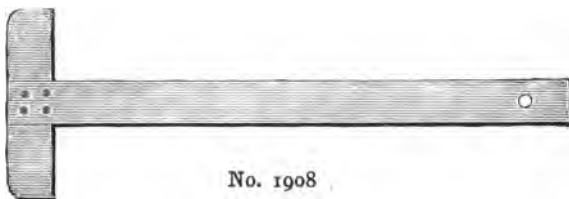

No. 1908

No.		PRICE	Post	No.		PRICE	Post
1908	15 inch . .	\$0.25	\$0.15	1911	30 inch . .	\$0.45	\$0.45
1909	20 inch . .	.30	.25	1912	40 inch . .	.65	
1910	25 inch . .	.35	.35	1913	50 inch . .	.90	

HARDWOOD T SQUARES, SHIFTING HEAD

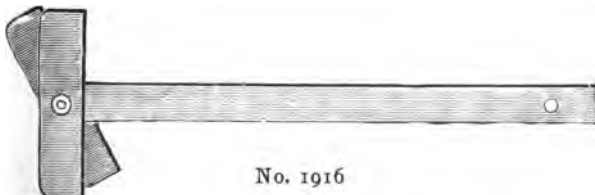

No. 1916

No.		PRICE	Post	No.		PRICE	Post
1916	15 inch . .	\$0.60	\$0.20	1919	30 inch . .	\$0.80	\$0.50
1917	20 inch . .	.65	.30	1920	40 inch . .	1.00	
1918	25 inch . .	.70	.40	1921	50 inch . .	1.35	

**MAHOGANY T SQUARES, WITH EBONY EDGES
AND FIXED HEAD**

No.		PRICE	Post	No.		PRICE	Post
1922	24 inch . .	\$1.00	\$0.35	1924	36 inch . .	\$1.40	
1923	30 inch . .	1.20	.45	1925	42 inch . .	1.60	

MAHOGANY T SQUARES, WITH EBONY EDGES AND SHIFTING HEAD

No.		PRICE	POST	No.		PRICE
1926	24 inch . .	\$1.75	\$0.40	1928	36 inch . .	\$2.25
1927	30 inch . .	2.00	.50	1929	42 inch . .	2.50

T SQUARES, WITH DEANE'S PATENT SWIVEL AND ADJUSTMENT

MAHOGANY BLADES WITH AMBER EDGES

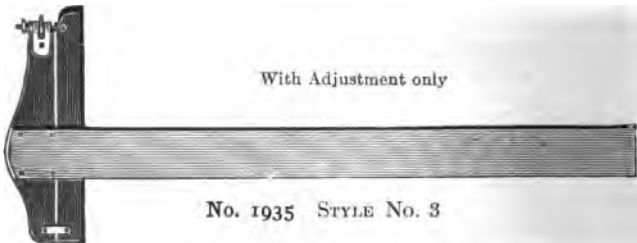
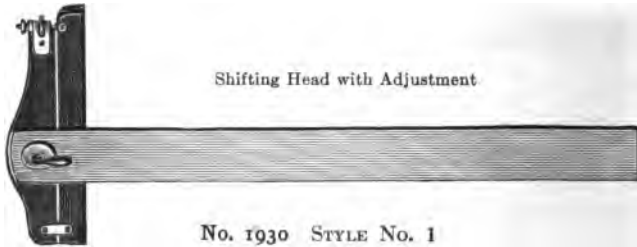

No.		PRICE	POST
1930	24 inch, Style No. 1	\$3.25	\$0.40
1931	30 inch, Style No. 1	3.65	.45
1932	36 inch, Style No. 1	4.25	
1935	24 inch, Style No. 3	2.75	.38
1936	30 inch, Style No. 3	3.25	.43
1937	36 inch, Style No. 3	3.75	

DRAWING TABLES

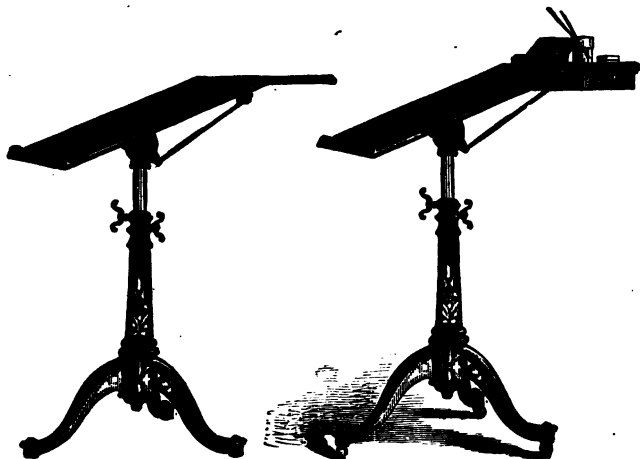

No. 1946

No. 1947

No.		Price
1945	Drawing Table, hardwood top, 24 x 22 inches	\$8.75
1946	Drawing Table, hardwood top, 24 x 22 inches, and with instrument shelf, 24 x 7 inches	10.00
1947	Drawing Table, hardwood top, 26 x 22 inches, instrument shelf, 26 x 7 inches, two instrument drawers, ornamented stand	13.25
1949	Drawing Table, hardwood top, 26 x 22 inches, with instrument shelf and two drawers, and with folding arm and plain shelf, ornamented stand	17.00

These Tables are adjustable for horizontal and angular motion and for heights about 30 to 44 inches. The shelves and drawers remain level when the top is inclined. They are mounted on an iron stand with casters.

THE WORCESTER DRAWING TABLE



No. 1950

No.		PRICE
1950	Drawing Table, with white pine drawing board, 42 x 31 inches, and substantial iron stand, adjustable . .	\$25.00
1951	Drawing Table, with white pine drawing board, 55 x 33 inches, and substantial iron stand, adjustable . .	26.50
1952	Drawing Table, with white pine drawing board, 60 x 36 inches, with substantial iron stand, adjustable . .	28.00

These tables are adjustable for horizontal, angular, and vertical movements.

DRAWING BOARDS AND TRESTLES

No.		PRICE
1960	Drawing Board, pinewood, 14 x 10 inches	\$0.60
1962	Drawing Board, pinewood, 20 x 15 inches, tongue and groove ends75
1964	Drawing Board, pinewood, 28 x 20 inches, tongue and groove ends	1.50
1966	Drawing Board, pinewood, 40 x 28 inches, tongue and groove ends	2.50

DRAWING BOARDS AND TRESTLES

No.		PRICE
1967	Drawing Board, pinewood, 55 x 33 inches, dovetailed cleats on under side	\$8.00
1970	Drawing Board, with mahogany frame, and removable pinewood center, 18 x 15 inches	3.00
1972	Drawing Board, with mahogany frame, and removable pinewood center, 25 x 17 inches	4.00
	Drawing Boards and Trestles of any size made to order.	
1975	Pinewood Horses, 37 inches high, 35 inches long, with removable sloping ledges. Per pair	5.00
1977	Folding Trestle, hardwood, 37 inches high, 33 inches long, 26 inches wide	10.00



No. 1978

1978	Folding Trestle, hardwood, 37 inches high, combined with adjustable Drawing Board of pinewood, 42 x 31 inches, and hinged to the Trestle. All folding compactly	14.00
1979	Folding Trestle and Drawing Board, same as No. 1978, but with the Drawing Board 55 x 33 inches	16.50

TRIANGLES

OPEN STEEL TRIANGLES. NICKEL PLATED

		30° x 60° x 90°				45° x 45° x 90°	
No.		PRICE	POST	No.		PRICE	POST
1982	6 inch . . .	\$3.20	\$0.15	1986	10½ inch . .	\$4.25	\$0.25
1984	8 inch . . .	3.85	.20	1989	15 inch . .	6.50	.40
1992	6½ inch . . .	3.50	.18	1996	10 inch . .	5.50	.35
1994	8 inch . . .	4.25	.25	1998	12 inch . .	6.50	.45

OPEN GERMAN SILVER TRIANGLES

		30° x 60° x 90°				45° x 45° x 90°	
No.		PRICE	POST	No.		PRICE	POST
2002	5½ inch . . .	\$2.50	\$0.15	2006	10 inch . .	\$4.00	\$0.25
2004	8 inch . . .	3.00	.20	2008	12 inch . .	5.00	.30
2012	6 inch . . .	2.75	.18	2016	10 inch . .	5.00	.35
2014	8 inch . . .	4.00	.25	2018	12 inch . .	6.50	.45

TRANSPARENT AMBER TRIANGLES



Nos. 2022 to 2032
30° x 60° x 90°



Nos. 2036 to 2046
45° x 45° x 90°

TRANSPARENT AMBER TRIANGLES

30° x 60° x 90°					
No.		PRICE	POST	No.	PRICE POST
2022	4 inch . . .	\$0.25	\$0.03	2028	10 inch . . \$0.75 \$0.08
2024	6 inch40	.04	2030	12 inch . . 1.00 .18
2026	8 inch55	.06	2032	14 inch . . 1.65 .20
45° x 45° x 90°					
2036	4 inch35	.04	2042	8 inch . . .75 .08
2038	6 inch55	.05	2044	10 inch . . 1.10 .18
2040	7 inch65	.07	2046	12 inch . . 1.65 .2

HARD RUBBER TRIANGLES



No. 2052
30° x 60° x 90°



No. 2074
45° x 45° x 90°

30° x 60° x 90°					
No.		PRICE	POST	No.	PRICE POST
2052	4 inch . . .	\$0.20	\$0.03	2058	10 inch . . \$0.65 \$0.08
2054	6 inch30	.04	2060	12 inch . . .90 .10
2055	7 inch35	.05	2062	14 inch . . 1.25 .20
2056	8 inch45	.06	2064	16 inch . . 1.50 .25
45° x 45° x 90°					
2074	4 inch25	.04	2078	8 inch . . .65 .08
2075	5 inch35	.05	2080	10 inch . . .95 .10
2076	6 inch45	.05	2082	12 inch . . 1.30 .20
2077	7 inch50	.07	2084	14 inch . . 1.85 .25

Other sizes of Amber or Rubber Triangles to order.

HARDWOOD TRIANGLES, OPEN CENTER, FRAMED



No. 2092
30° x 60° x 90°

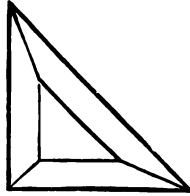

No. 2108
45° x 45° x 90°

30° x 60° x 90°				45° x 45° x 90°			
No.		PRICE	POST	No.		PRICE	POST
2092	6 inch . .	\$0.16	\$0.04	2098	12 inch . .	\$0.30	\$0.10
2094	8 inch . .	.20	.06	2100	14 inch . .	.38	.12
2096	10 inch . .	.25	.08	2102	15 inch . .	.45	.18
2107	5 inch . .	.16	.05	2110	8 inch . .	.24	.08
2108	6 inch . .	.18	.05	2112	10 inch . .	.30	.10
2109	7 inch . .	.21	.08	2114	12 inch . .	.35	.12

HARDWOOD TRIANGLES, PLAIN

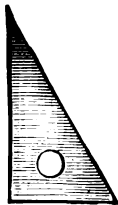

No. 2120
30° x 60° x 90°

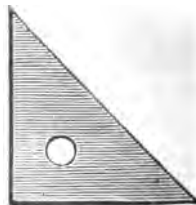

No. 2130
45° x 45° x 90°

30° x 60° x 90°				45° x 45° x 90°			
No.		PRICE	POST	No.		PRICE	POST
2120	4 inch . . .	\$0.05	\$0.03	2124	8 inch . . .	\$0.12	\$0.06
2122	6 inch08	.04	2126	10 inch15	.08
2130	4 inch06	.04	2132	6 inch10	.05
2131	5 inch08	.05	2134	8 inch13	.08

HARD RUBBER LETTERING TRIANGLES

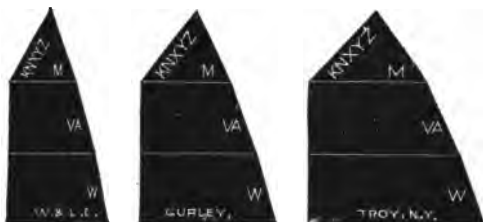

No. 2140

No.		Price	Post
2140	Lettering Triangles for Block Letters, 3½ inch, three in a set. Per set	\$1.35	\$0.15



No. 2145

2145	Lettering Triangles for Shaded Letters, 3½ inch, three in a set. Per set	1.20	.15
------	---	------	-----



No. 2147

2146	Hard Rubber Lettering Templets, three in a set. Per set	1.50	.17
2147	Transparent Amber Lettering Templets, three in a set. Per set	2.00	.17

SECTION LINERS

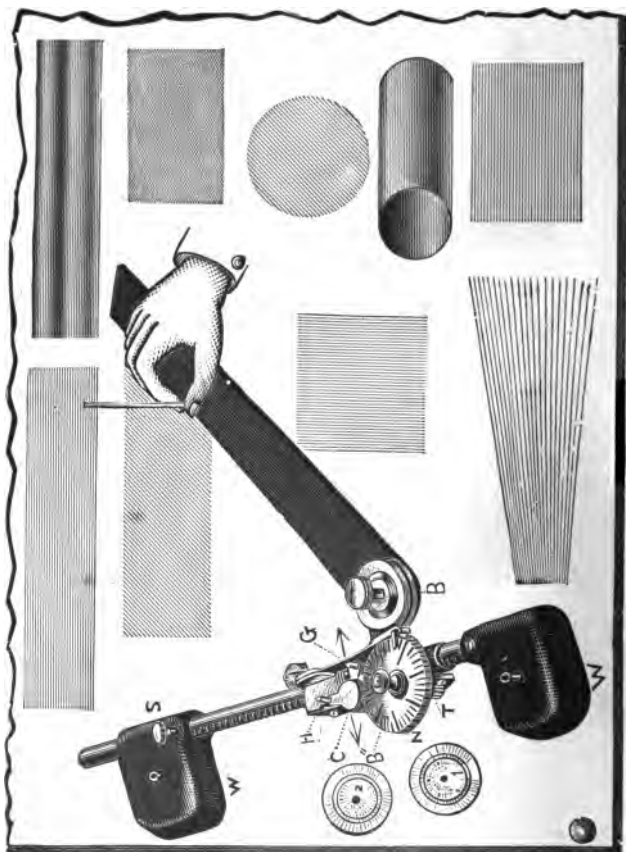

No. 2155

This Section Liner is positive in all its motions, being operated by a rack and pinion movement. The rack rod passes through two heavy weights and is held securely by clamp screws. Two needle pointed pins aid to hold the weights in place when necessary. Lines can be drawn at any angle, in any direction, and on any part of the board.

SECTION LINERS

No.		PRICE
2155	Section Liner with 12 inch rack and 12 inch blade . . .	\$6.50
2156	Section Liner with 14 inch rack and 14 inch blade . . .	7.50

Two plain notched wheels are furnished with each instrument for producing 64 and 100 parts to the inch. Extra wheels for either 10, 12, 20, 24, 40, 48 or 50 parts to the inch will be furnished for \$1.50 each. These notched wheels when graduated on the face for ruling and measuring combined, will cost \$2.25 each.

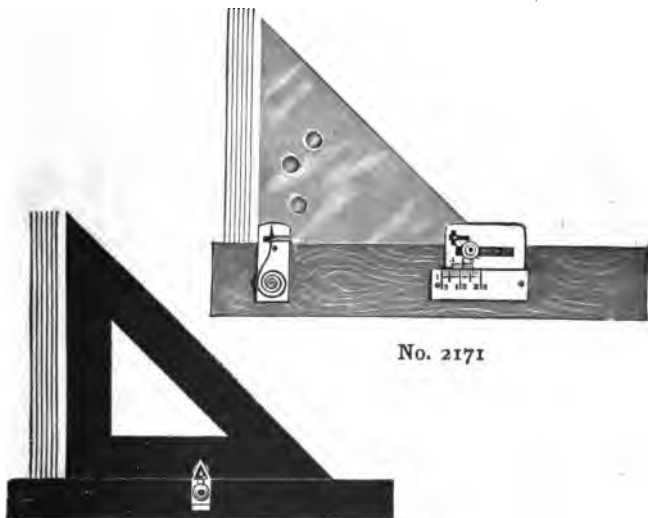

No. 2171

No. 2168

No.		PRICE	POST
2168	Marion's Section Liner with 7 inch triangle and 10 inch ruler	\$2.00	\$0.20
2170	Standard Section Liner. Especially adapted for school use and mechanical sectional drawing	1.50	.20
2171	Casey's Section Liner with amber triangle boxwood straight edge and German silver mountings. By two scales and verniers on the plates, distances are measured to 100th inch or 10th millimeter	3.50	.20

**IRREGULAR CURVES OF HARD RUBBER,
AMBER AND WOOD**

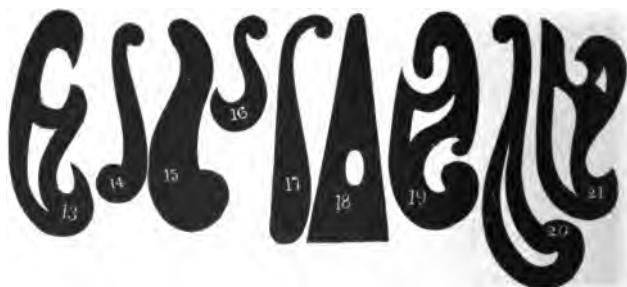

Nos. 2180, 2182 and 2184

**IRREGULAR CURVES OF HARD RUBBER,
AMBER AND WOOD**

No.		PRICE	POST
2180	Hard Rubber Curves, Nos. 1, 2, 5, 14, 15, 16, 17, 18, 22, 23, 25 and 26. Each	\$0.35	\$0.03
	Hard Rubber Curves, Nos. 13, 19, 20 and 21. Each	.45	.03
	Hard Rubber Curves, Nos. 3, 4 and 24. Each	.50	.05
	Hard Rubber Curve, No. 27	.75	.08
	Hard Rubber Curve, No. 28	2.00	.18
	Hard Rubber Curve, Logarithmic Spiral, No. 29	1.25	.15
2182	Transparent Amber Curves, Nos. 1, 2, 5, 16, 22, 25 and 26. Each	.45	.03
	Transparent Amber Curves, Nos. 3, 4, 13, 19 and 20. Each	.60	.05
	Transparent Amber Curve, No. 24	.75	.05
	Transparent Amber Curve, No. 27	.90	.08
2184	Wood Curves, Nos. 1, 5, 21, 25 and 26. Each	.25	.03
	Wood Curves, Nos. 3, 4, 13, 19, 20 and 24. Each	.30	.05
	Wood Curve, No. 27	.35	.08

ADJUSTABLE CURVE RULER



No. 2186

No.		PRICE	POST
2186	Adjustable Curve Ruler, 14½ inches long	\$2.25	\$0.16
2187	Adjustable Curve Ruler, 30 inches long	3.30	.35

These rulers can be instantly adjusted and retained to any form of curve.

This tool is recommended by architects and draftsmen, and meets a long felt want. It is well made, neatly finished and nickel plated.

ELLIPSES, HYPERBOLAS AND PARABOLAS

No.		PRICE	POST
2190	Hard Rubber Ellipses, 6 in a set, 2 to 4½ inch. Per set	\$1.50	\$0.14
2191	Hard Rubber Ellipses, 10 in a set, 1½ to 6 inch. Per set	2.50	.16
2194	Wood Ellipses, 6 in a set, 2 to 4½ inch. Per set	1.25	.14
2195	Wood Ellipses, 10 in a set, 1½ to 6 inch. Per set	2.00	.16
2200	Wood Hyperbolas, 8 in a set, 2 to 5½ inch. Per set	1.50	.15
2204	Wood Parabolas, 8 in a set, 1¼ to 5⅝ inch. Per set	1.50	.15

RAILROAD CURVES

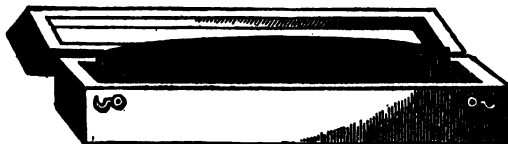

No. 2210

No.		PRICE	POST
	Set of 10 Curves, cut to a scale of inches, from 12 to 120 inches radius, varying every 12 inches.		
2210	Rubber Curves, in wood box	\$6.50	\$0.30
2211	Wood Curves, in wood box	3.50	.30
	Set of 24 Curves, cut to a scale of inches, from $1\frac{1}{2}$ to 24 inches radius, varying every $\frac{1}{2}$ inch up to 10 inches, and then every 2 inches up to 24 inches		
2214	Rubber Curves, in wood box	15.00	.40
2215	Wood Curves, in wood box	9.00	.40
	Set of 10 Curves, cut to a scale of 40 feet to the inch, from 1° to 10° , varying every degree.		
2218	Rubber Curves, in wood box	6.50	.30
2219	Wood Curves, in wood box	3.50	.30
	Set of 20 Curves, cut to a scale of 40 feet to the inch, from 1° to 20° , varying every degree.		
2222	Rubber Curves, in wood box	12.50	.35
2223	Wood Curves, in wood box	7.50	.35
	Set of 12 Curves, cut to a scale of 100 feet to the inch, from 1° to 12° , varying every degree		
2226	Rubber Curves, in wood box	8.00	.30
2227	Wood Curves, in wood box	5.00	.30
	Set of 20 Curves, cut to a scale of 400 feet to the inch, from $30'$ to 10° , varying every 30 minutes.		
2238	Rubber Curves, in wood box	12.50	.35
2239	Wood Curves, in wood box	7.50	.35

PARALLEL RULES



No. 2250

EBONY PARALLEL RULES

No.		PRICE	Post	No.		PRICE	Post
2250	6 inch . .	\$0.35	\$0.04	2253	15 inch . .	\$1.00	\$0.20
2251	9 inch . .	.55	.06	2254	18 inch . .	1.25	.22
2252	12 inch . .	.75	.08	2255	24 inch . .	1.75	.25

HARD RUBBER PARALLEL RULES

No.		PRICE	Post	No.		PRICE	Post
2260	6 inch . . .	\$0.75	\$0.04	2262	12 inch . .	\$1.25	\$0.18
2261	9 inch . . .	1.00	.06	2263	15 inch . .	1.50	.20

EBONY PARALLEL RULES, ON ROLLERS

No.		PRICE	Post	No.		PRICE	Post
2270	9 inch . .	\$2.75	\$0.20	2272	15 inch . .	\$4.00	\$0.30
2271	12 inch . .	3.25	.25	2273	18 inch . .	5.00	.35

HARD RUBBER PARALLEL RULES, ON ROLLERS

No.		PRICE	Post	No.		PRICE	Post
2275	9 inch . .	\$3.50	\$0.20	2277	15 inch . .	\$5.00	\$0.30
2276	12 inch . .	4.25	.25	2278	18 inch . .	6.00	.35

EBONY PARALLEL RULES, ON ROLLERS

WITH WHITE EDGES, DIVIDED $\frac{1}{8}$, $\frac{1}{4}$, $\frac{1}{2}$, 1 INCH TO THE FOOT

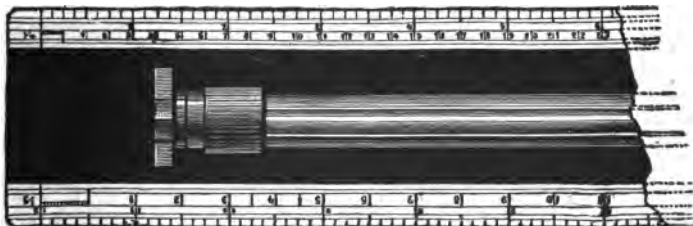

No. 2280

No.		PRICE	Post	No.		PRICE	Post
2280	12 inch . .	\$5.00	\$0.25	2282	18 inch . .	\$7.50	\$0.35
2281	15 inch . .	6.50	.30				

BRASS PARALLEL RULES, ON ROLLERS

No.		Price	Post	No.		Price	Post
2285	9 inch . .	\$7.25	\$0.50	2287	15 inch . .	\$10.00	\$0.50
2286	12 inch . .	8.50	.40	2288	18 inch . .	12.00	

GERMAN SILVER PARALLEL RULES,
ON ROLLERS

No.		Price	Post	No.		Price	Post
2292	9 inch . .	\$8.50	\$0.30	2294	15 inch . .	\$12.00	\$0.50
2293	12 inch . .	10.00	.40	2295	18 inch . .	15.00	

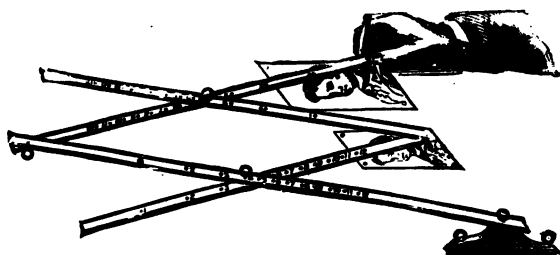
PANTOGRAPHS FOR ENLARGING OR
REDUCING DRAWINGS

No. 2300

No.		Price	Post
2300	Pantograph, hardwood, brass mountings, with arms 21 inches long	\$1.50	\$0.30
2302	Pantograph, hardwood, nickel plated mountings, with arms 21 inches long	2.50	.30
2304	Pantograph, hardwood, brass mountings, with arms 22½ inches long, adapted for 15 ratios	3.50	
2306	Pantograph, hardwood, brass mountings, with arms 41 inches long and joints formed by bolts and thumbnuts. Adapted for 34 ratios	5.00	

DRAWING PAPER

ARCHITECTS PAPER FOR PLANS

WHITE, STRONG, SMOOTH SURFACE

No.		PRICE	POST
2350	Medium, 23 x 18 inches, per sheet, 6 cents; per quire	\$1.25	\$0.48
2352	Super Royal, 28 x 20 inches, per sheet, 8 cents; per quire	1.75	.60
2355	30 inches wide, per roll of 10 yards	1.25	.40
2356	36 inches wide, per roll of 10 yards	1.50	.50
2357	42 inches wide, per roll of 10 yards	1.75	.60

WHATMANS DRAWING PAPER

SELECTED, BEST QUALITY, GRAINED SURFACE

No.		PRICE	POST
2360	Demy, 20 x 15 inches, per sheet, 5 cents; per quire	\$0.95	\$0.28
2361	Medium, 22 x 17 inches, per sheet, 7 cents; per quire	1.40	.40
2362	Royal, 24 x 19 inches, per sheet, 9 cents; per quire	1.80	.50
2363	Super Royal, 27 x 19 inches, per sheet, 10 cents; per quire	2.10	.55
2365	Imperial, 30 x 22 inches, per sheet, 17 cents; per quire	3.00	.68
2368	Double Elephant, 40 x 26 inches, per sheet, 25 cents; per quire	5.75	1.38

WHATMANS DRAWING PAPER

MOUNTED ON MUSLIN

No.		PRICE	POST
2370	Royal, 24 x 19 inches, per sheet	\$0.30	\$0.10
2372	Imperial, 30 x 22 inches, per sheet	.50	.13
2374	Double Elephant, 40 x 27 inches, per sheet	.90	.18

BRISTOL BOARD DRAWING PAPER

No.		PRICE	POST
2380	Patent Office, Bristol Board, 15 x 10 inches, per sheet, 6 cents; per dozen	\$0.60	\$0.20
2381	Bristol Board, 20 x 15 inches, per sheet, 12 cents; per dozen	1.20	.50
2385	Patent Office Bristol Board, printed with border, etc., 15 x 10 inches, per sheet, 8 cents; per dozen	.75	.20

DETAIL DRAWING PAPER, CREAM BUFF TINT
SUPERIOR QUALITY, IN ROLLS OF 35 TO 40 POUNDS

No.		PRICE	Post
2389	30 inches wide, per pound, 29 cents; per yard .	\$0.13	\$0.10
2390	36 inches wide, per pound, 29 cents; per yard .	.15	.12
2391	42 inches wide, per pound, 29 cents; per yard .	.20	.20

BLEACHED MANILLA PAPER

FOR WORKSHOP DRAWINGS, BEST-AMERICAN MAKE, IN ROLLS
OF ABOUT 50 POUNDS

No.		PRICE	Post
2395	36 inches wide, medium, per pound, 12 cents; per yard	\$0.08	\$0.12
2396	42 inches wide, medium, per pound, 12 cents; per yard10	.14
2397	48 inches wide, medium, per pound, 12 cents; per yard12	
2398	54 inches wide, medium, per pound, 12 cents; per yard15	

AMERICAN WHITE ROLL DRAWING PAPER

VERY STRONG AND OF EXCELLENT QUALITY, IN ROLLS
OF ABOUT 40 POUNDS

No.		PRICE	Post
2410	36 inches wide, smooth surface, per pound, 45 cents; per yard	\$0.25	\$0.12
2411	42 inches wide, smooth surface, per pound, 45 cents; per yard30	.14
2413	62 inches wide, smooth surface, per pound, 45 cents; per yard50	
2414	72 inches wide, smooth surface, per pound, 50 cents; per yard70	

EXCELSIOR WHITE ROLL DRAWING PAPER

IN ROLLS OF ABOUT 40 POUNDS

No.		PRICE	Post
2420	36 inches wide, grained surface, per pound, 36 cents; per yard	\$0.20	\$0.12
2421	42 inches wide, grained surface, per pound, 36 cents; per yard24	.14

Small quantities of paper must be put on a wooden roller when sent by mail. Several yards can be put on a single roller, with but little extra for postage. The pound price for papers Nos. 2389 to 2434 applies only to full rolls.

BEST EGGSHELL DRAWING PAPER

IN ROLLS OF ABOUT 40 POUNDS

No.		PRICE	POST
2430	36 inches wide, pebbled surface, per pound, 50 cents; per yard	\$0.33	\$0.13
2431	42 inches wide, pebbled surface, per pound, 50 cents; per yard38	.15
2434	58 inches wide, pebbled surface, per pound, 50 cents; per yard50	
2435	58 inches wide, thick, pebbled surface, per pound, 50 cents; per yard65	

MOUNTED DRAWING PAPER

WHITE, MOUNTED ON MUSLIN, IN ROLLS OF 10 YARDS

No.		PRICE	POST
2450	American, 36 inches wide, smooth surface, per roll, \$6.65; per yard	\$0.80	\$0.25
2451	American, 42 inches wide, smooth surface, per roll, \$8.45; per yard	1.00	.30
2453	American, 62 inches wide, smooth surface, per roll, \$13.60; per yard	1.60	
2454	American, 72 inches wide, smooth surface, per roll, \$18.00; per yard	2.25	
2460	Eggshell, 36 inches wide, pebbled surface, per roll, \$7.50; per yard90	.25
2461	Eggshell, 42 inches wide, pebbled surface, per roll, \$9.30; per yard	1.10	.30
2463	Eggshell, 58 inches wide, medium thick, pebbled surface, per roll, \$12.50; per yard	1.45	
2464	Eggshell, 58 inches wide, thick, pebbled surface, per roll, \$13.75; per yard	1.60	
2467	Paper Cloth, 38 inches wide, smooth surface, per yard42	.20

Large pieces, for City, County, or State Maps, mounted to order.

DRAWING PARCHMENT

No.		PRICE	POST
2468	38 inches wide, medium, per roll of 20 yards, \$3.00; per yard	\$0.20	\$0.12

TRACING PAPER

No.		PRICE	POST
2470	Pellucid, common, 21 inches wide, per yard, 5 cents; per roll of 20 yards	\$0.75	\$0.18
2471	Pellucid, common, 42 inches wide, per yard, 10 cents; per roll of 20 yards	1.50	.40

TRACING PAPER

No.		PRICE	Post
2472	Vegetable, 30 inches wide, per yard, 10 cents; per roll of 20 yards	\$1.50	\$0.40
2474	Bank Note, 36 inches wide, per yard, 10 cents; per roll of 20 yards	1.62	.40
2475	Bank Note, 42 inches wide, per yard, 13 cents; per roll of 20 yards	2.00	.45
2476	Parchment, 39 inches wide, per yard, 22 cents; per roll of 20 yards	3.50	.60
2477A	Vellum, 36 inches wide, per yard, 25 cents; per roll of 20 yards	4.00	.55
2477B	Vellum, 42 inches wide, per yard, 32 cents; per roll of 20 yards	5.00	.65
2478	Bond, 42 inches wide, per yard, 15 cents; per roll of 20 yards	2.00	.45
2479	Manilla, common, 48 inches wide, per yard, 7 cents; per roll of 20 yards	1.00	.50
2480	Vegetable, 25 x 19 inches, per sheet, 10 cents; per quire	2.00	.20
2482	Flaxine, 31 x 21 inches, per sheet, 12 cents; per quire	2.50	.25
2484	Bond, 21 x 16 inches, per sheet, 6 cents; per quire	1.00	.20
2486	Bond, 30 x 19 inches, per sheet, 8 cents; per quire	1.40	.30
2493	Pounce Powder, in tin shaker, for Tracing paper or Tracing cloth, each	.15	.07

IMPERIAL TRACING CLOTH

IN ROLLS OF 24 YARDS, FACE GLAZED AND BACK DULL

No.		PRICE	Post
2495	30 inches wide, per yard, 40 cents; per roll . .	\$8.10	\$0.70
2496	36 inches wide, per yard, 45 cents; per roll . .	9.00	1.10
2497	42 inches wide, per yard, 60 cents; per roll . .	12.10	1.25
2498	48 inches wide, per yard, 80 cents; per roll . .	16.00	
2499	54 inches wide, per yard, 85 cents; per roll . .	17.00	

PREPARED BLUE PRINT PAPER

BEST QUALITY; READY FOR IMMEDIATE USE

No.		PRICE	Post
2506	Sensitized Paper, 24 inches wide, per yard, 15 cents; per roll of 10 yards	\$1.20	\$0.40
2508	Sensitized Paper, 30 inches wide, per yard, 18 cents; per roll of 10 yards	1.50	.50
2510	Sensitized Paper, 36 inches wide, per yard, 20 cents; per roll of 10 yards	1.65	.60

PREPARED BLUE PRINT PAPER

No.		PRICE	Post
2512	Sensitized Paper, 42 inches wide, per yard, 22 cents; per roll of 10 yards	\$1.80	\$0.70
2515W	White Ink, for altering Blue prints, per bottle20	.06
2515R	Red Ink, for altering Blue prints, per bottle20	.06
2515Y	Yellow Ink, for altering Blue prints, per bottle20	.06

BLUE PRINT PAPER, NOT PREPARED

No.		PRICE	Post
2520	24 inches wide, per roll of 10 yards	\$0.80	\$0.35
2522	30 inches wide, per roll of 10 yards	1.00	.45
2524	36 inches wide, per roll of 10 yards	1.15	.55

THE BLUE PROCESS OF COPYING TRACINGS

Special attention is directed to this easy process of copying tracings, and its great value to all Engineers, Architects and Mechanical Draftsmen is fully recognized.

If not convenient to procure a Print Frame, blue prints can be made readily by following these directions:—

1 Provide a flat board as large as the tracing which is to be copied.
 2 Lay on this board a cushion of blanket or felt about $\frac{1}{4}$ inch thick, to give a slightly yielding backing for the paper.

3 Lay on the blanket the prepared paper with the sensitive side uppermost.

4 Lay on this paper the tracing, making it as smooth as possible, so as to insure perfect contact with the paper.

5 Lay on the tracing a plate of clear glass, which should be heavy enough to press the tracing close down upon the paper. Ordinary plate glass, one quarter of an inch in thickness, is sufficient.

6 Expose the whole to a clear sunlight by pushing it out on a shelf from a window, or in any other convenient way, from four to six minutes (in winter, six to ten minutes). If a clear sky only can be had, the exposure must be continued from twenty to thirty minutes; and under a cloudy sky from sixty to ninety minutes may be needed, the shade depending on the time.

7 Remove the prepared paper and wash it freely for one or two minutes in clear water, and hang it by one corner to dry.

Too light a blue means under exposure, and too dark a blue is over exposure.

PRINT FRAMES AND BATH TRAYS

PRINT FRAMES

MADE OF HARDWOOD, WITH BRASS MOUNTINGS,
CUSHION AND PLATE GLASS

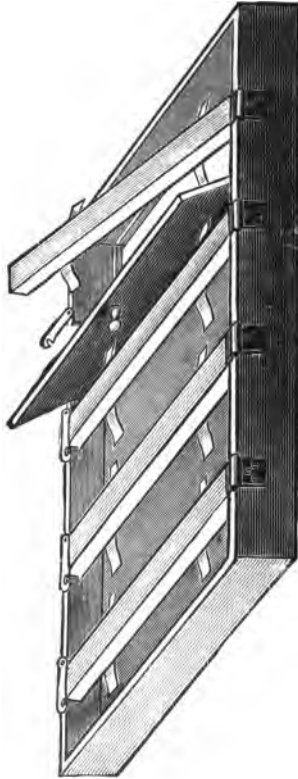

No. 2534

No.		PRICE
2534	Print Frame, complete with Plate Glass and Cushion, 24 x 20 inches, clear exposure	\$9.00
2536	Print Frame, complete with Plate Glass and Cushion, 30 x 24 inches, clear exposure	13.50
2538	Print Frame, complete with Plate Glass and Cushion, 42 x 30 inches, clear exposure	22.50

ZINC BATH TRAYS, WITH WOODEN FRAMES

FOR WASHING BLUE PRINTS IN WATER BATH

No.		PRICE	Post
2540	Zinc Bath Tray, for washing copies, 24 x 20 inches . .	\$3.75	\$3.75
2542	Zinc Bath Tray, for washing copies, 30 x 24 inches . .	4.50	4.50
2544	Zinc Bath Tray, for washing copies, 42 x 30 inches . .	6.00	6.00
	Felt, $\frac{1}{4}$ inch thick, for Print Frames, per square foot .	.25	.25

TIN TUBES WITH SCREW TOPS

FOR HOLDING PREPARED PAPER, TRACINGS, DRAWINGS, ETC.

No.		PRICE	Post
2546	Plain Tin Tube, screw top, 24 x 2 $\frac{1}{4}$ inches . .	\$0.80	\$0.80
2547	Plain Tin Tube, screw top, 30 x 2 $\frac{1}{4}$ inches . .	.95	.35
2548	Plain Tin Tube, screw top, 36 x 2 $\frac{1}{4}$ inches . .	1.00	.40
2549	Plain Tin Tube, screw top, 42 x 2 $\frac{1}{4}$ inches . .	1.10	.45

TOWNSHIP PLOTTING PAPER

No.		PRICE	Post
2550	Township Plotting paper, Rulings 6 x 6 inches, blocks 1 inch square, per quire	\$1.00	\$0.18
2552	Township Plotting paper, Rulings 12 x 12 inches, blocks 2 inches square, per quire . .	2.00	.35
2553	Township Plotting paper, Rulings 18 x 15 inches, per quire	3.00	.45

CROSS SECTION SKETCH BLOCKS

24 SHEETS

No.		PRICE	Post
2554	Sketch Block, 7 x 5 inches, ruled $\frac{1}{16}$ of an inch .	\$0.75	\$0.06
2555	Sketch Block, 10 x 7 inches, ruled $\frac{1}{16}$ of an inch	1.25	.12
2557	Sketch Block, 18 x 13 cm., metric ruling75	.06
2558	Sketch Block, 26 x 18 cm., metric ruling . . .	1.25	.12

PLAIN SKETCH BLOCKSEACH BLOCK CONSISTS OF 32 SHEETS OF BEST QUALITY
WHATMANS DRAWING PAPER

No.		PRICE	Post
2560	Sketch Block, 7 x 5 inches, unbound	\$0.50	\$0.08
2561	Sketch Block, 10 x 7 inches, unbound90	.16
2563	Sketch Block, 14 x 10 inches, unbound	1.60	.40
2565	Sketch Block, 20 x 14 inches, unbound	3.00	.70
2570	Sketch Block, 7 x 5 inches, bound	1.00	.12

PLAIN SKETCH BLOCKS

No.		PRICE	Post
2571	Sketch Block, 10 x 7 inches, bound	\$1.50	\$0.32
2573	Sketch Block, 14 x 10 inches, bound	2.50	.56
2575	Sketch Block, 20 x 14 inches, bound	4.50	

The unbound blocks have a stiff pasteboard backing.

The bound blocks have cloth sides and leather back, with a portfolio and loop for pencil inside. The portfolio will last for a number of blocks.

PORTFOLIOS

CLOTH SIDES, LEATHER BACK AND CORNERS

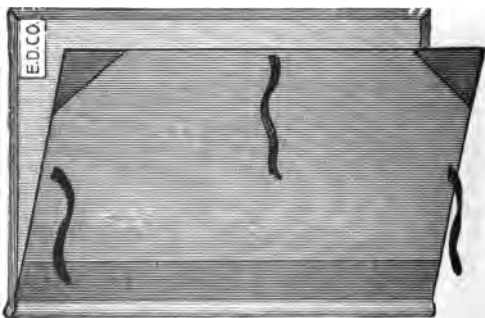

No. 2576

No.		PRICE
2576	Portfolio, 14 x 18 inches	\$1.50
2577	Portfolio, 17 x 22 inches	1.75
2578	Portfolio, 20 x 26 inches	2.25
2579	Portfolio, 23 x 31 inches	3.00

PROFILE PAPERS

SHEETS: Lines printed in green.

Continuous: Lines printed in green or orange.

Continuous on tracing paper or tracing cloth: Lines printed in orange.

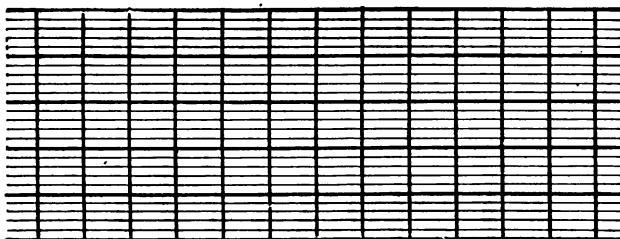

No. 2584

PLATE A. Rulings 4 x 20 to the inch

No.		PRICE	Post
2580	Plate A, sheet 42 x 15 inches, per quire	\$8.50	\$0.75
2581	Plate A, sheet 42 x 15 inches, per sheet40	.05
2584	Plate A, continuous, 20 inches wide, 50 yards in roll, per yard20	.05
2586	Plate A, continuous, 20 inches wide, mounted on muslin, 20 yards in roll, per yard60	.08
2588	Plate A, continuous, 20 inches wide, on tracing paper, 50 yards in roll, per yard20	.05
2589	Plate A, continuous, 20 inches wide, on tracing cloth, 20 yards in roll, per yard75	.08

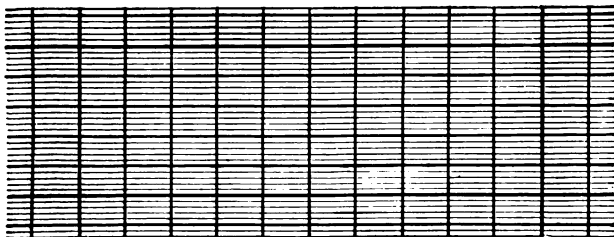

No. 2600

PROFILE PAPERS

PLATE B. Rulings 4 x 30 to the inch

No.		PRICE	POST
2595	Plate B, sheet 42 x 13½ inches, per quire . . .	\$8.50	\$0.75
2596	Plate B, sheet 42 x 13½ inches, per sheet40	.05
2600	Plate B, continuous, 20 inches wide, 50 yards in roll, per yard20	.05
2602	Plate B, continuous, 20 inches wide, mounted on muslin, 20 yards in roll, per yard60	.08
2604	Plate B, continuous, 20 inches wide, on tracing paper, 50 yards in roll, per yard20	.05
2605	Plate B, continuous, 20 inches wide, on tracing cloth, 20 yards in roll, per yard75	.08

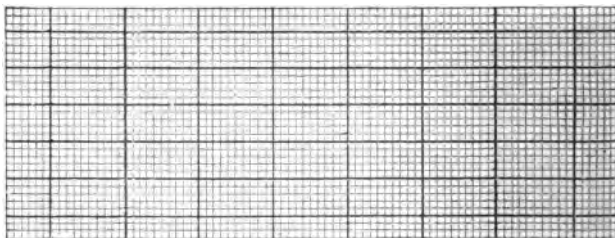

No. 2610

METRIC PROFILE PAPERS

No.		PRICE	POST
2610	In continuous roll, rulings 50 centimeters wide, in millimeters, with each fifth millimeter, each centimeter, and each decimeter proportion- ally heavier than the millimeters, 50 yards in roll, per yard	\$0.20	\$0.05
2612	Continuous, mounted on muslin, 20 yards in roll, per yard60	.08

CROSS SECTION PAPERS

Sheets: Lines printed in green.

Continuous: Lines printed in green.

Continuous on tracing paper or tracing cloth: Lines printed in orange.

No.		PRICE	POST
2620	Cross Section Paper, rulings 20 x 16 inches, 8 feet to inch, per sheet, 20 cents; per quire .	\$3.50	\$0.40

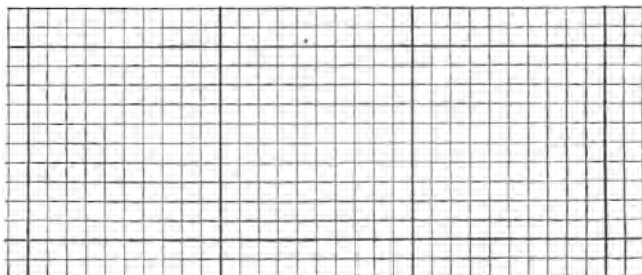

No. 2621

10 x 10 to the inch

2621	Cross Section Paper, rulings 20 x 16 inches, 10 feet to inch, per sheet, 20 cents; per quire .	3.50	0.40
2622	Continuous Cross Section Paper, 20 inches wide, in rolls of 50 yards, per yard20	.05
2623A	Continuous Cross Section Paper, 20 inches wide, ruled 10 feet to inch on tracing paper, in rolls of 50 yards, per yard20	.05
2623B	Continuous Cross Section Tracing Cloth, 20 inches wide, ruled 10 feet to inch, in rolls of 20 yards, per yard75	.08

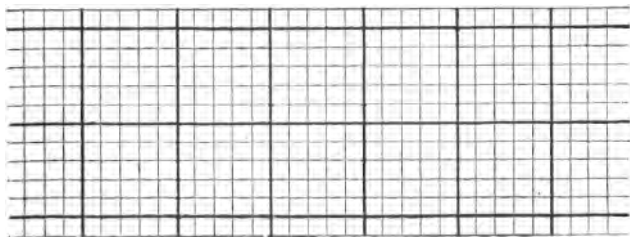

No. 2624

5 x 5 to the half inch

CROSS SECTION PAPERS		PRICE	Post
No. 2624	Cross Section Paper, rulings 20 x 16 inches, 10 feet to inch, every fifth line heavy, per sheet, 20 cents; per quire	\$3.50	\$0.40
2625	Cross Section Paper, rulings 20 x 16 inches, ruled 10 feet to inch on tracing paper, per sheet, 20 cents; per quire	3.50	.25
2626	Cross Section Paper, rulings 20 x 16 inches, 16 feet to inch, per sheet, 20 cents; per quire	3.50	.40
2627	Continuous Cross Section Paper, 20 inches wide, ruled 16 feet to inch in rolls of 50 yards, per yard20	.05
2630	Cross Section Paper, Metric, rulings every millimeter, size of sheet, 50 x 40 centimeters, per sheet, 20 cents; per quire	3.50	.40
2631	Continuous Cross Section Paper, Metric, rulings every millimeter, 50 centimeters wide, in rolls of 50 yards, per yard20	.05

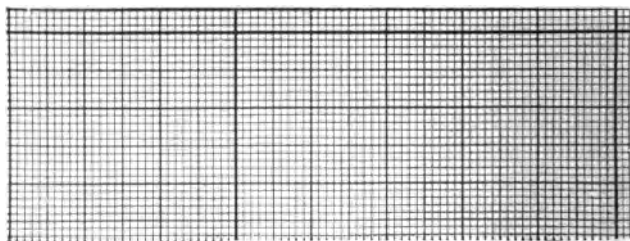

METRIC RULING

The following Cross Section Papers, being ruled, are much cheaper than those printed from copper plates:

2635	Ruled Cross Section Paper, 4 spaces to inch, 21 x 16 inches, per quire	\$1.00	\$0.35
2636	Ruled Cross Section Paper, 8 spaces to inch, 21 x 16 inches, per quire	1.00	.35
2637	Ruled Cross Section Paper, 10 spaces to inch, 21 x 16 inches, per quire	1.00	.35
2638	Ruled Cross Section Paper, 12 spaces to inch, 21 x 16 inches, per quire	1.00	.35
2645	Crowell's Adhesive Tape, either brown or white, 3/4 inch wide, for binding and mending drawings, per box of 50 feet25	.05

THUMB TACKS AND HORN CENTERS

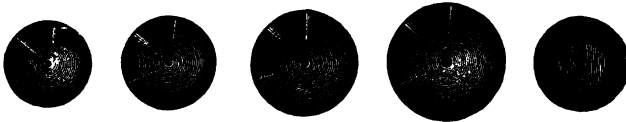

Nos. 2680 to 2690

No. 2708

No.		PRICE	POST
2680	Brass Thumb Tacks, round head, $\frac{1}{4}$ inch diam., per doz.	\$0.10	\$0.02
2681	Brass Thumb Tacks, round head, $\frac{3}{8}$ inch diam., per doz.	.15	.02
2682	Brass Thumb Tacks, round head, $\frac{1}{2}$ inch diam., per doz.	.25	.02
2684	German Silver Thumb Tacks, round head, $\frac{3}{8}$ inch diam., per doz.	.25	.02
2685	German Silver Thumb Tacks, round head, $\frac{1}{2}$ inch diam., per doz.	.30	.02
2686	German Silver Thumb tacks, round head, $\frac{5}{8}$ inch diam., per doz.	.45	.03
2689	German Silver Thumb Tacks, round head, superior, $\frac{1}{2}$ inch diam., per doz.	.70	.02
2690	German Silver Thumb Tacks, round head, superior, $\frac{5}{8}$ inch diam., per doz.	.90	.03
2692	Steel Thumb Tacks, common, $\frac{3}{8}$ inch diam., per doz.	.08	.02
2693	Steel Thumb Tacks, common, $\frac{3}{8}$ inch diam., per box of 100	.55	.05
2694	Steel Thumb Tacks, common, $\frac{1}{8}$ inch diam., per doz.	.12	.02
2695	Steel Thumb Tacks, common, $\frac{1}{8}$ inch diam., per box of 100	.80	.06
2700	Thumb Tack Lifter and Paper Knife, nickel plated	.20	.02
2703	Brass Paper Fasteners, round heads, prongs $\frac{1}{2}$ inch, per doz.	.05	.02
2705	Brass Paper Fasteners, round heads, prongs $\frac{1}{2}$ inch, per box of 100	.25	.06
2707	Horn Center, plain	.10	.01
2708	Horn Center with German silver rim	.50	.01
2710	Handy Paper Cutter, brass mounted, for cutting drawings from the board	.35	.03

CONTINUOUS PROFILE BOOKS

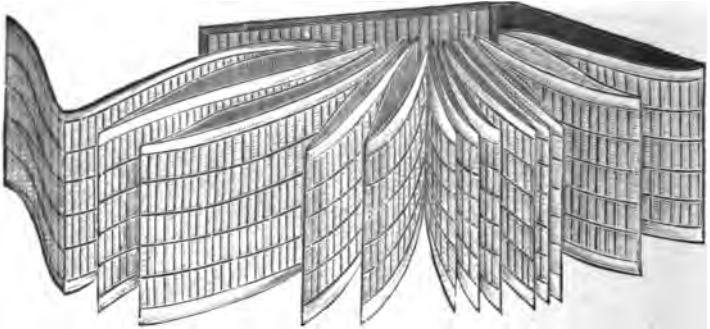

No. 2715

These books are for field or office purposes, being printed on a tough, thick paper, mounted upon a continuous piece of muslin and bound in book form with flexible morocco covers, convenient for the pocket. Each page will contain a profile of three thousand feet in length, so that each two pages facing will contain an average section of six thousand feet for a road as usually laid out for construction. Railroad and other engineers will find them very useful. The rulings correspond to our large profile plates A and B.

No.		PRICE	POST
2715	Plate A, about $8\frac{1}{2}$ x 6 inches, profile 12 miles .	\$2.00	\$0.16
2716	Plate A, about $8\frac{1}{2}$ x 6 inches, profile 25 miles .	3.25	.18
2717	Plate A, about $8\frac{1}{2}$ x 6 inches, profile 50 miles .	5.25	.22
2718	Plate A, about $8\frac{1}{2}$ x 6 inches, profile 100 miles .	9.50	.28
2720	Plate B, about 8 x $5\frac{1}{4}$ inches, profile 12 miles .	2.00	.15
2721	Plate B, about 8 x $5\frac{1}{4}$ inches, profile 25 miles .	3.25	.17
2722	Plate B, about 8 x $5\frac{1}{4}$ inches, profile 50 miles .	5.25	.20
2723	Plate B, about 8 x $5\frac{1}{4}$ inches, profile 100 miles .	9.50	.25

PLAT AND PROFILE BOOK

This book is $9\frac{1}{2}$ x $4\frac{1}{4}$ inches, oblong, with flexible morocco cover, containing 36 profile pages, plate B, and the opposite pages are blank for plats, etc. The book has also valuable tables.

No.		PRICE	POST
2724A	Dunham's Plat and Profile book	\$1.00	\$0.15

ENGINEERS BLANK FIELD BOOKS
LEATHER BINDING AND ROUNDED CORNERS

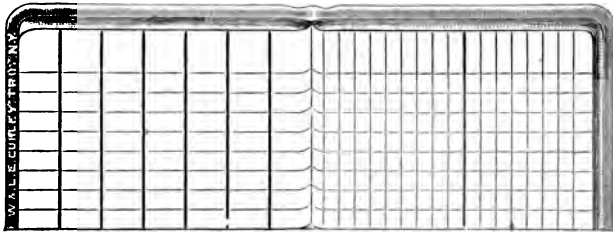

No.		PRICE	POST
2725	Level books, $4\frac{1}{4} \times 6\frac{3}{4}$ inches, 60 leaves, per dozen, \$5.00; or single	\$0.50	\$0.05



2728	Transit books, $4\frac{1}{4} \times 6\frac{3}{4}$ inches, 60 leaves, per dozen, \$5.00; or single50	.05
------	---	-----	-----

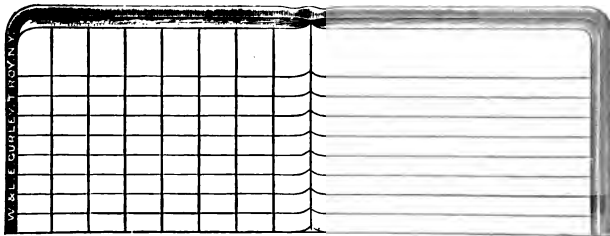

2731	Record books, $4\frac{1}{4} \times 6\frac{3}{4}$ inches, 60 leaves, per dozen, \$5.00; or single50	.05
------	--	-----	-----

BLANK FIELD BOOKS

No.		PRICE	POST
2736	Cross Section Books, $4\frac{1}{4} \times 6\frac{3}{4}$ inches, 60 leaves, ruled 5 spaces per inch, per doz., \$5.00; or single	\$0.50	\$0.05
2738	Cross Section Books, $4\frac{1}{4} \times 6\frac{3}{4}$ inches, 60 leaves, ruled 10 spaces per in., per doz., \$5.00; or single	.50	.05
2742	Cross Section Books, $6\frac{1}{2} \times 8\frac{1}{2}$ inches, 80 leaves, ruled 10 spaces per in., per doz., \$9.00; or single	.85	.08
2744	Earthworks Books, $5 \times 7\frac{3}{4}$ inches, 80 leaves, with printed headings and tables for R. R. Engineers, per dozen, \$10.00; or single	1.00	.18

LYONS TABLES

No.		
2746	Lyons Tables. A set of tables for finding at a glance the true cubical contents of Excavation and Embankment for the following Bases, and Ground and Slide Slopes. By E. M. Lyons, C. E.	
	Sheet No. 5. Base 15 feet, Slopes	$\frac{1}{4}$ to 1
	Sheet No. 19. Base 28 feet, Slopes	$\frac{1}{4}$ to 1
	Sheet No. 21. Base 30 feet, Slopes	$1\frac{1}{4}$ to 1
	Per sheet	15 cents, post. 5 cents.

The tables are printed in clear, bold type, on tinted paper, sheets 25 x 16 inches. They may be used by candle light without injuring the eyesight. Each sheet is complete in itself, and embraces all that is wanted in connection with Base or Slope designated, whether on level or side hill cross section.

Tables Nos. 1, 2, 3, 4, 6, 7, 8, 9, 10, 11, 12, 13, 14, 15, 16, 17, 18, 22, 23 and 24, quoted in our previous catalogues, are now out of print.

NOTE. — For clothbound Table Books of Earthworks, Excavations and Embankments, see page 516.

LEAD PENCILS. Black leads

No.		PRICE	POST
2750	Fabers Siberian, Hexagon, fine Drawing, Nos. 2 B to 8 H, per dozen	\$1.25	\$0.14
2751	Fabers best Castell, Hexagon, Nos. 2 B to 8 H. The highest grade Drawing Pencil, per dozen	1.25	.14
2752	Fabers Hexagon, Drawing, Nos. 1 to 5, per dozen	.75	.04
2754	Fabers Round, Drawing, Nos. 1 to 4, per dozen	.50	.04
2758	Fabers Round, Office Pencil, Nos. 2 and 3, with rubber tip, per dozen	.50	.04
2765	Fabers Artists Pencil, with movable lead, H to 6 H, each	.25	.02
2768	Fabers Siberian Leads, H to 6 H, for Artists Pencil, 6 in box, per box	.60	.04

These leads fit the pencil legs of modern Drawing Compasses.

LEAD PENCILS

No.		PRICE	POST
2770	Fabers Siberian Round Pencils, 5 in box, 2 B to H, per box	\$0.50	\$0.04
2771	Fabers Siberian Round Pencils, 7 in box, 3 B to 2 H, per box65	.05
2772	Fabers Siberian Round Pencils, 10 in box, 4 B to 4 H, per box90	.08
2774	Fabers Siberian Round Pencils, 5 in box, with knife and rubber, per box75	.05
2778	Hardtmuths Koh-i-noor Pencils, Hexagon, Superfine, 2 B to 8 H, per dozen	1.25	.14
2780	Hardtmuths Mephisto, Copying, Round, No. 73 B, Violet, per dozen75	.04
2781	Hardtmuths Mephisto, Copying, Round, Red Tip, No. 77, Violet, per dozen85	.04
2784	Pencil Point Protector with rubber tip05	.01

COLORED PENCILS AND CRAYONS

No.		PRICE	POST
2785	Fabers Round, Red, Blue, Green and Yellow Pencils, per dozen	\$0.75	\$0.05
2790	Fabers Round, Wax Crayon Pencils, 6 in box, assorted colors, per box75	.05
2791	Fabers Round, Wax Crayon Pencils, 12 in box, assorted colors, per box	1.50	.18

LUMBER CRAYONS

FOR MARKING STAKES AND BOARDS



No. 2795

No.		PRICE	POST
2795	Venetian Crayons, dark red, per dozen	\$0.60	\$0.15
2796	Venetian Crayons, dark blue, per dozen60	.15
2797	Hexagon Lumber Crayons, waterproof, best quality, red, blue, or black, per dozen	1.20	.15

These crayons are superior quality and do not soil the hands.

*STEEL LETTERING AND WRITING PENS

No.		PRICE	Post
2800	Gillott's Mapping Pens, per dozen	\$0.60	\$0.03
2801	Gillott's Lithographic Pens, per dozen60	.03
2802	Gillott's Crow Quill Pens, per dozen60	.03
2803	French Crow Quill Pens, per dozen, on card35	.03
2806	Gillott's Mapping and Writing pens, No. 170, per dozen, 10 cents; per gross	1.00	.13
2807	Gillott's Mapping and Writing pens, No. 303, per dozen, 15 cents; per gross	1.50	.14
2808	Gillott's Mapping and Writing Pens, No. 404, per dozen, 10 cents; per gross	1.00	.14
2810	Falcon Writing Pens, No. 048, per dozen, 10 cents; per gross75	.04
2812	Office Writing Pens, fine quality, per dozen, 15 cents; per gross	1.50	.14
2814	Commercial Writing pens, per dozen, 10 cents; per gross75	.04
2816	Penholders, black swell handle, metal tip, for office use, per dozen50	.05

ROUND WRITING PENS, FOR ORNAMENTAL
LETTERING

No. 2820

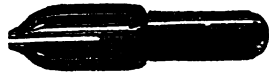

No. 2824

No.		PRICE	Post
2820	Pens, single pointed, Nos. 1 to 6, assorted, per dozen	\$0.12	\$0.02
2822	Pens, single pointed, Nos. 1 to 6, assorted, per gross	1.00	.15
2824	Pens, double pointed, Nos. 10, 20 and 30, as- sorted, per dozen35	.03
2826	Sample assortment of 25 Pens, per box35	.03
2827	Inkholder, for single pointed round writing pens, per box of 630	.03
2828	Penholders for round writing pens, each10	.02
2830	Textbook to round writing, with full instructions65	.05
2831	Copybook for round writing practice35	.05

**STEEL ERASING KNIVES, ERASING SHIELDS,
PENCIL SHARPENERS AND FILES**

No.		PRICE	POST
2835	Steel Blade Eraser, Cocoa handle	\$0.35	\$0.03
2836	Steel Blade Eraser, Bone handle50	.03
2838	Steel Eraser, long knife blade, Cocoa handle45	.03
2839A	Metal Erasing Shield, nickel plated, 3¾ x 2¾ in.20	.02
2839B	Zylonite Erasing Shield, 4½ x 2½ inches20	.02

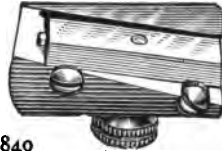
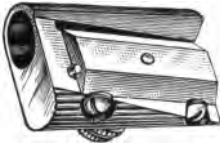

No. 2840

2840	Fabers Pencil Sharpener (superior)25	.03
2843	Fine Steel Pencil File, with sheath25	.03
2844	Fine Steel Pencil File, with Tack lifter at end.25	.03
2846	Pencil Pointer (a pad of flint paper) 1¼ x 4 in.10	.02

ERASING RUBBERS



No. 2852

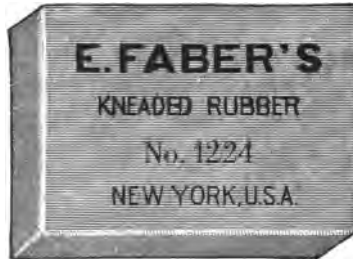

No. 2859

No.		PRICE	POST
2850	Fabers Artists Rubber, No. 40, Janus	\$0.06	\$0.01
2852	Fabers Artists Rubber, No. 24, "10	.02
2854	Fabers Artists Rubber, No. 16, "15	.03
2856	Fabers Artists Rubber, No. 12, "20	.03
2858	Fabers Kneaded Rubber, 1¼ x 1¾ inch05	.01
2859	Fabers Kneaded Rubber, 1½ x 1¼ inches10	.02

ERASING RUBBERS



No. 2861

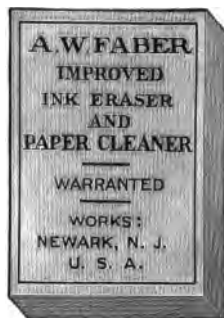

No. 2862

No.		PRICE	POST
2861	Fabers Circular Ink Eraser	\$0.05	\$0.01
2862	Fabers Ink Eraser, $1\frac{1}{2}$ x 1 inch05	.01
2864	Fabers Ink Eraser, $1\frac{1}{8}$ x $1\frac{1}{2}$ inches20	.03



No. 2858

No.		PRICE	POST
2866	Fabers Combined Ink and Pencil eraser, $2\frac{1}{4}$ x 1 inch	\$0.15	\$0.02
2867	Fabers combined Ink and Pencil eraser, $2\frac{1}{2}$ x $1\frac{3}{8}$25	.03
2868	Fabers Typewriters Eraser, $3\frac{1}{4}$ x $\frac{5}{8}$ inch10	.02
2872	Art Gum, for cleaning drawings, 2 x 1 inch07	.02
2873	Art Gum, for cleaning drawings, $2\frac{1}{4}$ x $1\frac{1}{8}$ inches10	.03

ERASING RUBBERS



Nos. 2880 to 2885

No.		PRICE	Post
2880	Bevel Rubber, green, oblong, No. 48	\$0.06	\$0.01
2881	Bevel Rubber, red, oblong, No. 4806	.01
2882	Bevel Rubber, green, oblong, No. 2412	.02
2883	Bevel Rubber, red, oblong, No. 2412	.02
2884	Bevel Rubber, green, oblong, No. 1220	.03
2885	Bevel Rubber, red, oblong, No. 1220	.03



Nos. 2887 to 2889

2887	Hardtmuths Pliable Rubber, grey, flat, No. 30	.07	.01
2888	Hardtmuths Pliable Rubber, grey, flat, No. 20	.10	.02
2889	Hardtmuths Pliable Rubber, grey, flat, No. 12	.17	.03
	Hardtmuths Pliable Rubber, pink, at same prices		

SPONGE RUBBERS

FOR CLEANING DRAWINGS

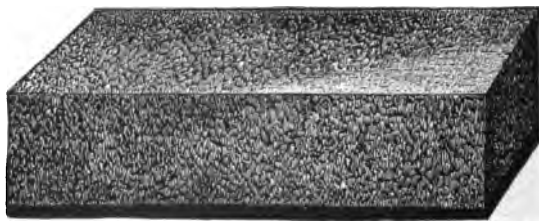

No. 2896

No.		PRICE	Post
2895	Sponge Rubber, $2\frac{1}{2} \times 1\frac{3}{4} \times \frac{5}{8}$ inch	\$0.30	\$0.02
2896	Sponge Rubber, $2 \times 2 \times 1$ inch30	.02
2898	Sponge Rubber, $4 \times 2 \times 1$ inch60	.04

RUBBER BANDS

No.		PRICE	Post
2900	Rubber Bands, No. 8, $\frac{7}{8} \times \frac{1}{16}$ inch, per gross . .	\$0.15	\$0.02
2901	Rubber Bands, No. 10, $1\frac{1}{4} \times \frac{1}{16}$ inch, per gross .	.18	.02
2902	Rubber Bands, No. 29, $1\frac{1}{2} \times \frac{1}{8}$ inch, per gross .	.65	.04
2903	Rubber Bands, No. 31, $2\frac{1}{2} \times \frac{1}{8}$ inch, per gross .	.80	.05
2904	Rubber Bands, No. 61, $2 \times \frac{1}{4}$ inch, per gross . .	1.00	.17
2905	Rubber Bands, No. 63, $3 \times \frac{1}{4}$ inch, per gross . .	1.50	.20
2907	Rubber Bands, No. 200, 11 sizes assorted, $1\frac{1}{8}$ to 3 inches, per box	1.25	.18

HIGGINS DRAWING BOARD MUCILAGE

No.		PRICE	Post
2915	Drawing board Mucilage, fine quality, 3 ounce jar	\$0.15	\$0.13
2916	Drawing board Mucilage, fine quality, 6 ounce jar25	.20
2918	Taurine Mucilage, fine quality, 2 ounce bottle, with brush10	.10
2919	Taurine Mucilage, fine quality, 4 ounce bottle, with brush20	.15

HIGGINS DRAWING BOARD MUCILAGE

No.		PRICE	POST
2920	Taurine Mucilage, fine quality, pint bottle, without brush	\$0.50	\$0.30

The Drawing Board Mucilage is a semi-fluid paste of great strength.

The Taurine Mucilage is a powerful liquid adhesive.



No. 2925



No. 2915

HIGGINS' AMERICAN LIQUID DRAWING INKS

No.		PRICE	No.	PRICE
2925	Waterproof Black Ink, small bottle	\$0.25		
2926	Waterproof Black Ink, 8 oz. bottle	2.00		
2928	General Black Ink (not waterproof), small bottle25		
2929	General Black Ink (not waterproof), 8 oz. bottle	2.00		
No.	PRICE	No.	PRICE	
2930	Waterproof Carmine \$0.25	2936	Waterproof Green . \$0.25	
2931	Waterproof Scarlet25	2937	Waterproof Yellow25	
2932	Waterproof Vermilion .25	2938	Waterproof Brown25	
2933	Waterproof Blue25	2939	Waterproof Orange25	
2934	Waterproof Indigo25	2940	Waterproof Brick	
2935	Waterproof Violet25		Red25	
2942	Waterproof Ink, any of the above colors, per 8 oz. bottle		2.00	
2943A	Higgins Eternal Black Writing Ink, small bottle10	
2943B	Higgins Black Engrossing Ink, small bottle20	

Postage on the above inks, 7 cents each small bottle, and 30 cents each 8 oz. bottle.

2944 Metal Ink Bottle Stand with spring clutch, fitted to hold three small bottles of Higgins Inks. If mailed, add 10 cents for postage35

WINSOR & NEWTONS WATER COLOR LIQUIDS

No.	PRICE	No.	PRICE
2945	India Ink, Black . . \$0.30	2950	Silver Ink \$0.30
2946	Chinese White.30	2951	Gold Ink30
2947	Carmine30	2952	Indelible Brown30
2948	Sepia30	2953	Prout's Brown30
2949	Prussian Blue30	2954	Extract of Ox Gall30

Postage on the above inks, 7 cents each bottle.

MISCELLANEOUS LIQUID DRAWING INKS

No.		PRICE	POST
2955	Devoes White Ink, per bottle	\$0.25	\$0.08
2956	Bourgeois Black India Ink, per bottle25	.06
2958	Box of Indelible Drawing Inks, six bottles (Blue, Brown, Carmine, Green, Scarlet, Yellow), per box	1.50	.35
2959	Winsor & Newtons Waterproof Drawing Inks (Black, Brown, Carmine, Emerald Green, Indigo, Vermilion, Yellow), per bottle25	.06

CHINESE INDIA INK FOR GENERAL DRAWING



No. 2968

No.		PRICE	POST
2960	Round, Black, Lion Head, $2\frac{1}{2}$ inches, per cake	\$0.15	\$0.02
2962	Oval, Black, Lion Head, $3\frac{1}{4}$ inches, per cake	.25	.02
2963	Round, Black, Lion Head, $4\frac{1}{4}$ inches, per cake	.50	.04
2967	Square, Black, Super Super, $3 \times \frac{1}{2}$ inch, per cake	.50	.03
2968	Square, Black, Super Super, $3\frac{3}{4} \times \frac{5}{8}$ inch, per cake	1.00	.14
2970	Oblong, Black, Double Dragon, fine, $3\frac{5}{8} \times \frac{7}{8}$ inch, per cake	2.00	.14
2971	Oblong, Dead Black, for Photo Drawing, $3\frac{1}{2} \times \frac{7}{8}$ inch, per cake	1.00	.14
2972	Oblong, Red Ink, fine, $2\frac{3}{4}$ inches, per cake	.50	.03
2973	Oblong, Blue Ink, fine, $2\frac{3}{4}$ inches, per cake	.50	.03
2974	Oblong, Yellow Ink, fine, $2\frac{3}{4}$ inches, per cake	.50	.03

JAPANESE INDIA INK

For drawings in which the ink lines are washed in applying colors.



No. 2980

No.		PRICE	POST
2980	Oblong, black, fine quality, small cake	\$1.00	\$0.14
2982	Oblong, black, fine quality, medium cake	2.00	.14
2984	Oblong, black, fine quality, large cake	3.00	.15

WINSOR & NEWTONS WATER COLORS

MOIST IN CHINA PANS, OR HARD COLORS IN CAKES

The moist colors are usually preferred, as they do not waste by crumbling



WHOLE CAKE



HALF CAKE



WHOLE PAN



HALF PAN

No.

2990 Whole, each, 25 cts.; Half, each, 15 cts.

1 Antwerp Blue	20 Indian Red	33 Prussian Blue
6 Brown Ochre	21 Indigo	34 Prussian Green
8 Burnt Sienna	22 Italian Pink	35 Raw Sienna
9 Burnt Umber	23 Ivory Black	36 Raw Umber
10 Chinese White	26 Light Red	40 Vandyke Brown
11 Chrome Yellow	27 Naples Yellow	41 Venetian Red
13 Deep Chrome	28 Neutral Tint	42 Vermilion
15 Emerald Green	29 New Blue	43 Yellow Lake
17 Gamboge	30 Olive Green	44 Yellow Ochre
18 Hookers Green No. 1	31 Orange Chrome	
19 Hookers Green No. 2	32 Paynes Gray	

2992 Whole, each, 45 cts.; Half, each, 25 cts.

46 Brown Madder	51 Neutral Orange	55 Scarlet Lake
47 Cerulean Blue	62 Orange Vermilion	56 Scarlet Vermilion
49 Crimson Lake	52 Purple Lake	57 Sepia
60 Indian Yellow		58 Warm Sepia

2994 Whole, each, 65 cts.; Half, each, 35 cts.

59 Cobalt Blue	61 Lemon Yellow	79 Pure Scarlet
97 Cobalt Green		63 Violet Carmine

2996 Whole, each, 90 cts.; Half, each, 45 cts.

70 Carmine	78 Pink Madder	80 Rose Madder
81 Madder Carmine	82 Purple Madder	90 Scarlet Madder

Postage on Water Colors, 1 cent each.

The following colors are generally used by Architects and Civil and Mechanical Engineers:

Burnt Umber to represent earth.
Burnt Sienna to represent wood.
Light Red to represent brick.
Sepia and Yellow Ochre to represent stone.
Prussian Blue to represent wrought iron.
Paynes Gray to represent cast iron.
Gamboge to represent brass.
Gamboge and Carmine to represent copper.
Prussian Blue and Carmine to represent steel.

In Topography the following colors are generally used:

Hookers Green No. 2 to represent grass.
Burnt Sienna to represent cultivated ground.
Burnt Sienna and Hookers Green to represent uncultivated ground.
Indigo and Hookers Green to represent swamp.
Gamboge and Hookers Green to represent trees.
Yellow Ochre to represent roads and streets.
Indigo to represent water.
Carmine to represent buildings, bridges and masonry.
Sepia to represent hills.
Sepia to represent shade lines and shadows.



No. 3000

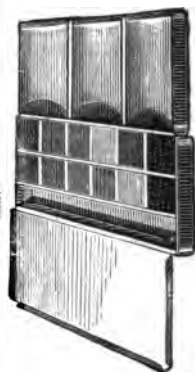

No. 3010

WINSOR & NEWTONS WATER COLORS

IN POLISHED MAHOGANY BOX, WITH LOCK AND KEY, AND
DRAWER, PAINT STONE, WATER GLASS, INDIA INK,
BRUSHES AND COLORS

No.		PRICE	POST
3000	Complete Box, with 12 colors, whole cakes . .	\$9.00	\$1.00
3002	Complete Box, with 18 colors, whole cakes . .	13.50	1.15
3004	Complete Box, with 12 colors, half cakes . . .	6.00	.50
3006	Complete Box, with 18 colors, half cakes . . .	7.75	.65

EMPTY JAPANED TIN COLOR BOXES

No.		PRICE	POST
3010	Japanned Box, to hold 6 whole or 12 half pans .	\$0.80	\$0.06
3011	Japanned Box, to hold 10 whole or 20 half pans	1.00	.17
3012	Japanned Box, to hold 12 whole or 24 half pans	1.15	.18
3013	Japanned Box, to hold 16 whole or 32 half pans	1.30	.20
3014	Japanned Box, to hold 18 whole or 36 half pans	1.40	.22

WATER COLOR BRUSHES

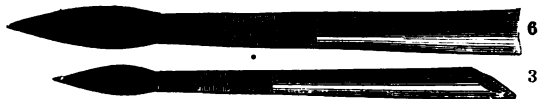

6
3

Nos. 3020 and 3025

No.

3020 Camel Hair in Quills:

No.	1	2	3	4	5	6	7	8	Post
Each,	\$0.05	.05	.06	.06	.08	.08	.10	.10	\$0.01

3025 Red Sable in Quills:

No.	1	2	3	4	5	6	7	8	Post
Each,	\$0.12	.15	.20	.25	.30	.35	.50	.60	\$0.01



4
3

No. 3030

3030 Camel Hair in Tin, with handle:

No.	1	2	3	4	5	6	Post
Each,	\$0.06	.08	.08	.10	.10	.12	\$0.02

3035 Red Sable, in Albata, with handle:

No.	1	2	3	4	5	6	7	13	14	Post
Each,	\$0.20	.25	.35	.45	.55	.65	.75	1.00	1.30	\$0.02 to \$0.12



3

No. 3040

3040 Camel Hair Sky or Wash Brush, in Tin, with handle:

No.	0	1	2	3	4	Post
Each,	\$0.18	.20	.25	.35	.45	\$0.02

3045 Camel Hair Wash Brushes in Tin, with two points:

No.	0	1	2	3	Post
Each,	\$0.35	.40	.50	.60	\$0.02

WATER GLASSES, INK AND COLOR SLABS



No. 3050

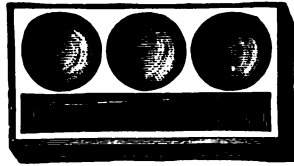

No. 3054

No.		PRICE	POST
3050	Artists Water Glass, $2\frac{3}{8}$ inches	\$0.12	\$0.08
3051	Artists Water Glass, $2\frac{3}{4}$ inches20	.10
3052	Artists Water Glass, $3\frac{1}{4}$ inches25	.10
3054	Ink or Color Slab, $2\frac{3}{4}$ x $1\frac{1}{2}$ inches10	.04
3055	Ink or Color Slab, $3\frac{5}{8}$ x $2\frac{3}{8}$ inches15	.06
3056	Ink or Color Slab, 4 x $2\frac{1}{2}$ inches25	.10
3057	Ink or Color Slab, $4\frac{1}{2}$ x $2\frac{3}{4}$ inches30	.15
3065	Slate Ink Slab, $3\frac{1}{2}$ x $3\frac{1}{2}$ inches, with glass cover35	.15
3067	Opal Glass Ink Saucer, with cover, $3\frac{1}{4}$ inches50	.15

PATENT INK SLAB

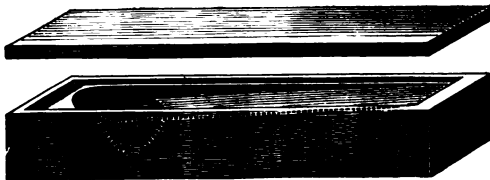

No. 3070

No.		PRICE	POST
3070	Patent Ink Slab, China, with cover, $4\frac{1}{2}$ x $1\frac{3}{4}$ inches	\$0.35	\$0.10
3071	Patent Ink Slab, China, with cover, $5\frac{1}{4}$ x $2\frac{1}{8}$ inches40	.15

COLOR SAUCERS

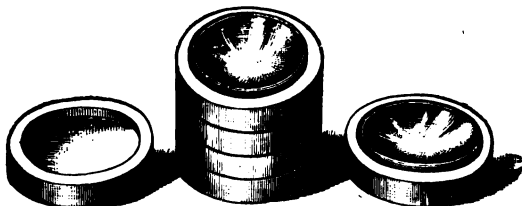

No. 3075

No.		PRICE	POST
3075	Nest of 5 Saucers and a cover, 2 ³ / ₈ inches, per nest	\$0.45	\$0.15
3076	Nest of 5 Saucers and a cover, 2 ⁵ / ₈ inches, per nest	.55	.20
3077	Nest of 5 Saucers and a cover, 3 ¹ / ₄ inches, per nest	.65	.28
3078	Nest of 5 Saucers and a cover, 3 ³ / ₄ inches, per nest	.75	.35

BRASS STENCILS. ALPHABETS AND FIGURES

No.	Height of Letters	1/4 in.	3/8 in.	1/2 in.	5/8 in.	3/4 in.	1 in.
3100	Stencil Alphabet	\$1.00	\$1.15	\$1.30	\$1.50	\$1.75	\$2.00
3101	Stencil Alphabet	1.85	2.00	2.15	2.30	2.50	2.75
3102	Stencil Alphabet	4.00	4.15	4.30	4.50	4.75	5.00
3103	Stencil Alphabet	1.85	2.00	2.15	2.30	2.50	2.75

A set of Figures to match any of these Alphabets will cost one third the price of the same style and size of Alphabet.

Postage on Alphabets	\$0.14 to \$0.17
Postage on each set of Figures, Nos. 3100, 3101 and 3103	.04
Postage on each set of Figures, No. 3102	.14

BRASS STENCIL PLATES

No.		PRICE	POST
3110	North Point, full size	\$0.50	\$0.02
3111	North Point, full size	.75	.02
3112	North Point, full size	.60	.02
3115	Ornamental Corner, full size	1.00	.12
3116	Ornamental Corner, full size	.75	.03
3120	Dasher, full size	.25	.02
3121	Dasher, full size	.25	.02

A Stencil Brush is furnished without extra charge.

Use thick India ink for marking.

See cut of Stencils on page 462

STENCIL ALPHABETS, FIGURES AND PLATES

EMMA 43

3100

3101

3102

3103

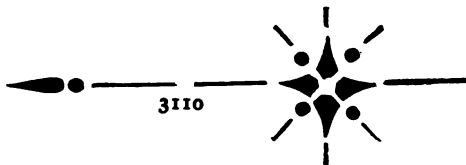

3110

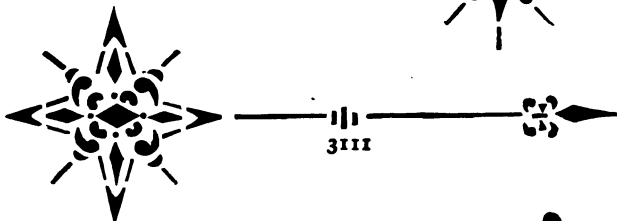

3111

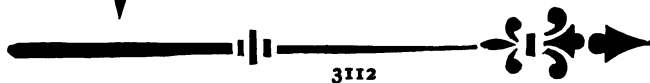

3112



3113

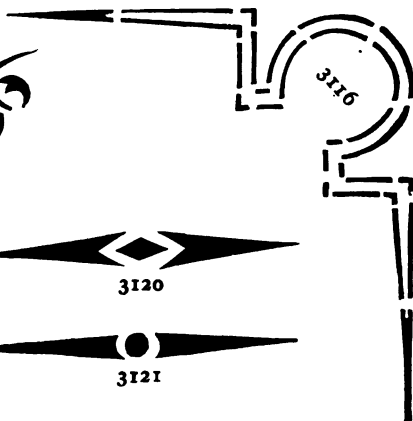

3116



3120



3121

MAGNETIC POCKET COMPASSES



No. 3154



No. 3160

No.		PRICE	POST
3154	Government pattern, mahogany case, 3 inches square, raised ring, 0° to 360°, superior 2 inch needle with stop, Gurley, maker	\$4.00	\$0.16
3155	Compass, like No. 3154, but with raised ring 0° to 90° each way, 3¾ inches square and 2½ inch needle, Gurley, maker	5.00	.18
3160	Brass, round, watch pattern, stop, agate center, 1½ inches diameter85	.04
3161	Brass, round, watch pattern, stop, agate center, 2 inches diameter	1.00	.14
3164	Brass, round, stop, agate center, 1½ inches diameter, with cover	1.10	.14
3165	Brass, round, stop, agate center, 2 inches diameter, with cover	1.25	.14

MAGNETIC POCKET COMPASSES



No. 3164



No. 3166



No. 3168

MAGNETIC POCKET COMPASSES

No.		PRICE	POST
3166	Brass, round, automatic stop, agate center, $2\frac{1}{2}$ in. diameter, with reversible cover (superior)	\$2.50	\$0.15
3168	Brass, round, watch pattern, stop, agate center, $1\frac{1}{2}$ inches diameter, with hinged cover	1.25	.14
3170	Brass, round, watch pattern, stop, agate center, 2 inches diameter, with hinged cover	1.50	.14

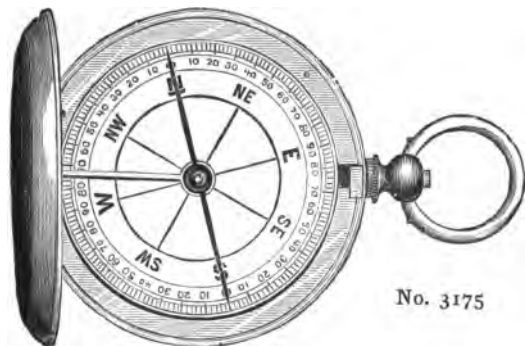

3175	Pocket Compass, $1\frac{3}{4}$ inches diameter, hunting case, spring catch, stop to needle in joint of cover, and bar needle with agate center	3.20	.14
3176	Pocket Compass, 2 inches diameter, hunting case, spring catch, stop to needle in joint of cover, and bar needle with agate center	4.00	.15

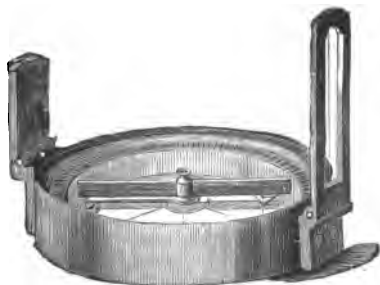

MAGNETIC POCKET COMPASSES

No.		PRICE	POST
3182	Pocket Compass, $2\frac{1}{2}$ inches diameter, with cover, folding sights, raised ring, bar needle with agate center, and stop to needle	\$6.00	\$0.15
3183	Pocket Compass, 3 inches diameter, with cover, folding sights, raised ring, bar needle with agate center, and stop to needle	7.50	.16

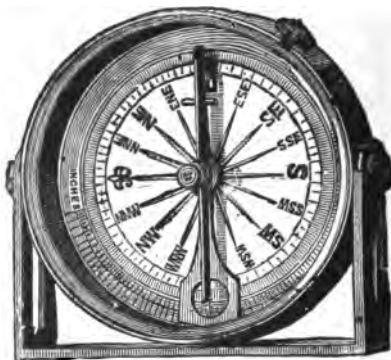

No. 3186 As Clinometer

3186	Clinometer Compass, $2\frac{1}{2}$ inches diameter, graduated to one degree, bar needle with agate center and stop, pivoted sights to swing over compass face, and morocco case	7.25	.16
3187	Clinometer Compass, 3 inches diameter, graduated to one degree, bar needle with agate center and stop, pivoted sights, and morocco case	8.75	.18
3188	Pocket Compass, $3\frac{3}{8}$ inches diameter, heavy brass case and cover, raised ring, $2\frac{1}{2}$ inch needle with agate center and stop, superior, Gurley, maker	6.00	.20
3192	Pocket Compass, $1\frac{3}{4}$ inches diameter, watch pattern, stem stop, Singer's patent pearl dial	3.85	.14
3194	Geological Compass, $2\frac{3}{4}$ inches diameter, with pendulum, for ascertaining the angle of dip in rocks	4.25	.15
3200	Pocket Compass, watch pattern, $2\frac{1}{2}$ inches diameter, hunting case, raised ring, agate center, stop to needle, folding sights	5.50	.16

BRUNTON POCKET TRANSIT



No. 3215

<p>No. 3215</p>	<p>Brunton Pocket Transit. Designed for civil and mining engineers, mine managers and geologists. Can be used as a prismatic compass, sighting compass, clinometer and Abney Level. Aluminum case. Size $2\frac{3}{4} \times 2\frac{3}{4} \times 1$ inch. Weight 8 ounces</p>	<p>PRICE POST</p> <p>\$25.00 \$0.25</p>
-----------------	--	--

POCKET ALT AZIMUTH

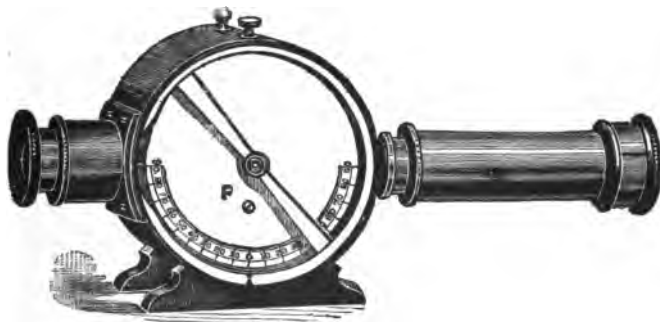

No. 3220

<p>No. 3220</p>	<p>Pocket Alt Azimuth, with Telescope, for travelers and military surveyors. Altitudes, azimuths, compass bearings, clinometer degrees and levels are all obtained by this instrument. Size $6\frac{1}{2} \times 2\frac{1}{2} \times 1\frac{1}{8}$ inches, in case</p>	<p>PRICE POST</p> <p>\$50.00 \$0.40</p>
-----------------	---	--

PRISMATIC COMPASSES

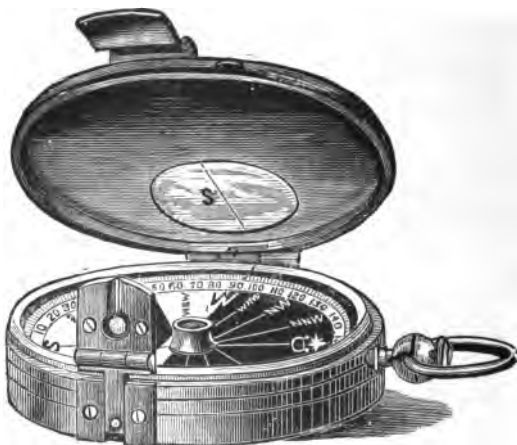

No. 3225

No.		PRICE	Post
3225	Prismatic Compass, $2\frac{1}{8}$ inches diameter, hunting case; can be used as an ordinary compass without opening the cover, and a prismatic compass by raising the cover; glazed with a stout glass, on which is etched a line for the sight. With folding prism and floating card dial with stop	\$15.00	\$0.16
3226	Prismatic Compass, 3 inches diameter, with floating metal ring, jewelled center, azimuth glasses, folding prism and folding sight with hinged mirror, in leather sling case	28.00	.25
3227	Prismatic Compass, 3 inches diameter, with floating card dial, jewelled center, folding prism and folding sight, in leather sling case	16.00	.20

PRISMATIC COMPASSES



No. 3226



No. 3227

<p>No. 3228</p>	<p>Prismatic Compass, 3 inches diameter, with floating metal ring, jewelled center, folding prism and folding sight, in leather sling case</p>	<p>PRICE POST</p> <p>\$21.00 \$0.20</p>
----------------------------	--	--

PRISMATIC COMPASSES

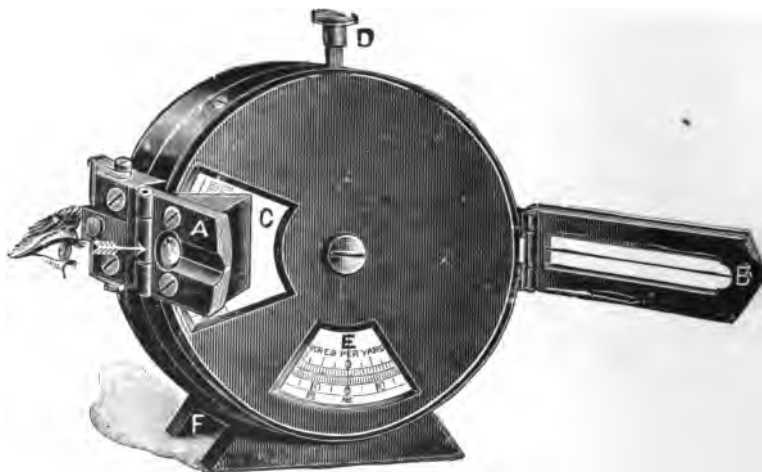

No. 3230

No.		PRICE	POST
3230	Prismatic Compass, Barker's Patent, $2\frac{3}{4}$ inch floating dial, agate center with stop, mounted beneath $2\frac{3}{4}$ inch pendulum dial, graduated for altitudes 0° to 180° , also graduated 0° to 90° both ways as clinometer and with scale of rise or fall in inches per yard; folding prism and hair sight, metal case, and in leather sling case	\$27.00	\$0.25
3232	Prismatic Compass, 3 inches diameter, with metal dial graduated to $\frac{1}{2}$ degrees, agate center with stop, folding prism, azimuth glasses, folding sight with hinged and sliding mirror, metal cover, in leather sling case . . .	25.00	

SEXTANTS

No.		PRICE
3245	Sextant of gun metal, $4\frac{1}{2}$ inches radius, arc of 150° graduated on silver to 15 minutes with vernier to 15 seconds, clamp and tangent and magnifier, one terrestrial telescope, one celestial telescope, one sight tube, six neutral glasses, two mirrors in mahogany box	\$50.00
3247	Sextant of gun metal, $6\frac{1}{2}$ inches radius, arc of 150° graduated on silver to 10 minutes with vernier to 10 seconds, clamp and tangent and magnifier, two celestial telescopes, one terrestrial telescope, one sight tube, seven neutral glasses, two mirrors, in mahogany box	80.00
3248	Sextant of gun metal, superior, 7 inches radius, arc of 150° graduated on silver to 10 minutes with vernier to 10 seconds, clamp and tangent and magnifier, two celestial telescopes, one terrestrial telescope, one sight tube, seven neutral glasses, two mirrors, in mahogany box	100.00

ARTIFICIAL HORIZONS

No.		PRICE	POST
3250	Artificial Horizon, with black glass plane mounted in brass frame, with three leveling screws, and sensitive level vial. All in mahogany box	\$16.00	\$0.30



No. 3252

3252	Mercurial Horizon, iron trough, iron bottle with screw stopper and funnel cap, glazed metal roof. All in mahogany box	30.00
------	---	-------

ANGLE MIRRORS, PRISMS AND RANGE FINDER



No. 3256



No. 3260

No		PRICE	POST
3255	Angle Mirror, with small plummet, for angles of 90°. The handle can be detached and stored in frame of instrument. Size, 2¼ x 2 x 1¾ inches, in morocco case	\$7.50	\$0.15
3256	Angle Mirror, plain, for angles of 90°, in morocco case	5.00	.15
3260	Rectangular Prism, for angles of 90°, 2½ x 1¼ x 1½ inches, in morocco case	5.00	.12
3262	Double Prism, to take angles of 90° and 45°, in morocco case	10.00	.12
3264	Penta Prism Range Finder, brass mounted, in leather case, with directions. Distances up to two miles easily determined	10.00	.25

SURVEYORS CROSS STAFF HEADS

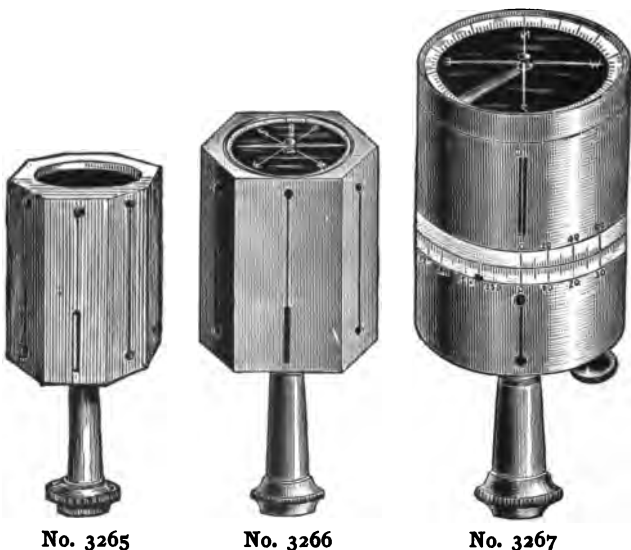

No. 3265

No. 3266

No. 3267

No.		PRICE	Post
3265	Surveyors Cross Staff Head, for 45° and 90° angles. Octagonal, 2½ inches long. With staff socket	\$2.75	\$0.30
3266	Surveyors Cross Staff Head, for 45° and 90° angles. Octagonal, 3 inches long. With magnetic compass, 1¼ inch needle, and with staff socket	4.75	.35
3267	Surveyors Cross Staff Head, for 45° and 90° angles. Round, 3¾ inches long. With vertical axis graduated to 1° and vernier to 2 minutes. With magnetic compass, 2⅛ inch needle, and with staff socket	11.50	.40

PEDOMETERS AND PASSOMETERS



No. 3276

No.		PRICE	POST
3270	Pedometer, watch form, with automatic stem attachment to set the pointers to zero. Two dials register distance walked up to 100 miles by each $\frac{1}{4}$ mile	\$4.50	\$0.14
3272	Pedometer, watch form, with automatic stem attachment to set the pointers to zero. Three dials register distance walked up to 100 Miles by each 80 yards	5.25	.14
3276	Passometer, watch form, with automatic stem attachment to set the pointers to zero. Three dials register each step up to 25,000 steps . . .	6.00	.14
3277	Passometer, watch form, with automatic stem attachment to set the pointers to zero. Three dials register each step up to 100,000 steps . .	6.50	.14

With the Passometers, the distance walked is computed by multiplying the number of steps registered by the average length of stride.

TALLY REGISTERS AND ODOMETERS



No. 3280



No. 3281

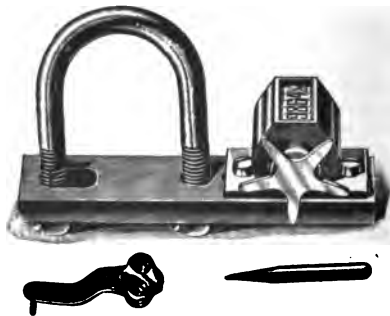

No. 3283

TALLY REGISTERS

No.		PRICE	POST
3280	Tally Register, for surveyors and others; useful in chaining, for counting persons, cattle, coal, wheat, etc. Registers to 999 and can be set to zero at will	\$2.50	\$0.16
3281	Tally Register, with 4 dials. Registers to 10,000, and can be set to zero at will	5.50	.16

ODOMETERS

No.		PRICE	POST
3282	Veeder Odometer, or Revolution Counter, with fixtures for attaching	\$3.50	\$0.18
	This Odometer is like the cut of No. 3283 in appearance, but registers on the dial only every fifth revolution of the carriage wheel. To ascertain the distance traveled, multiply the registered number of revolutions by five and that product by the circumference of the wheel. This Odometer can be used with carriage wheels of any diameter.		
3283	Veeder Regular Odometer, with fixtures for attaching	3.50	.18

This Odometer registers the distance traveled in miles and fractions of a mile, and is designed for attaching to left front or left rear axles. Mention the wheel size of your vehicle when ordering No. 3283.

CLINOMETERS

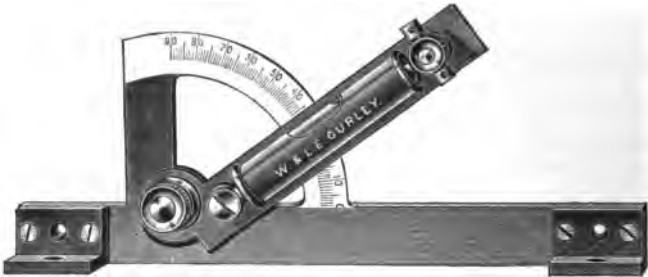

No. 3284

No.		PRICE	POST
3284	Clinometer or Slope Level, Gurley, maker, 7 in. long, arc to whole degrees, in wood case . . .	\$8.00	\$0.30

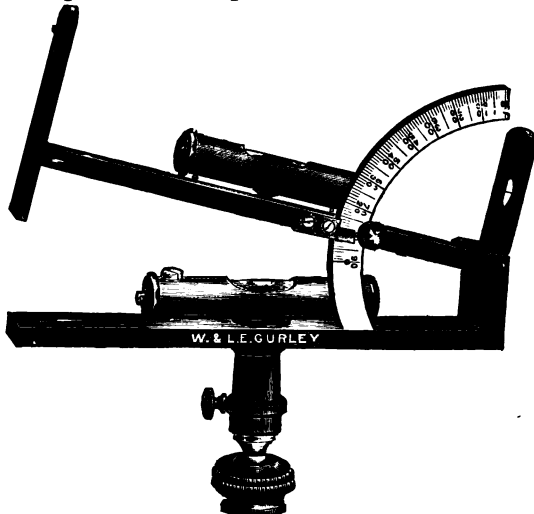

No. 3288

3288	Clinometer or Slope Level, Gurley, maker, 6 inches long, arc to whole degrees, two levels, sights and staff mountings, in wood case . . .	16.00	.50
------	---	-------	-----

CLINOMETERS



No. 3290

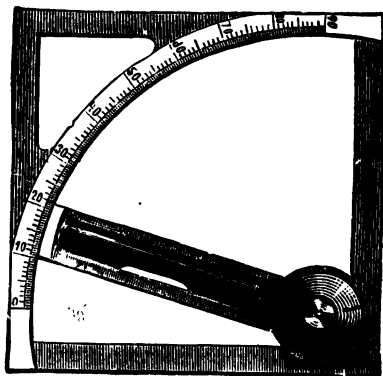

No. 3292

No.		PRICE	POST
3290	Boxwood Clinometer, 12 inch, folding to 6 inch, with two levels, compass, inclination scale, and sights, in leather case	\$12.00	\$0.20
	The inclination scale gives the value of any angle. The angle, ascertained from the graduated arc, refers to that degree in the column marked "angle," and another column gives the rise or fall in any given distance.		
3292	Clinometer or Slope Level, brass frame, 4 inches square, arc to whole degrees and vernier to 5 minutes. The design renders the measurement of the inclination of the under side of a plane available, as any of the four edges may be used; in case	10.00	.40

ANEROID BAROMETERS

FOR ASCERTAINING HEIGHTS, DIFFERENCES OF LEVEL AND
METEROLOGICAL CHANGES, APPROACH OF STORMS, ETC.

Mountain Aneroid Barometers, compensated for temperature
with gilt cases and silvered dials, in morocco cases.



No. 3316

With the exception of Nos. 3336 to 3340, all the Barometers mentioned on pages 481 to 483 are furnished with a rating card, showing the result of tests in comparison with our standard mercurial barometer.

A Treatise on the Aneroid Barometer; its construction and use. Illustrated. 50 cents.

ANEROID BAROMETERS

No.		PRICE	POST
3300	Pocket Aneroid, $1\frac{3}{4}$ inches diameter, altitude scale to 3,000 feet, by each 10 feet	\$19.00	\$0.20
3301	Pocket Aneroid, $1\frac{3}{4}$ inches diameter, altitude scale to 5,000 feet, by each 20 feet	18.00	.20
3302	Pocket Aneroid, $1\frac{3}{4}$ inches diameter, altitude scale to 10,000 feet, by each 50 feet	19.00	.20
3303	Pocket Aneroid, $1\frac{3}{4}$ inches diameter, altitude scale to 16,000 feet, by each 100 feet	20.00	.20
3304	Pocket Aneroid, 2 inches diameter (nickeled hunting case and omitting morocco case), altitude scale to 8,000 feet, by each 50 feet.	22.00	.20
3310	Pocket Aneroid, $2\frac{1}{2}$ inches diameter, altitude scale to 3,000 feet, by each 10 feet	20.00	.25
3312	Pocket Aneroid, $2\frac{1}{2}$ inches diameter, altitude scale to 5,000 feet, by each 20 feet	19.00	.25
3314	Pocket Aneroid, $2\frac{1}{2}$ inches diameter, altitude scale to 10,000 feet, by each 50 feet	20.00	.25
3315	Pocket Aneroid, $2\frac{1}{2}$ inches diameter, altitude scale to 12,000 feet, by each 50 feet	21.00	.25
3316	Pocket Aneroid, $2\frac{1}{2}$ inches diameter, altitude scale to 16,000 feet, by each 50 feet	22.00	.25
3318	Pocket Aneroid, $2\frac{1}{2}$ inches diameter, altitude scale to 20,000 feet, by each 100 feet	23.00	.25
3322	Pocket Aneroid, $2\frac{1}{2}$ inches diameter, altitude scale to 10,000 feet, by each 50 feet, and thermometer	23.00	.25
3324	Pocket Aneroid, $2\frac{1}{2}$ inches diameter, altitude scale to 16,000 feet, by each 50 feet, and thermometer	25.00	.25
3329	Pocket Metric Aneroid, $2\frac{1}{2}$ inches diameter, altitude scale to 1,500 meters, reading to 5 meters, and pressure scale reading to $\frac{1}{2}$ millimeter	21.00	.25

ANEROID BAROMETERS

No.		PRICE	POST
3330	Pocket Metric Aneroid, 2½ inches diameter, altitude scale to 3,000 meters, reading to 10 meters, and pressure scale reading to 1 millimeter	\$22.00	\$0.25
3332	Pocket Metric Aneroid, 2½ inches diameter, altitude scale to 5,000 meters, reading to 20 meters, and pressure scale reading to 2 millimeters	24.00	.25
3336	Plain Aneroid, no altitude scale, 5 inches diameter, with thermometer and open face to show mechanism, for parlor use	16.00	
3338	Plain Aneroid, no altitude scale, 6½ inches diameter, and with one thermometer reading to scale of Fahrenheit and Reaumur, and open face to show mechanism, for parlor use	20.00	
3340	Self-recording Aneroid Barometer (Barograph) with a series of five vacuum chambers. Atmospheric pressures from 28 to 30.5 inches are registered for one week. With charts for one year and bottle of ink. In mahogany case, hinged cover with handle, and glass front	45.00	

The graduated spaces on the altitude scales of Barometers No. 3300 to 3332 can be subdivided by the eye or by using a magnifier, and thus a closer reading obtained.

A leather sling case for Barometers Nos. 3306 to 3332, and omitting the morocco case, costs extra, \$1.50

SURVEYING AND MINING ANEROIDS

BRONZED CASES, SILVERED DIALS WITH REVOLVING MAGNIFIER. COMPENSATED FOR TEMPERATURE. IN LEATHER SLING CASES

No.		PRICE	POST
3350	Surveying Aneroid, 3 inches diameter, altitude scale to 6,000 feet, by each 20 feet and by vernier to 2 feet	\$45.00	\$0.40
3352	Surveying Aneroid, 3 inches diameter, with altitude scale to 10,000 feet, by each 50 feet and by vernier to 5 feet	48.00	.40
3354	Surveying Aneroid, 3 inches diameter, with altitude scale to 16,000 feet, by each 50 feet and by vernier to 5 feet	50.00	.40
3355	Mining Aneroid, 3 inches diameter, arranged to register 2,000 feet below sea level to 4,000 feet above, by each 20 feet and by vernier to 2 feet	45.00	.40

SURVEYING AND MINING ANEROIDS



No. 3360

No.		PRICE
3360	Surveying Aneroid, 5 inches diameter, with altitude scale to 5,000 feet, by each 10 feet and by vernier to 1 foot	\$50.00
3362	Surveying Aneroid, 5 inches diameter, with altitude scale to 10,000 feet, by each 20 feet and by vernier to 2 feet	53.00
3364	Surveying Aneroid, 5 inches diameter, with altitude scale to 16,000 feet, by each 20 feet and by vernier to 2 feet	55.00
3366	Surveying Aneroid, 5 inches diameter, with altitude scale to 20,000 feet, by each 50 feet and by vernier to 5 feet	60.00

The Surveying and Mining Aneroid has been constructed especially for the use of Surveyors and Engineers, for ascertaining slight variations in gradients, levels, etc., and from its extreme sensitiveness will be found of considerable utility in Mining and Surveying Work generally.

The Vernier Scale is moved by rack and pinion, and the magnifier which rotates on the outer circumference of the instrument facilitates the reading of the vernier.

TO USE THE ANEROID, WITH ALTITUDE SCALE

Find the height in feet at first station and subtract this from the height in feet at second station. If the mean temperature is greater or less than 50° F., apply correction for temperature as hereafter given.

Example:

Aneroid at Station A, 1,800 feet. Thermometer, 50°.

Aneroid at Station B, 800 feet. Thermometer, 70°.

The approximate height is 1,000 feet. The sum of the temperatures is 120. A correction of +20 is therefore applied. This is 20 feet. The difference of elevation is therefore 1,000 + 20 = 1,020 feet.

TO FIND THE RELATIVE HEIGHT OF TWO GIVEN PLACES

Take a reading of the Aneroid at first station; subtract from this the reading at second station. The product multiplied by 9 will give the difference of altitude in feet, thus:

First Station, 30.20; Second Station, 29.99; $30.20 - 29.99 = .21$;
 $.21 \times 900$ (or $.21 \times 9$) = 189 feet = difference of altitude.

This under ordinary pressures and with a temperature about 50° F. will give good results. If the temperature is over 70° F. multiply by 10. The table prepared by Mr. Symons is more strictly accurate:

MEAN TEMPERATURE	30°	40°	50°	60°	70°	80°
Mean pressures, 27 in. . .	9.7	9.9	10.1	10.3	10.5	10.8
Mean pressures, 28 in. . .	9.3	9.5	9.8	10.0	10.2	10.4
Mean pressures, 29 in. . .	9.0	9.2	9.4	9.6	9.8	10.0
Mean pressures, 30 in. . .	8.7	8.9	9.1	9.3	9.5	9.7

Roughly speaking, the barometer falls one inch for every 900 feet of ascent; or at mean atmospheric pressure in this latitude,

Above sea level 917 feet, the barometer falls 1 inch.
 Above sea level 1,860 feet, the barometer falls 2 inches.
 Above sea level 2,830 feet, the barometer falls 3 inches.
 Above sea level 3,830 feet, the barometer falls 4 inches.
 Above sea level 4,861 feet, the barometer falls 5 inches.

ANEMOMETERS

FOR MEASURING THE PRESSURE AND VELOCITY OF CURRENTS OF AIR IN COAL MINES, AND VENTILATORS, FLUES, ETC., OF PUBLIC BUILDINGS

"Biram's." — For registering the velocity of currents of air in mines, tunnels, etc., by means of a light fan, the revolutions of which are recorded on a dial in the center of the instrument.

This instrument placed in the passage of a mine registers automatically the rate at which the air is traveling through it, and a simple observation will detect any slackening of the current arising from obstruction of the ways or want of attention at the ventilating furnace, or fan wheel.

We furnish a rating card with each Anemometer, showing the friction constant to be added in every computation, which is ascertained by us by actual experiment.



No. 3382

No.		PRICE	POST
3380	Biram's Anemometer, 3 in. diameter, reading to 1,000 feet, with disconnector, in case	\$20.00	\$0.30
3383	Biram's Anemometer, 4 in. diameter, reading to 100,000 feet, with disconnector, in case . . .	23.00	.40
3386	Biram's Anemometer, 6 in. diameter, reading to 100,000 feet, with disconnector, in case . . .	28.00	.60

ANEMOMETERS

No.		PRICE	POST
3390	Biram's Anemometer, watch pattern, hunting case, very sensitive, reading to 1,000 feet . . .	30.00	.18

Pocket size, 2 inches diameter. — Is made in the form of a watch. The top and bottom of the case, when opened, form a base for the instrument, and a check spring passing through the pendant acts as a stop to the movement, on being pressed by the finger at the expiration of the time necessary to make the observation. The movement is jeweled at four points. The outer circle of divisions on the dial records by single feet up to one hundred; the smaller dial continues the enumeration up to one thousand feet.

HOW TO USE THE ANEMOMETER

The Anemometer consists of a series of vanes, which revolve with the action of the air current, the number of revolutions, or numbers proportioned to the revolutions, being registered by a pointer on the face of a dial, forming part of the instrument itself. An observer has only to record the position of the several indices at the first observation, by writing the lower of the two figures on the respective circles, between which the index points, in their proper order, and deduct the amount from their position at the second observation, to ascertain the velocity of the air which has passed in the interval. This, multiplied by the area in feet of the passage where the instrument is placed, will show the number of cubic feet which has passed during the same period.

Thus, suppose the observation of one minute gives:

Second reading	525
First reading	225
	<u>300</u>
Add correction, say	30
	330

Size of passage in feet, $10 \times 5 \times 330 = 16,500$ feet per minute.

The correction added above is the value of the constant of friction, which must be found for each machine by actual experiment.

TO FIND THE VELOCITY OF THE AIR
IN THE PASSAGE

Proceed thus: Suppose the Anemometer indicates 330 feet per minute. $330 \div 88 = 3.75$, or $3\frac{3}{4}$ miles per hour, 88 being $\frac{1}{60}$ th of a mile.

To ascertain the force of the air current, multiply the square of the velocity of the air in feet per second by .0023.

AIR METERS



No. 3395

No.		PRICE	POST
3395	Portable Air Meter, with fan wheel $2\frac{3}{4}$ in. diameter, four dials recording to 100,000 feet, and disconnector. The pointers can be set to zero at will by a setting attachment and key . . .	\$25.00	\$0.35
3397	Portable Air Meter, with fan wheel $2\frac{3}{4}$ inches diameter, six dials recording to 10,000,000 feet, and disconnector, but without zero setting attachment	25.00	.35

The Portable Air Meter is for the measurement of currents of air through mines, tunnels, sewers and the ventilators of hospitals, public buildings, etc. The indications are obtained by means of a delicately poised fan wheel, the recordings being commenced by the long hand, which traverses the extreme outer circumference of the main dial for the passage of one hundred feet of air. The enumeration is continued by a series of smaller dials as shown in the illustration. A Disconnector, projecting from the band of the instrument, opposite the fan wheel, serves to throw the mechanism out of gear, and arrest its action, when required. The instrument is packed, with universal jointed socket holder, in a box about four inches square.

FIELD GLASSES

The Field Glasses here described are of the best quality and especially adapted for tourists, engineers, military service, or general field use. They are achromatic, and are metal body covered with morocco, and have a case with strap. Some are designated by the diameter of the objectives, in French lines, eleven lines being equal to one inch.

BARDOU & SON FIELD GLASS. HIGH TOPS

No.		PRICE	Post
3432	Field Glass; objectives, 24 lines	\$18.00	\$0.45
3433	Field Glass, U. S. Signal Service; objectives, 26 lines.	20.00	.50



No. 3437

LEMAIRE FIELD GLASS. Low TOPS

No.		PRICE	Post
3436	Field Glass; objectives, 21 lines	\$18.00	\$0.35
3437	Field Glass; objectives, 24 lines	15.00	.40
3439	Field Glass; objectives, 26 lines	17.00	.45

FIELD GLASSES

COLMONT FIELD GLASS. Low Tops

No.		PRICE	Post
3440	Field Glass; objectives, 24 lines	\$12.00	\$0.40
3441	Field Glass; objectives, 26 lines	13.00	.45
3444	Field Glass, jointed cross bars, for pupillary distance; objectives, 21 lines	14.50	.35

RANCHMAN'S FIELD GLASS. HIGH TOPS

No.		PRICE	Post
3445	Field Glass; objectives, 26 lines	\$18.00	\$0.50

LEMAIRE FIELD GLASS. HIGH TOPS

No.		PRICE	Post
3448	Field Glass; objectives, 24 lines	\$15.00	\$0.45
3449	Field Glass; objectives, 26 lines	17.00	.50

COLMONT FIELD GLASS. HIGH TOPS

No.		PRICE	Post
3450	Field Glass; objectives, 24 lines	\$12.00	\$0.45
3451	Field Glass; objectives, 26 lines	13.00	.50

BUSCH JENA FIELD GLASS. Low Tops

No.		PRICE	Post
3453	Field Glass; objectives, 24 lines	\$16.00	\$0.40
3454	Field Glass; objectives, 26 lines	18.00	.45
3455	Field Glass, jointed cross bars, for pupillary distance; objectives, 21 lines	18.00	.35
3456	Field Glass, jointed cross bars, for pupillary distance; objectives, 24 lines	19.50	.40

PRISM BINOCULARS

The Prism Binocular, in design and construction, is simple, compact, of light weight and elegant finish. It combines large field of view with great magnifying power and clear definition. One eyepiece cap is graduated and can be adjusted for normal, near sighted and far sighted eyes. The metal body is covered with fine black morocco and each Binocular has a beautiful leather case with strap.



No. 3459

BUSCH STEREO ULTRALUX

No.		Magnifying Power	Field of View at 1000 yds.	PRICE	Post
3458	Prism Binocular, No. 50	6	125	\$50.00	\$0.40
3459	Prism Binocular, No. 60	8	87	50.00	.45

BUSCH STEREO SULLOX

A SUPERIOR GLASS FOR LONG RANGE STALKING, ETC.

No.		Magnifying Power	Field of View at 1000 yds.	PRICE	Post
3461	Prism Binocular, No. 55	6	125	\$60.00	\$0.40
3462	Prism Binocular, No. 66	8	87	65.00	.45

PRISM BINOCULARS



No. 3464

BUSCH LYNKOP PATTERN

No.		Magnifying Power	Field of View at 1000 yds.	PRICE	Post
3464	Prism Binocular, No. 2	6	125	\$40.00	\$0.40
3465	Prism Binocular, No. 3	9	80	40.00	.45
3466	Prism Binocular, No. 4	12	60	40.00	.80

MAGAPHOSE FRENCH PATTERN

No.		Magnifying Power	Field of View at 1000 yds.	PRICE	Post
3468	Prism Binocular, No. 18548	8	87	\$25.00	\$0.45

NOTE. Prism Binoculars, of any other standard make, supplied at Catalogue Prices.

ACHROMATIC TELESCOPES

MOROCCO COVERED BODY AND BURNISHED DRAW TUBES

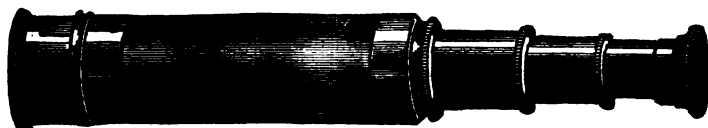

No. 3475

No.		PRICE	POST
3475	Telescope, with 3 draws, 17 $\frac{1}{4}$ inches drawn out, 6 $\frac{1}{2}$ inches shut, objective 1 $\frac{1}{8}$ inches in diameter, power 12 times	\$2.50	\$0.20
3476	Telescope, with 3 draws, 18 $\frac{3}{4}$ inches drawn out, 7 inches shut, objective 1 $\frac{1}{4}$ inches in diameter, power 16 times	3.50	.25
3477	Telescope, with 3 draws, 23 $\frac{3}{4}$ inches drawn out 8 $\frac{1}{2}$ inches shut, objective 1 $\frac{1}{2}$ inches in diameter, power 20 times	5.00	.30
3478	Telescope, with 3 draws, 31 inches drawn out, 10 $\frac{3}{4}$ inches shut, objective 1 $\frac{5}{8}$ inches in diameter, power 25 times	7.00	.40
3479	Telescope, with 4 draws, 37 inches drawn out, 11 inches shut, objective 2 inches in diameter, power 30 times	10.00	.65
3480	Telescope, with 4 draws, 42 inches drawn out, 12 $\frac{1}{2}$ inches shut, objective 2 $\frac{1}{8}$ inches in diameter, power 40 times	17.00	
3481	Telescope, with 4 draws, 48 inches drawn out, 13 $\frac{1}{2}$ inches shut, objective 2 $\frac{3}{8}$ inches in diameter, power 50 times	30.00	

TOURISTS ACHROMATIC TELESCOPES

No.		PRICE	POST
3485	Telescope, with oxidized draw tubes and brass body covered with morocco; 3 draws, 17 inches drawn out, 6 inches shut; objective 1 $\frac{1}{4}$ inches in diameter; sun shade; leather caps to cover eyepiece and objective, and shoulder strap. Power 20 times	\$8:00	\$0.20
3486	Telescope, same as No. 3485, but is 21 inches drawn out, 7 inches shut; objective 1 $\frac{5}{8}$ inches diameter. Power 25 times	11.00	.30
3487	Telescope, same as No. 3485, but is 24 inches drawn out, 9 inches shut; objective 1 $\frac{3}{4}$ inches diameter. Power 30 times	13.00	.40

TOURISTS ACHROMATIC TELESCOPES



No.	No. 3488	Price	Post
3488	Telescope, same as No. 3485, but has 4 draws, 36 inches drawn out, 10 inches shut; objective 2 inches in diameter. Power 35 times .	\$22.00	\$0.60
3492	Rifle Spy Glass, 10 $\frac{3}{4}$ inches drawn out; body covered with morocco; objective $\frac{1}{2}$ inch in diameter. Power 10 times .	2.50	.17
3494	Wooden Tripod, with vertical and horizontal motion, upon which to place a telescope. A useful article, as a telescope of much power cannot be held in the hand with sufficient steadiness	5.00	
3495	Wooden Tripod, similar to No. 3494, but with more rigid legs and arranged to raise and lower the telescope	7.50	
3496	Improved Nickel Plated Clamp with Gimlet Screw to fasten telescope to a post or tree. Adjustable to fit telescopes from $\frac{3}{4}$ to 2 inches diameter	2.50	.15



No. 3496

ASTRONOMICAL TELESCOPES

No.		PRICE
3502	Astronomical Telescope, polished brass body, 35 inches long, mounted on brass tripod stand, achromatic objective $2\frac{3}{4}$ inches in diameter, one terrestrial eyepiece, power 50 times, one celestial eyepiece, power 100 times, rack and pinion for focusing. In box with lock	\$75.00
3506	Astronomical Telescope, polished brass body, 35 inches long, rack and pinion for focusing, achromatic objective $2\frac{1}{2}$ inches in diameter, terrestrial eyepiece, power 40 times, celestial eyepiece with darkener, power 80 times, wooden tripod with horizontal and vertical motion. In box with lock, for receiving the body and eyepieces	75.00

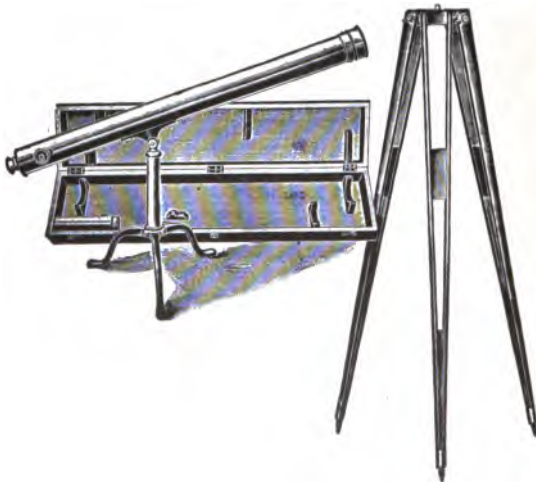

No. 3503

3508	Astronomical Telescope. Same as No. 3506 but with body 40 inches long, achromatic objective 3 inches in diameter, terrestrial eyepiece, power 55 times, celestial eyepiece with darkener, power 110 times. In box with lock	100.00
------	---	--------

POCKET MAGNIFIERS



No. 3520



No. 3526

RUBBER CASE, OVAL FORM, 1 DOUBLE CONVEX LENS

No.		PRICE	POST	No.		PRICE	POST
3520	1 inch . .	\$0.35	\$0.02	3522	1½ inch . .	\$0.55	\$0.03
3521	1¼ inch . .	.45	.02	3523	2 inch85	.04

RUBBER CASE, OVAL FORM, 2 DOUBLE CONVEX LENSES

3526	⅞ and 1 in.	.60	.03	3528	1¼ and 1½ inch	1.00	.14
------	-------------	-----	-----	------	---------------------------	------	-----

RUBBER CASE, BELLOWS FORM, 1 DOUBLE CONVEX LENS

3530	¾ inch35	.02	3532	1 inch45	.02
------	--------------	-----	-----	------	--------------	-----	-----

RUBBER CASE, BELLOWS FORM, 2 DOUBLE CONVEX LENSES

3534	⅝ and ¾ inch.	.50	.03	3536	⅞ and 1 inch	.65	.03
------	---------------	-----	-----	------	--------------	-----	-----

RUBBER CASE, BELLOWS FORM, 3 DOUBLE CONVEX LENSES

3538	½, ⅝ and ¾ in.	.70	.04	3539	¾, ⅞ and 1 in.	.95	.40
3542	White Celluloid Case, oval form, one ¾ inch double convex lens80	.02
3543	White Celluloid Case, oval form, one 1¼ inch double convex lens					1.00	.12
3550	German Silver Case, oval form, one 1 inch double convex lens75	.04

POCKET MAGNIFIERS



No. 3555



No. 3560

No.		PRICE	POST
3555	Microscope, brass mounted, on three legs, adjustable	\$0.55	\$0.05
3560	Linen Prover, for counting threads in linen fabrics, brass mounted, $\frac{1}{4}$ inch square open space	.50	.02
3561	Linen Prover, for counting threads in linen fabrics, brass mounted, $\frac{1}{100}$ inch round open space	.50	.02
3562	Linen Prover, for counting thread in linen fabrics, brass mounted, $\frac{1}{100}$ inch round and $\frac{1}{4}$ inch square open spaces	.60	.02
3565	Linen Prover, for counting threads in linen fabrics, brass mounted, 1 inch square open space	2.00	.15



No. 3566

3566	Coddington Lens, brass mounted, small	1.00	.14
3567	Coddington Lens, brass mounted, medium	1.25	.14
3568	Coddington Lens, brass mounted, large	1.50	.15
3569	Aplanatic Magnifier, high power, and flat field	1.00	.14

POCKET MAGNIFIERS



No. 3570

No.		PRICE	POST
3570	Coddington Lens, nickeled frame and cover, $\frac{1}{2}$ inch diameter	\$1.25	\$0.14
3571	Coddington Lens, nickeled frame and cover, $\frac{3}{4}$ inch diameter	1.50	.14
3572	Coddington Lens, nickeled frame and cover, 1 inch diameter	1.75	.15
3575	Aplanatic Triplet, nickeled frame and cover, superior quality, giving perfect definition and flat field, $\frac{1}{2}$ inch focus, power 20 times	5.00	.14
3577	Aplanatic Triplet, nickeled frame and cover, superior quality, giving perfect definition and flat field, 1 inch focus, power 10 times	5.00	14

Lenses Nos. 3566 to 3577 have extra power and definition for examining minerals, ore, rock, flowers, etc.

READING AND PICTURE GLASSES

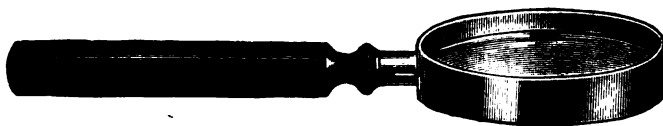

No. 3585

READING GLASS, METAL FRAME, DOUBLE CONVEX LENS

No.		PRICE	Post	No.		PRICE	Post
3585	2 in. diam.	\$.75	\$.05	3589	4 in. diam.	\$2.35	\$.19
3586	2½ in. diam.	.95	.06	3591	5 in. diam.	3.75	.35
3587	3 in. diam.	1.30	.17	3593	6 in. diam.	5.00	.40

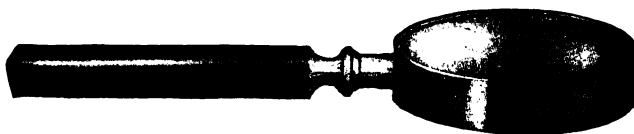

No. 3595

READING GLASS, METAL FRAME, TWO PLANO CONVEX LENSES

3595	2 in. diam.	1.20	.16	3597	3 in. diam.	2.00	.20
3596	2½ in. diam.	1.60	.17	3598	3½ in. diam.	2.80	.22

READING GLASS, OBLONG METAL FRAME, DOUBLE CONVEX LENS

3600	2¾ x 1½ in.	1.35	.15	3602	3¼ x 1½ in.	1.80	.18
3601	3 x 1½ in.	1.60	.17	3603	3½ x 1¾ in.	2.25	.20

ADJUSTABLE POCKET LEVELS

Plain vials mounted in nickel plated tubes on japanned bases. Bases have a longitudinal groove for use in leveling, shafting, cylindrical work, etc.

No.		PRICE	No.		PRICE
3650	4 inches	\$1.00	3652	8 inches	\$1.50
3651	6 inches	1.25	3653	12 inches	2.00

POCKET SPIRIT LEVELS

A superior article. Our own make, with ground and graduated vial, mounted in brass and adjustable, and in wood case.



No. 3660

No.		PRICE	Post	No.		PRICE	Post
3660	6 inches	\$3.50	\$0.18	3664	10 inches	\$4.50	\$0.25

LEVEL VIALS, UNMOUNTED

OUR OWN MAKE, AND EVERY ONE TESTED

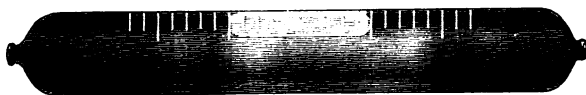

No. 3675

3675	Ground and graduated level vials, unmounted:*					
	1½ in.	\$0.45	2 in.	\$0.50	2½ in.	\$0.60
	3 in.75	3½ in.90	4 in.	1.05
	4½ in.	1.20	5 in.	1.45	5½ in.	1.65
	6 in.	1.80	6½ in.	2.00	7 in.	2.25
3690	Ground level vials, not graduated, unmounted:*					
	1 to 1½ in.35	2 in.40	2½ in.50
	3 in.60	3½ in.75	4 in.90
	4½ in.	1.00	5 in.	1.25	5½ in.	1.40
	6 in.	1.50	6½ in.	1.65	7 in.	1.85

We cannot furnish vials smaller than ¼ in. in diameter. If sent by mail, the postage on unmounted level vials, 1½ to 7 inches, will be 3 cents to 18 cents, according to size.

* When ordering, mention the extreme length and diameter required.

CARPENTERS AND MASONS SPIRIT LEVELS

No.		PRICE
3726	Cherry Body, 26 in. long, with level and plumb vials	\$0.75
3730	Cherry Body, 26 in. long, brass ends, both vials adjustable	1.25
3734	"Handy" Plumb and Level, cherry body, 26 in. long, brass ends, adjustable vials	1.50
3740	Iron Frame, 22 in. long, adjustable vials. The plumb vial is set in a graduated brass circle and can be used as a slope level	3.50

OILSTONES

No.		PRICE	POST
3765	Arkansas Oilstone, fine quality, about $2\frac{1}{2} \times \frac{3}{4}$ inch, for drawing pens, pen knives and needle points	.25	.03
3767	Arkansas Oilstone, fine quality, $3\frac{1}{2}$ inch, in vulcanized rubber case	1.00	.16

TRAMMEL POINTS



No. 3730

No.		PRICE	POST
3780	Trammel Points, small, No. 1	\$1.00	\$0.15
3781	Trammel Points, medium, No. 2	1.25	.18
3782	Trammel Points, large, No. 3	1.65	.20
3800	Machinists Tools, Lathe and Drill Chucks and Drills, Steel Squares and Gauges, Brass Tubing and Wire, Sheet Brass and German Silver, Stubs Steel Wire, etc., etc., at manufacturers prices.		

STEEL MAGNETS

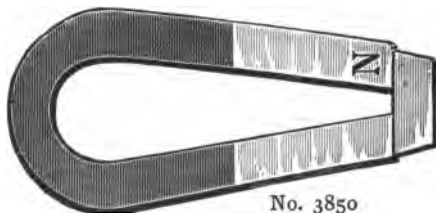

No. 3850

No.		PRICE	POST	No.		PRICE	POST
3850	2 inches . . .	\$0.12	\$0.03	3856	5 inches . . .	\$0.50	\$0.10
3852	3 inches20	.04	3858	6 inches75	.13
3854	4 inches35	.06	3860	7 inches . . .	1.10	.20

BRASS BLOW PIPES

PLAIN				WITH BULB			
No.		PRICE	Post	No.		PRICE	Post
3865	8 inches . .	\$0.15	\$0.05	3875	8 inches .	\$0.30	\$0.05
3867	10 inches . .	.20	.06	3877	10 inches .	.35	.06
3869	12 inches . .	.25	.07	3879	12 inches .	.40	.07

THERMOMETERS

JAPANNED TIN CASE, "OPEN AIR" RANGE

LIGHT TIN CASE				HEAVY TIN CASE			
No.		PRICE	Post	No.		PRICE	Post
3890	6 in., Mercury	\$0.45	\$0.06	3900	7 in., Mercury	\$0.65	\$0.10
3892	8 in., Mercury	.50	.08	3901	8 in., Mercury	.75	.15
3894	10 in., Mercury	.65	.10	3903	10 in., Mercury	1.00	.20

HEAVY JAPANNED TIN CASE, "WATERBOIL" RANGE

3910	8 in., Mercury	\$0.85	\$0.10	3912	10 in., Mercury	\$1.10	\$0.20
------	----------------	--------	--------	------	-----------------	--------	--------

COPPER CASE, "OPEN AIR" RANGE

3914	6 in., Mercury	\$0.65	\$0.08	3916	8 in., Mercury	\$0.75	\$0.10
------	----------------	--------	--------	------	----------------	--------	--------

POLISHED WOOD BACK, "OPEN AIR" RANGE

OAK, WALNUT, MAHOGANY, CHERRY, OR SATINWOOD

3918	6 in., Mercury	\$1.00	\$0.18	3922	10 in., Mercury	\$1.50	\$0.22
3920	8 in., Mercury	1.25	.20	3924	12 in., Mercury	2.00	.25

PORTABLE OR POCKET CASE, "OPEN AIR" RANGE

POLISHED MAHOGANY OR OAK CASE WITH REVERSIBLE COVER

3935	4 in., Mercury	\$1.70	\$0.14	3936	6 in., Mercury	\$2.00	\$0.16
3938	Pocket Thermometer, in 5 inch nickel plated metal tube					\$0.85	\$0.06
3940	Window Thermometer, 8 inch, plate glass, with brackets, 30° below zero					1.25	.25
3941	Window Thermometer, same as No. 3940, but 50° below zero					1.50	.25
3950	Chemical Thermometer, all glass, 14 inch, to 300° F.					2.00	.25
3952	Chemical Thermometer, all glass, 14 inch, to 400° F.					2.25	.25
3954	Chemical Thermometer, all glass, 14 inch, to 500° F.					2.50	.25

SELF REGISTERING THERMOMETERS

No.		PRICE	POST
3960	Maximum Thermometer, 10 inch, wood back	\$2.75	\$0.20
3962	Maximum Thermometer, U. S. Weather Bureau pattern, 12 inch, aluminum scale	5.00	.20
3965	Minimum Thermometer, 10 inch, wood back	2.25	.20
3967	Minimum Thermometer, U. S. Weather Bureau pattern, 12 inch, aluminum scale	4.25	.20



No. 3970

3970	U. S. Weather Bureau set of Maximum and Minimum Thermometers, same as Nos. 3962 and 3967, and mounted together on one wood back	9.50	.50
------	---	------	-----

HYGROMETERS

No.		PRICE	POST
3975	Masons Hygrometer, consisting of dry and wet bulb thermometers mounted on one wood back	\$2.25	\$0.25
3976	Masons Hygrometer, consisting of dry and wet bulb thermometers mounted on a polished boxwood back with beveled edges. Lines are drawn on the scales for convenience in obtaining a humidity of 50° at the normal temperature of the living room	4.50	.30

All of these Thermometers, Nos. 3960 to 3976, have the Fahrenheit scale, and are of fine quality.

RAIN GAGES

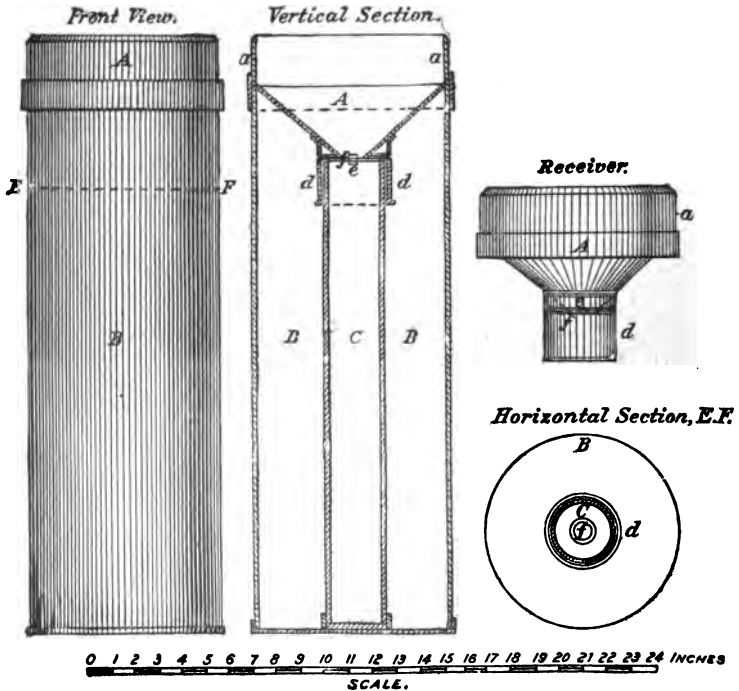

No. 3981

No.

3981

U. S. Weather Bureau Standard Rain and Snow Gage of galvanized iron, 8 inches diameter, 25½ inches high, with measuring stick. The receiver has a capacity for 2 inches of rainfall, and in connection with the overflow the possible capacity is 20 inches of rainfall. The gage is so adjusted that the reading is magnified 10 times and 1 inch of rainfall actually measures 10 inches on the stick

PRICE

\$6.00

RAIN GAGES



No. 3982

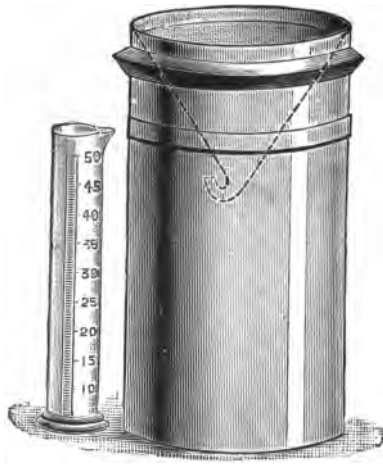

No. 3983

No.		PRICE
3982	Howards Rain Gage, consisting of a vertical glass bottle, through the neck of which the terminal tube of a galvanized iron funnel, 5 inches in diameter, is inserted. A glass graduate, measuring to 100ths of an inch, is furnished with the instrument	\$4.00
3983	Glaishers Rain Gage, consisting of a galvanized iron cylinder, with a receiving funnel 8 inches in diameter terminating in a curved tube which prevents evaporation. A glass graduate, measuring to 100ths of an inch, is furnished with the instrument	7.00
3984	Smithsonian Rain Gage, of capacity for 1 inch rainfall. This gage is made of brass and is the most simple in its construction of any now in use. It has a measuring stick which reads to 10ths and 100ths of inches; also a wooden cylinder to insert in the ground for the protection and ready adjustment of the instrument	5.00

MINERS LAMP**No. 3987****MINERS SAFETY LAMPS****No. 3988 C.****No. 3988 D.**

MINERS LAMP

No.		PRICE	POST
3987	Miners Copper Lamp, with hook, size No. 2 . . .	\$0.30	\$0.10

MINERS SAFETY LAMPS

No.		PRICE
3988C	Miners Brass Safety Lamp (Clanny)	\$3.00
3988D	Miners Brass Safety Lamp (Davy)	2.50

For Anemometers and Air Meters for Miners use, see pages 485 to 487

HYDROMETERS

WITH BAUME'S SCALE

No.		PRICE	POST
3990	Hydrometers, for testing Acid, Alkalies, Ammonia, Bark, Beer, Ether, Milk, Molasses, Oils, Salt Water, Spirits, Syrup, Urine, Vinegar. Each	\$0.75	\$0.10
3995	Twaddell's Hydrometers, Nos. 1 to 6, with scales respectively 0 to 24, 24 to 48, 48 to 72, 72 to 100, 100 to 134, 134 to 180, each graduation representing five degrees of specific gravity. Each75	.10



SCIENTIFIC BOOKS

SCIENTIFIC BOOKS

FOR SALE BY

W. & L. E. GURLEY

TROY, NEW YORK - U. S. A.

Architecture, Carpentry and Building, Astronomy, Bridges, Roofs and Tunnels, Chemistry and Physics, Construction, Strength of Materials, Drawing, Electricity and Telegraphy, Geology, Mining and Metallurgy, Hydraulic and Sanitary Engineering, Machinery and Mechanics, Pocket Table Books, Surveying and Engineering, Instruments, Etc.

When ordering, either send drafts on New York, or postal orders on Troy, N. Y.; or if money is enclosed in letters, such letters should be registered at the post office where mailed.

We prepay postage on nearly all American and English books when the price is sent to us in advance.

Books can be registered at an extra cost of ten cents for each package of not over four pounds.

Orders for over \$10 will be sent by express C. O. D. if desired; but for smaller sums please remit the necessary amount with the order.

Write all letters legibly, give your Post Office, County and State, and be sure to sign your letter before mailing.

We are not responsible for loss of goods sent by mail.

Should any other works on kindred topics be desired, we will furnish them at publishers prices.

ARCHITECTURE, CARPENTRY AND BUILDING

	PRICE
BIRKMIRE, W. H. The Planning and Construction of High Office Buildings. 8vo. 361 pages. Illustrated	\$3.50
BULLOCK, J. Rudiments of Architecture and Building. 8vo. 468 pages. 250 illustrations	2.50
BYRNE, A. T. Inspection of the Materials and Workmanship Employed in Construction. 16mo. 625 pages	3.00
CARPENTER, R. C. The Heating and Ventilating of Buildings. 8vo. 578 pages. 277 illustrations	4.00
FREITAG, J. K. Architectural Engineering and High Building Construction. 8vo. 421 pages. 196 illustrations	3.50
HATFIELD, R. G. Theory of Transverse Strains in the Construction of Buildings, Iron Girders, Roofed Trusses, etc. 8vo.	5.00
HURST, J. T. Hand Book for Architectural Surveyors	2.00
KEMP-WAUGH. Landscape Gardening. 12mo. 314 pages. Illustrated	1.50
KETCHUM, M. S. Design of Steel Mill Buildings and Calculation of Stresses in Frame Structures. 8vo. 480 pages. Illustrated	4.00
KIDDER, F. E. Architects and Builders Pocket Book. 16mo. 1722 pages. Illustrated	5.00
KIDDER, F. E. Building Construction and Superintendence. Part I. Masons Work. 8vo. 421 pages. 254 illustrations	4.00
KIDDER, F. E. Building Construction and Superintendence. Part II. Carpenters Work. 8vo. 551 pages. 537 illustrations	4.00

ASTRONOMY

AMERICAN EPHEMERIS AND NAUTICAL ALMANAC. 8vo. Each year	\$1.50
BOWDITCH, N. American Practical Navigator. An Epitome of Navigation and Nautical Astronomy. 8vo. 652 pages	3.00
CHAUVENET, WM. Manual of Spherical and Practical Astronomy. 2 vols. Royal 8vo.	6.00
COMSTOCK, G. C. Textbook of Field Astronomy for Engineers. 230 pages. 8vo.	2.50
DOOLITTLE, C. L. Treatise on Fractical Astronomy. 8vo. 652 pages	4.00
HAYFORD, J. F. Textbook of Geodetic Astronomy. 8vo. 360 pages	3.00

	PRICE
NAUTICAL ALMANAC. Published by authority of the Secretary of the Navy, Washington. Each year	\$0.75
PROCTOR, R. A. Half Hours with the Stars. A plain and easy guide to the knowledge of the constellations, with explanation of each map. Demy 4to.	2.00
YOUNG, C. A. Manual of Astronomy. 8vo. 618 pages	2.25
YOUNG, C. A. Textbook of General Astronomy. 8vo. 630 pages	2.75

BRIDGES, ROOFS, ETC.

BENDER, C. B. Principles of Economy in the Design of Metallic Bridges, including Cantilever Bridges. 195 pages. 12 plates	\$2.50
BURR-FALK. Design and Construction of Metallic Bridges. 8vo. 545 pages. Illustrated	5.00
BURR-FALK. Graphic Method by Influence Lines for Bridge and Roof Computations. 8vo. 286 pages	3.00
DU BOIS, A. J. The Mechanics of Engineering. Vol. II. Small 4to. 632 pages. Illustrated	10.00
FOSTER, W. C. Wooden Trestle Bridges. The present practice on American railroads. 4to. 271 pages. 164 illustrations. 47 plates	5.00
GREENE, C. E. Roof Trusses. 8vo. 97 pages. Illustrated	1.25
GREENE, C. E. Bridge Trusses. 8vo. 190 pages. Illustrated	2.50
GREENE, C. E. Arches in Wood, Iron and Stone. 8vo. 194 pages. Illustrated	2.50
HÄUPT, H. Military Bridges, Trestle and Truss Bridges. 8vo.	6.50
HOWE, M. A. Design of Simple Roof Trusses in Wood and Steel. 8vo. 167 pages	2.00
HOWE, M. A. Treatise on Arches. 8vo. 392 pages. Illustrated	4.00
JACOBY, H. S. Structural Details or Elements of Design in Heavy Framing. 8vo. 377 pages. Illustrated	2.25
JOHNSON-BRYAN-TURNEAURE. Theory and Practice in the Designing of Modern Framed Structures. 4to. 572 pages	10.00
JOHNSON-BRYAN-TURNEAURE. The Theory and Practice of Modern Framed Structures. In three parts.	
Part 1. Stresses in Simple Structures. 8vo. 338 pages. Illustrated	3.00
Part 2. Statically Indeterminate Structures and Secondary Stresses. 8vo. 554 pages. Illustrated	4.00

	PRICE
KETCHUM, M. S. Design of Highway Bridges. 8vo. 564 pages. Illustrated	\$4.00
MERRIMAN-JACOBY. Textbook on Roofs and Bridges.	
Part 1. Stresses in Simple Trusses. 8vo. 326 pages	2.50
Part 2. Graphic Statics. 8vo. 242 pages	2.50
Part 3. Bridge Design. 8vo. 382 pages	2.50
Part 4. Higher Structures. 8vo. 385 pages	2.50
SHREVE, S. H. Strength of Bridges and Roofs. With practical applications and examples. 89 illustrations. 8vo.	3.50
SKINNER, F. W. Types and Details of Bridge Construction. 8vo. Illustrated	
Vol. I. Arch Spans. 301 pages	3.00
Vol. II. Plate Girders. 424 pages	4.00
Vol. III. Specifications and Standards for Short Railroad Spans. 307 pages	3.00
WADDELL, J. A. L. De Pontibus; a Pocket Book for Bridge Engineers. 16mo. 418 pages	2.00
WHIPPLE, S. Bridge Building. Practical Treatise on Iron and Wooden Bridges. 8vo. 358 pages. Illustrated	3.00

CEMENT, CONCRETE AND REINFORCED CONCRETE

BUEL-HILL. Reinforced Concrete. 8vo. 511 pages. Illustrated	\$5.00
GILLETTE-HILL. Concrete Construction, Methods and Cost. 8vo. 700 pages. Illustrated	5.00
SABIN, L. C. Cement and Concrete. 6x9 in. 584 pages. Illustrated	5.00
REID, H. A. Concrete and Reinforced Concrete Construction. 8vo. 902 pages. Illustrated	5.00
SPALDING, F. P. Hydraulic Cement. 12mo. 308 pages. Illustrated	2.00
TAYLOR, W. P. Practical Cement Testing. 8vo. 330 pages. Illustrated	3.00
TAYLOR-THOMPSON. Treatise on Concrete, Plain and Reinforced. 8vo. 848 pages. Illustrated	5.00
TRAUTWINE-TRAUTWINE. Concrete, Plain and Reinforced. 16mo. 200 pages. Illustrated	2.00
TURNEAURE-MAURER. Principles of Reinforced Concrete Construction. 8vo. 439 pages. Illustrated	3.50

CHEMISTRY, PHYSICS, ETC.

	Pages	
ATTFIELD, J. Chemistry, General, Medical and Pharmaceutical. 12mo.		\$2.75
CHURCH, A. H. The Laboratory Guide; Practical Chemistry for Colleges and Schools, and Agricultural Students. 12mo.		2.50
CLASSEN-BOLTWOOD. Quantitative Chemical Analysis by Electrolysis. 8vo. 315 pages. Illustrated		3.00
FRESENIUS-WELLS. Qualitative Chemical Analysis. Revised edition. 8vo. 765 pages		5.00
FRESENIUS-COHN. Quantitative Chemical Analysis. 2 vols. 2076 pages. Illustrated		12.50
Vol. I (Separately)		6.00
Vol. II (Separately)		8.00
GANOT-ATKINSON. Elementary Treatise on Physics, experimental and applied. 8vo. 1057 illustrations		5.00
KAHLENBERG, L. Outlines of Chemistry. 8vo. 567 pages. Illustrated		2.60
McPHERSON-HENDERSON. An Elementary Study of Chemistry. 12mo. 445 pages. Illustrated		1.50
PRESCOTT, A. B. First book in Quantitative Chemistry. 12mo.		1.50
PRESCOTT-JOHNSON. Qualitative Chemical Analysis (Inorganic). 8vo.		3.50
REED-GUTHE. College Physics. 8vo. 651 pages. Illustrated		3.50
REMSEN, I. Organic Chemistry. 12mo. 441 pages. Illustrated		1.50

CIVIL ENGINEERING AND MECHANICS

CHURCH, I. P. Mechanics of Engineering. 8vo. 890 pages. Illustrated		\$6.00
LANZA, G. Applied Mechanics. 8vo. 936 pages. Illustrated		7.50
PATTON, W. M. A Treatise on Civil Engineering. 8vo. 1672 pages. Illustrated		7.50
RANKINE-MILLAR. A Manual of Applied Mechanics. Crown 8vo. 690 pages. Illustrated		5.00
RANKINE-MILLAR. A Manual of Civil Engineering. Crown 8vo. 838 pages. Illustrated		6.50

CONTRACTS AND SPECIFICATIONS

JOHNSON, J. B. Engineering Contracts and Specifications. 8vo. 581 pages		\$3.00
WADDELL-WAIT. Specifications and Contracts, with notes on the Law of Contracts. 8vo. 174 pages		1.00
WAIT, J. C. The Law of Contracts. 8vo. 345 pages		3.00

SPECIFICATIONS.

	PRICE
Steel Railroad Bridges and Structures. By A. W. Buel . . .	\$0.50
Steel Highway Bridges. By Theodore Cooper50
Steel Railroad Bridges. By Theodore Cooper50
Railway Bridge Superstructure. By The Osborn Co.25
Highway Bridge Superstructure. By The Osborn Co.25
Railway Bridges. By E. Thacher25
Highway Bridges. By E. Thacher25
Steel Bridges. By J. A. L. Waddell50
Foundations and Substructures of Highway and Electric Railway Bridges. By Theodore Cooper	1.00
Stone and Brick Passenger Stations. By C. Dillenbeck40
Frame Passenger Stations. By C. Dillenbeck40
Stone and Brick Freight Houses. By C. Dillenbeck40
Frame Freight Houses. By C. Dillenbeck40
Steel Frame Mill Buildings. By M. S. Ketchum25
Steel Roofs and Buildings. By C. E. Fowler25
Concrete Work as Applied to Building Construction. By W. J. Watson50
Concrete Bridges. By W. J. Watson	1.00
Cast Iron Pipe and Special Castings. By N. E. Waterworks Association10
Track Laying. By W. Katte10
Cross-ties. By W. Katte05
Street Roadway Pavements. By S. Whinery50

DRAWING AND LETTERING

ANTHONY, G. C. Mechanical Drawing. 98 pages. 32 plates	\$1.75
ANTHONY, G. C. Machine Drawing. 56 pages. 18 plates	1.75
BROWN, G. E. Ferric and Heliographic Processes. Illus- trated	1.00
CHURCH, A. E. Elements of Descriptive Geometry; Spheri- cal Projections, Shades and Shadows, Perspective and Iso- metric Projections. 8vo., and Atlas of Plates. 12mo. 4to.	3.50
COOLIDGE-FREEMAN. Elements of General Drafting for Mechanical Engineers. 8vo. Oblong. 55 pages. 21 plates	2.50
CROMWELL, J. H. System of Easy Lettering. 8¼ x 5¾ in. 33 plates50
EDMINSTER, C. F. Architectural Drawing. 12mo. Ob- long. 231 pages. 105 plates	2.00
ESSER, H. Draughtsman's Alphabets. Oblong. 11 x 7 in. 31 plates	1.50
JACOBY, H. S. Text Book on Plain Lettering. 8vo. Oblong. 89 pages. 48 plates	3.00

	Price
MAHAN-THOMPSON. Industrial Drawing; 1 vol., 222 pages, and Atlas of Plates. 8vo.	\$3.50
MAXTON, J. Manual of Engineering Drawing. 12mo.	1.40
MINIFIE, WM. Mechanical Drawing, including an Introduction to Isometrical Drawing, and an Essay on Linear Perspective and Shadows. 200 illustrations. 8vo.	4.00
REED, H. A. Topographical Drawing and Sketching, and Photography applied to Surveying. 226 pages. Illustrated, and with 26 plates. 4to.	5.00
REID, J. S. Mechanical Drawing, Elementary and Advanced. 8vo. 320 pages. Illustrated.	2.00
REINHARDT, C. W. Lettering for Draftsmen, Engineers and Students. 8x11 in. 34 pages. 11 plates	1.00
REINHARDT, C. W. Technic of Mechanical Drafting. 8x11 in. 42 pages. Illustrated. 11 plates	1.00
SMITH-McMILLAN. Manual of Topographic Drawing. 8vo. 123 pages. 14 plates	2.50
STANLEY, W. F. Mathematical Drawing Instruments; with hints upon Drawing and Coloring. 12mo.	2.00
TUTHILL, W. B. Practical Lessons in Architectural Drawing. 11½x7½ in. 61 pages, with 33 plates.	2.50
WARREN, S. E. General Problems of Shades and Shadows. 8vo.	3.00
WARREN, S. E. Manual of Linear Perspective. 12mo.	1.00
WARREN, S. E. Elements of Descriptive Geometry. 8vo. 300 pages, and Atlas of Plates	3.50
WILSON, V. T. Freehand Lettering. 8vo. 105 pages. Illustrated	1.00

EARTHWORK, ROCKWORK, TUNNELING

CRANDALL, C. L. Railway and Other Earthwork Tables. 8vo. 45 pages	\$1.50
CROCKETT, C. W. Methods for Earthwork Computations. 8vo. 124 pages. Illustrated	1.50
GILLETTE, H. P. Earthwork and Its Cost. 12mo. 254 pages. Illustrated	2.00
GILLETTE, H. P. Rock Excavation. Methods and Cost. 12mo. 384 pages. Illustrated	3.00
HENDERSON, R. S. Earthwork Tables. 32 pages	1.00
HOWARD, C. R. Earthwork Mensuration on the Basis of the Prismoidal Formula. 8vo. Illustrated	1.50
HUDSON, J. R. Tables for Calculating the Cubic Contents of Excavations and Embankments. 8vo. 131 pages	1.00
PRELINI, C. Earth and Rock Excavation. 8vo. 363 pages. Illustrated	3.00

	PRICE
PRELINI-HILL. Tunneling. 8vo. 316 pages. Illustrated	\$3.00
STAUFFER, D. McN. Modern Tunnel Practice. 8vo. 314 pages. Illustrated	3.50
TRAUTWINE, J. C. Method of Calculating the Cubic Contents of Excavations and Embankments by the Aid of Diagrams. 8vo. 71 pages	2.00

ELECTRICITY, TELEGRAPHY, ETC.

ARRHENIUS, S. A Text Book of Electro-Chemistry. 8vo. 355 pages. Illustrated	\$3.50
BELL, LOUIS. Electric Power Transmission. A Practical Treatise. 8vo. 727 pages. Illustrated	4.00
CROCKER, F. B. Electric Lighting; A Practical Treatise for Electricians and Students. 2 vols. 8vo. Illustrated	6.00
CROCKER-WHEELER. The Management of Electrical Machinery. 16mo. 230 pages. Illustrated	1.00
CROCKER-ARENDT. Electric Motors; Their Action, Control and Application. 8vo. 296 pages. Illustrated	2.50
CUSHING, H. C., Jr. Standard Wiring for Electric Light and Power. 16mo. 157 pages	1.00
DAWSON, PHILIP. The "Engineering" and Electrical Traction Pocket Book. 16mo. 1073 pages. Illustrated	5.00
FERGUSON, O. J. The Elements of Electrical Transmission. 8vo. 464 pages. Illustrated	5.00
FOSTER, H. A. Electrical Engineer's Pocket Book. 16mo. 1636 pages. Thumb index. Fully illustrated	5.00
HERRICK, A. B. Practical Electric Railway Hand Book. 12mo. 460 pages. Illustrated	3.00
HOMANS, J. E. A B C of the Telephone. A Practical Treatise. 8vo. 352 pages. 269 illustrations	1.00
HOUSTON-KENNELLY. Electric Street Railways. 373 pages. 162 illustrations	1.00
LOCKWOOD, T. D. Electricity, Magnetism, and Electric Telegraphy. General Information for Electrical Students, Operators, and Inspectors. 8vo. 378 pages. 152 illustrations	2.50
PERRINE, F. A. C. Conductors for Electrical Distribution. 8vo. 300 pages. Illustrated	3.50
POPE, F. L. Modern Practice of Electric Telegraph. 8vo. Illustrated	1.50
SLOANE, T. O'C. Standard Electrical Dictionary. 682 pages. 12mo. Illustrated	3.00
STANDARD HANDBOOK for Electrical Engineers. By a Staff of Specialists. 16mo. 1300 pages. Illustrated	4.00
WEINGREEN, J. Electric Power Plant Engineering. 420 pages. Illustrated	5.00

FORESTRY

	PRICE
CARY, A. A Manual for Northern Woodsmen. 16mo. 262 pages. Illustrated	\$2.06
GRAVES, H. S. Forest Mensuration. 8vo. 472 pages. Illustrated	4.00
GRAVES, H. S. The Principles of Handling Woodlands. Large 12mo. 346 pages. Illustrated	1.50
GREEN, S. B. Principles of American Forestry. 12mo. 347 pages. Illustrated	1.50

GEOLOGY, MINING AND METALLURGY

BAUERMAN, H. Metallurgy of Iron. Outlines of the History of Iron Manufacture, Analysis of Iron Ores, etc. 12mo.	\$2.00
BEARD, J. T. Mine Gases and Explosions. 12mo. 419 pages. Illustrated	3.00
BETTS, A. G. Lead Refining by Electrolysis. 8vo. 403 pages. Illustrated	4.00
BOWIE, A. J., Jr. Practical Treatise on Hydraulic Mining, with Description of the Use and Construction of Ditches, Flumes, Wrought Iron Pipes, and Dams; Flow of Water on Heavy Grades, and its Applicability, under High Pressure, to Mining. 313 pages. 8vo. Illustrated	5.00
BROUGH, B. H. Treatise on Mine Surveying. 8vo. 388 pages. Illustrated	2.50
CAMPBELL, H. H. Manufacture and Properties of Iron and Steel. 8vo. 641 pages. Illustrated	5.00
COAL AND METAL MINERS POCKET BOOK. 12mo. 637 pages. Illustrated	3.00
DANA, E. S. Minerals and How to Study Them. 12mo. 386 pages. Illustrated	1.50
DANA, E. S. Textbook of Mineralogy. 8vo. 600 pages. Illustrated	4.00
DANA, J. D. Manual of Geology, treating especially of American Geological History. 8vo. 1088 pages. Illustrated	6.00
DANA, J. D. Manual of Mineralogy and Petrography. 12mo. 517 pages. Illustrated	2.00
DANA-RICE. Textbook of Geology. 12mo	2.50
EISSLER, M. The Modern High Explosives. 8vo. 406 pages. Illustrated	4.00
FURMAN-PARDOE. Manual of Practical Assaying. 8vo. 538 pages. Illustrated	3.00
IHLENG-WILSON. Manual of Mining. 8vo. 741 pages. Illustrated	5.00
LeCONTE-FAIRCHILD. Elements of Geology. 679 pages. Illustrated	4.00

	PRICE
OSBORN, H. S. Prospectors Field Book and Guide. 12mo. 379 pages. Illustrated	\$1.50
RICKETTS-MILLER. Notes on Assaying. 8vo. 319 pages. Illustrated	3.00
SCHNABEL-LOUIS. Handbook of Metallurgy.	
Vol. I. Copper, Lead, Silver, Gold	6.50
Vol. II. Tin, Zinc, Nickel, etc. (not Iron)	6.50
VAN WAGENEN, T. F. Manual of Hydraulic Mining, for the use of the Practical Miner. 18mo.	1.00
WILSON, E. B. Cyanide Processes. 12mo. 256 pages. Illustrated	1.50
WILSON, E. B. The Chlorination Process. 12mo. 130 pages	1.50
WILSON, E. B. Practical and Theoretical Mine Ventilation. 12mo. 148 pages. Illustrated	1.25
WILSON, E. B. Hydraulic and Placer Mining. 12mo. 361 pages. Illustrated	2.50

HYDRAULIC AND SANITARY ENGINEERING

ADAMS, J. W. Sewers and Drains for Populous Districts. Rules and Formulas for the Dimensions and Construction of Works of Sanitary Engineers. 8vo. 228 pages. Illustrated	\$2.50
BEARDSLEY, R. C. Design and Construction of Hydroelectric Plants. 8vo. 520 pages. Illustrated	5.00
BILLINGS, W. R. Details of Waterworks Construction. 8vo. 96 pages. Illustrated	2.00
BURR, W. H. Ancient and Modern Engineering and the Isthmian Canal. 8vo. 488 pages. Illustrated	3.50
COFFIN, F. C. Graphical Solution of Hydraulic Problems. 16mo. 85 pages. 36 diagrams	2.50
DUNBAR-CALVERT. Principles of Sewage Treatment. 8vo. 294 pages. Illustrated	6.00
EKIN, T. C. Water Pipe and Sewer Discharge Diagrams. 9 x 14 in. 21 pages. 4 diagrams	3.00
ELLIOTT, C. G. Engineering for Land Drainage. 12mo. 240 pages. Illustrated	1.50
ELLIOTT, C. G. Practical Farm Drainage. 12mo. 197 pages. Illustrated	1.50
FANNING, J. T. Hydraulic and Water Supply Engineering. 8vo. 644 pages. Illustrated	5.00
FOLWELL, A. P. Water Supply Engineering. 8vo. 590 pages. Illustrated	4.00
FOLWELL, A. P. Sewerage; Designing, Construction, and Maintenance of Sewerage Systems. 8vo. 516 pages. Illustrated	3.00

	PRICE
FRENCH'S Principles, Process and Effects of Draining Lands. Over 100 illustrations. 12mo.	\$1.50
FRIZELL, J. P. Water Power; Development and Application of the Energy of Flowing Water. 8vo. 653 pages. Illustrated	5.00
GANGUILLET-KUTTER-HERING-TRAUTWINE. A General Formula for the Uniform Flow of Water in Rivers and Other Channels. 8vo. 264 pages. Illustrated	4.00
GERHARD, W. P. Sanitation of Public Buildings. 12mo. 273 pages	1.50
GOODRICH, W. F. Economic Disposal of Town's Refuse. 8vo. 340 pages. Illustrated	3.50
HAZEN, ALLEN. Filtration of Public Water Supply. 8vo. 333 pages. Illustrated	3.00
HAZLEHURST, J. N. Towers and Tanks for Waterworks. 8vo. 335 pages. Illustrated	2.50
HILL, J. W. Purification of Public Water Supplies. 8vo. 304 pages. Illustrated	3.00
HISS-ZINSSER. A Text-book of Bacteriology. 8vo. 759 pages. Illustrated.	6.00
HOYT-GROVER. River Discharge. 8vo. 145 pages. Illustrated	2.00
HUGHES-SAFFORD. A Treatise on Hydraulics. 8vo. 519 pages. Illustrated.	5.00
MASON, W. P. Water Supply. 8vo. 455 pages. Illustrated.	4.00
MEAD, D. W. Water Power Engineering. 8vo. 803 pages. Illustrated	6.00
MERRIMAN, M. Treatise on Hydraulics, Hydrostatics, Hydraulic Motors, etc. 8vo. 593 pages. Illustrated	5.00
NEWELL, F. H. Irrigation in the United States. 12mo. 452 pages. Illustrated	2.00
OGDEN, H. N. Sewer Design. 12mo. 245 pages. Illustrated	2.00
OGDEN, H. N. Sewer Construction. 8vo. 347 pages. Illustrated	3.00
PRESCOTT-WINSLOW. Elements of Water Bacteriology. 12mo. 270 pages. Illustrated	1.50
RAFTER-BAKER. Sewage Disposal in the United States. 625 pages. Illustrations and plates. 8vo.	6.00
RAIKES, H. P. Sewage Disposal Works. 8vo. 429 pages. Illustrated	4.00
STALEY-PIERSON. The Separate System of Sewerage. Theory and Construction. Illustrated. 8vo. 280 pages. 21 tables	3.00
STEWART, H. Irrigation for the Farm, Garden, and Orchard. Illustrated. 276 pages. 12mo.	1.50
THOMAS-WATT. The Improvement of Rivers. 4to. 370 pages. Illustrated	6.00

	PRICE
TURNEAURE-RUSSELL. Public Water Supplies. Requirements and Constructions. 8vo. 823 pages. Illustrated	\$5.00
WARING, G. E. Draining for Profit and Health. How to Lay Out and Construct a System of Drains. Illustrated. 12mo	1.50
WARING, G. E. Modern Methods of Sewage Disposal. 260 pages. Illustrated. 12mo.	2.00
WARING, G. E. Sanitary Drainage of Houses and Towns. 12mo.	2.00
WARING, G. E. Sewerage and Land Draining. 406 pages and 30 plates. 4to.	6.00
WILLIAMS-HAZEN. Hydraulic Tables. Showing loss of Head due to Friction of Water flowing in Pipes, Aqueducts, Sewers, etc., and Discharge over Weirs. 8vo. 75 pages. Illustrated	1.50
WILSON, H. M. Irrigation Engineering. Hydrography. Canals and Canal Works. Storage Reservoirs. 8vo. 655 pages. Illustrated	4.00

MASONRY, FOUNDATIONS, DAMS, ARCHES

BAKER, I. O. Treatise on Masonry Construction. 8vo. 760 pages. Illustrated	\$5.00
CORTHELL, E. L. Allowable Pressure on Deep Foundations. 12mo. 98 pages	1.25
FOWLER, C. E. Ordinary Foundations. 8vo. 367 pages. Illustrated	3.50
HOWE, M. A. Retaining Walls for Earth. 12mo. 179 pages. Illustrated	1.25
HOWE, M. A. Symmetrical Masonry Arches. 8vo. 180 pages. Illustrated	2.50
PATTON, W. M. Practical Treatise on Foundations. 8vo. 577 pages. Illustrated	5.00
SCHUYLER, J. D. Reservoirs. Large 8vo. 599 pages. Illustrated	6.00
WEGMANN, E. Design and Construction of Dams. 4to. 545 pages. Illustrated	6.00

MECHANICAL ENGINEERING

APPLETON'S Dictionary of Mechanics. 5,000 engravings. Large 8vo. 2 vols., sheep binding	\$15.00
BOURNE, JOHN. A Catechism of the Steam Engine. 12mo	2.00
BOURNE, JOHN. Handbook of the Steam Engine. A key to the "Catechism of the Steam Engine." Illustrated. 12mo	1.75
BROWN & SHARPE MFG. CO. Gear Wheels and Gearing. Practical Treatise, with Tables. Illustrated. 8vo.	1.00

	PRICE
CLARK, D. K. A Manual of Rules, Tables, and Data for Mechanical Engineers, based on the most recent investigations. Illustrated with numerous Diagrams. Large 8vo. 1012 pages	\$5.00
COOPER, J. H. Use of Belting for Transmission of Power. 8vo. Illustrated	3.50
FITZGERALD, W. S. The Boston Machinist. Illustrated	1.00
FORNEY, M. N. Catechism of the Locomotive. 709 pages. 500 illustrations. 8vo.	3.50
GOODEVE, T. M. Textbook on the Steam Engine. 12mo. 148 illustrations	2.00
HASWELL, C. H. Mechanics and Engineers Pocket Book. 16mo. 1098 pages. Illustrated	4.00
HEMENWAY, F. F. Indicator Practice and Steam Engine Economy. 12mo. 184 pages. Illustrated	2.00
HUGHES, WM. C. American Miller and Millwright's Assistant. 12mo.	1.50
KENT, W. Mechanical Engineers Pocket Book. 16mo. 1501 pages. Illustrated	5.00
PRAY, THOS., Jr. Twenty Years with the Indicator. 286 pages. 175 illustrations. 8vo.	2.50
ROPER, S. Handbook of Land and Marine Engines, including their Modeling, Construction, and Management. 12mo	3.50
ROPER, S. Handbook of the Locomotive; Construction and Management of Locomotive Engines and Boilers. 12mo.	2.50
SCHUMANN, F. A. Manual of Heating and Ventilation. Embracing a Series of Tables and Formulæ for dimensions of heating, flow and return pipes for steam and hot water boilers, flues, etc. 12mo. Illustrated	1.50
SUPLEE, H. H. Mechanical Engineers Reference Book. 12mo. 867 pages. Illustrated	5.00
THURSTON, R. H. Manual of Steam Boilers; Design, Construction and Operation. 8vo. 889 pages. 244 illustrations	5.00
THURSTON, R. H. A Manual of the Steam Engine. 2 vols. 8vo. 1000 pages. Illustrated	10.00
Part 1. History, Structure, and Theory	6.00
Part 2. Design, Construction, and Operation.	6.00

MUNICIPAL IMPROVEMENTS

GOODHUE, W. F. Municipal Improvements. 12mo. 215 pages. Illustrated	\$1.50
McCULLOUGH, E. Engineering Work in Towns and Cities. 12mo. 510 pages. Illustrated	3.00
WHINERY, S. Municipal Public Works. 8vo. 255 pages	1.75

PAVEMENTS AND ROADS

	PRICE
BAKER, I. O. Treatise on Roads and Pavements. 8vo. 663 pages. Illustrated	\$5.00
BYRNE, A. T. Highway Construction. 8vo. 1083 pages. Illustrated	5.00
JUDSON, W. P. City Roads and Pavements. 8vo. 197 pages. Illustrated	2.00
RICHARDSON, C. Modern Asphalt Pavement. 8vo. 638 pages. Illustrated	3.00
SPALDING, F. P. Textbook on Roads and Pavements. 12mo. 350 pages. Illustrated	2.00

POCKET BOOKS FOR CIVIL ENGINEERS

ALLEN, C. F. Field and Office Tables. 16mo. 296 pages	\$2.00
ALLEN, C. F. Railroad Curves and Earthwork. 16mo. 225 pages.	2.00
BURT, W. A. Key to the Solar Compass, and Surveyors Companion. All the rules necessary for use in the field; Linear Surveys and Public Land System of the United States. Notes on the Barometer, suggestions for an outfit for a survey of four months, etc. 16mo. 202 pages	2.50
BUTTS, EDWARD. Civil Engineers Field Book; designed for the Locating Engineer. Numerous tables. 16mo. 275 pages	2.50
CLARK, J. M. Railway Turnouts. 16mo. 38 pages. Illustrated	1.00
CLEVINGER, S. V. Government Surveying. 16mo. 200 pages. Illustrated	2.50
COX, WM. The Stadia Computer75
CRANDALL-BARNES. Field Book for Railroad Surveying. 16mo. 202 pages. Illustrated	2.00
CRANDALL, C. L. The Transition Curve. 16mo. 105 pages. Illustrated	1.50
DORR, B. F. The Surveyors Guide. 16mo. 149 pages. Illustrated	2.00
GILLETTE, H. P. Handbook of Cost Data. 16mo. 1878 pages. Illustrated	5.00
GODWIN, H. C. Railroad Engineers Field Book and Explorers Guide. 16mo. 370 pages. Illustrated	2.50
HAMILTON, W. G. Useful Information for Railway Men. 562 pages	2.00
HENCK, J. B. Field Book for Railroad Engineers. 16mo. 328 pages. Illustrated	2.50
HODGMAN, F. Surveyors Tables; being the 21 tables as printed in Hodgmans Manual of Surveying. 16mo. 106 pages	1.00

	PRICE
KELLOGG, N. B. The Transition Curve. 16mo. 75 pages. Illustrated	\$1.75
MERRIMAN-BROOKS. Handbook for Surveyors. Land Surveying, Leveling, Triangulation, Topography, Tables. 16mo. 246 pages	2.00
MERRIMAN, M. The American Civil Engineers Pocket-book. 16mo. 1888 pages. Illustrated	5.00
NAGLE, J. C. Field Manual for Railroad Engineers. 16mo. 418 pages. Illustrated	3.00
PENCE-KETCHUM. A Manual of Field and Office Methods. 16mo. 266 pages. Illustrated	2.00
PHILBRICK, P. H. Field Manual for Engineers. 16mo. 403 pages. Illustrated	3.00
RAYMOND, W. G. Railroad Field Geometry. 16 mo. 255 pages. Illustrated. (No Tables)	2.00
SEARLES, WM. H. Field Engineering. Railway Surveying, Location, and Construction. 16mo. 519 pages. Illustrated	3.00
SEARLES, WM. H. The Railroad Spiral. 16mo. 137 pages. Illustrated	1.50
SHUNK, W. F. The Field Engineer; the Survey, Location and Track Work of Railroads. 16mo. 355 pages. Illustrated	2.50
SHUNK, W. F. Railway Curves and Location. 16mo. 106 pages. Illustrated	2.00
STILES, A. Tables for Field Engineers. 16mo. 156 pages. Illustrated	2.00
TAYLOR, T. U. Surveyors Handbook. 328 pages. Illustrated	2.00
TRAUTWINE, J. C. Field Practice of Laying out Circular Curves for Railroads. 12mo. 192 pages	2.50
TRAUTWINE, J. C. Civil Engineers Pocket Book. 1300 pages. Illustrated. Morocco.	5.00
WATERBURY, L. A. Vest Pocket Handbook of Mathematics for Engineers. 97 pages. 61 illustrations	1.00

RAILWAY CONSTRUCTION, ECONOMICS AND MAINTENANCE

ANDREWS, H. B. Handbook for Street Railway Engineers. 3 x 5 in. 202 pages. Illustrated	\$1.25
BEAHAN, W. The Field Practice of Railway Location. 8vo. 260 pages. Illustrated	3.00
BROOKS, J. P. Handbook of Street Railroad Location. 16mo. 145 pages. Illustrated	1.50
LAVIS, F. Railroad Location, Surveys and Estimates. 8vo. 277 pages. Illustrated	3.00
MOLITOR-BEARD. Manual for Resident Engineers. 16mo. 122 pages. Illustrated	1.00

	PRICE
RAYMOND, W. G. Elements of Railroad Engineering. 8vo. 421 pages. Illustrated	\$3.50
THE ROADMASTERS ASSISTANT. 12mo. 298 pages. Illustrated	1.50
TRATMAN, E. E. R. Railway Track and Track Work. 8vo. 539 pages. Illustrated	3.50
WEBB, W. L. Economics of Railroad Construction. 12mo. 347 pages. Illustrated	2.50
WEBB, W. L. Railroad Construction. Theory and Practice. 16mo. 794 pages. Illustrated	5.00
WELLINGTON, A. M. Economic Theory of the Location of Railways. 8vo. 1002 pages. Illustrated	5.00

STRENGTH OF MATERIALS

BURR, WM. H. Elasticity and Resistance of the Materials of Engineering. 1089 pages. 8vo. Illustrated	\$7.50
JOHNSON, J. B. Materials of Construction. 8vo. 810 pages. Illustrated	6.00
MERRIMAN, M. Mechanics of Materials. 8vo. 518 pages. Illustrated	5.00
SHIELDS, J. E. Notes on Engineering Construction, and description of the materials employed in Tunneling, Bridg- ing, Canal and Road Building, etc. Illustrated. 12mo.	1.50

SURVEYING AND GEODESY

BREED-HOSMER. Principles and Practice of Surveying. Vol. 1. Elementary Surveying. 8vo. 571 pages. Illustrated	\$3.00
Vol. 2. Higher Surveying. 8vo. 449 pages. Illustrated	2.50
CRANDALL, C. L. Textbook on Geodesy and Least Squares. 8vo. 339 pages. Illustrated	3.00
DAVIES-VAN AMRINGE. Elements of Surveying and Leveling; Topography, Railway Curves, and Mining Sur- veying. 12mo.	2.50
GILLESPIE-STALEY. Gillespies Surveying. Part I. Land Surveying and Direct Leveling. 8vo. 555 pages. Illustrated	2.50
GILLESPIE-STALEY. Gillespies Surveying. Part II. Higher Surveying. 8vo. 467 pages. Illustrated	2.50
HAUPT, L. M. The Topographer; his Instruments and Methods. Fully illustrated. 8vo. 247 pages. 7 plates	3.00
HODGMAN, F. Manual of Land Surveying. 12mo. 555 pages. Illustrated	2.50
JEFFERS, W. N. Treatise on Nautical Surveying. 8vo. Illustrated	5.00

	PRICE
JOHNSON-SMITH. The Theory and Practice of Surveying. 8vo. 953 pages. Illustrated.	\$3.50
LOGAN, G. W. Elements of Hydrographic Surveying. 12mo. 176 pages. Illustrated	1.75
MERRIMAN, M. Elements of Precise Surveying and Geodesy. 8vo. 261 pages. Illustrated	2.50
NUGENT, P. C. Plane Surveying, Text and Reference Book for Students and Engineers. 8vo. 634 pages. Illustrated	3.50
PHELPS, LIEUT. H. Practical Marine Surveying. 8vo. 217 pages. Illustrated	2.50
RAYMOND, W. G. Textbook of Plane Surveying. 8vo. 495 pages. Illustrated	3.50
ROBINSON'S Surveying and Navigation. With use of instruments, essential Elements of Trigonometry, Mensuration, and the necessary tables. Edited by Oren Root, A. M. 8vo.	2.25
ROOT, CAPT. E. A. Military Topography and Sketching. 8vo. 395 pages. 219 illustrations. New Edition, enlarged	2.75
SIMMS, F. W. Treatise on Leveling. With Law's method of laying out Curves. 8vo. 215 pages	2.50
TRACY, J. C. Plane Surveying. A Textbook and Pocket Manual. 16mo. 811 pages. Illustrated	3.00
WEBB, W. L. Problems in the Use and Adjustment of Engineering Instruments. 16mo. 168 pages. Illustrated	1.25
WILSON, H. M. Topographic Surveying, including Geographic, Exploratory, and Military, Mapping, Camping, Photography, etc. 8vo. 940 pages. Illustrated	3.50

SURVEYING AND MATHEMATICAL TABLES

BARLOW-DeMORGAN. Barlows Tables. 12mo. 207 pages	\$2.50
BOILEAU, J. T. Complete Set of Traverse Tables. 8vo. 140 pages	5.00
BREMIKER-ALBRECHT. Logarithmisch-Trigonometrische Tafeln (six decimal places). 8vo. 616 pages	1.80
BRUHNS, C. A new manual of Logarithms (seven decimal places). 8vo. 634 pages	2.50
CRELLE-SEELIGER. Rechentafeln. 10 x 15 in. 506 pages	5.00
CROCKETT, C. W. Logarithmic and Trigonometric Tables to five decimal places. 8vo. 118 pages	1.25
DAVIS, A. P. Elevation and Stadia Tables. 8vo. 43 pages	1.00
GURDEN, R. L. Traverse Tables, 9 x 14 in. 270 pages	7.50
VEGA-FISCHER. Logarithmic Tables (seven decimal places). 8vo. 603 pages	2.50

TREATISES ON INSTRUMENTS, ETC.

	PRICE
BAKER, I. O. Engineers Surveying Instruments. 12mo. 400 pages. 86 illustrations	\$3.00
COX, WM. Manual of the Polar Planimeter25
COX, WM. Slide Rule Manual50
CROCKETT, C. W. Explanation of Mannheim Slide Rule75
GURLEY, W. & L. E. Manual of the Principal Instruments used in American Engineering and Surveying. Latest Edition, revised. 532 pages. Fully illustrated50
HALSEY, F. A. Manual of the Slide Rule50
HOARE, C. The Slide Rule, and How to Use It. With a Slide Rule in tuck of cover	1.00
MANUAL of the Duplex and Mannheim Slide Rules75
STANLEY, W. F. Surveying and Leveling Instruments. Fully described. 12mo. 552 pages. 345 illustrations	3.00
WHEATLEY, J. Y. Polar Planimeter. Its use in Engineer- ing Calculations. 8vo. 126 pages. Illustrated	3.00

MISCELLANEOUS

ALEXANDER, J. H. Weights and Measures. Ancient and Modern, reduced to Standard of the United States. 8vo	\$3.50
CHAUVENET, W. Plane and Spherical Trigonometry. 8vo	1.60
CHAUVENET, W. Treatise on Elementary Geometry. 8vo	1.75
CROCKETT, C. W. Elements of Plane and Spherical Trig- onometry, with Tables	1.50
GURLEY, W. & L. E. Handbook of Weights and Measures, for the use of Sealers. 190 pages. Illustrated50
GURLEY, W. & L. E. Physical and Scientific Instruments. 260 pages. Illustrated50
LIPPINCOTT'S Pronouncing Gazetteer of the World. 4to, sheep	12.00
ROBINSON'S Geometry and Trigonometry. 8vo.	2.25
WEBSTER'S Unabridged Dictionary. 4to, sheep	12.00

SCIENCE SERIES

18MO. FANCY BOARDS, 50 CENTS EACH

- 1 Chimneys for Furnaces and Steam Boilers. By R. Armstrong, C. E.
- 4 Proportions of Pins Used in Bridges. By Chas. E. Bender, C. E.
- 5 Ventilation of Buildings. By W. G. Snow.
- 6 Designing and Construction of Storage Reservoirs. By A. Jacob, A. B.
- 11 Theory of Arches. By Prof. W. Allan.
- 12 Theory of Voussoir Arches. By Prof. W. E. Cain.
- 13 Gases Met with in Coal Mines. By J. J. Atkinson.
- 14 Friction of Air in Mines. By J. J. Atkinson.
- 15 Skew Arches. By Prof. E. W. Hyde, C. E.
- 18 Sewerage and Sewage Purification. By M. N. Baker, Ph. B.
- 19 Strength of Beams under Transverse Loads. By Prof. W. Allan.
- 20 Bridge and Tunnel Centers. By John B. McMaster, C. E.
- 22 High Masonry Dams. By E. S. Gould, C. E.
- 23 Fatigue of Metals under repeated Strains. From the German of Prof. Spangenburg, with a Preface by S. H. Shreve, A. M.
- 25 Theory and Calculation of Cantilever Bridges. By R. M. Wilcox.
- 26 Practical Treatise on Properties of Continuous Bridges. By Charles Bender, C. E.
- 31 Sanitary Condition of Dwelling Houses. By Geo. E. Waring, Jr.
- 32 Cable Making for Suspension Bridges. By Hildenbrand, C. E.
- 33 Mechanics of Ventilation. By Geo. W. Rafter, C. E.
- 34 Foundations. By Prof. Jules Gaudard, C. E.
- 35 Aneroid Barometer: Its Construction and Use. By Geo. W. Plympton.
- 38 Maximum Stresses in Framed Bridges. By Prof. W. Cain, A. M., C. E.
- 41 Strength of Materials. By Wm. Kent, C. E.
- 42 Theory of Steel Concrete Arches and of Vaulted Structures. By Prof. W. Cain, C. E.
- 44 Turbine Wheels. By Prof. W. P. Trowbridge.
- 48 Theory of Solid and Braced Elastic Arches. By W. Cain, C. E.
- 50 Dwelling Houses; their Sanitary Construction and Arrangements. By Prof. W. H. Corfield.
- 55 Sewer Gases; their Nature and Origin. By A. de Varona.
- 58 Ventilation of Coal Mines. By W. Fairley, M. E.
- 59 Railroad Economics. By S. W. Robinson, C. E.

- 60 Strength of Wrought Iron Bridge Members. By S. W. Robinson, C. E.
- 61 Potable Water: and Methods of Detecting Impurities. By M. N. Baker.
- 63 House Drainage and Sanitary Plumbing. By W. P. Gerhard, C. E.
- 65 Pocket Logarithms to Four Places of Decimals.
- 67 Hydraulic Tables. By P. J. Flynn, C. E.
- 72 Topographical Surveying. By Geo. J. Specht, Prof. A. S. Hardy, John B. McMaster, and H. F. Walling.
- 74 Testing Machines, their History, Construction and Use. By Arthur V. Abbott.
- 77 Stadia Surveying and Stadia Measurements. By A. Winslow.
- 80 Healthy Foundations for Houses. By Glenn Brown.
- 81 Water Meters: Comparative Tests of Accuracy, Delivery, etc. By Ross E. Browne.
- 82 Preservation of Timber by the Use of Antiseptics. By S. B. Boulton, C. E.
- 83 Mechanical Integrators. By Prof. Henry S. H. Shaw, C. E.
- 84 Flow of Water in Open Channels, Pipes, Conduits, Sewers, etc.; with Tables. By P. J. Flynn, C. E.
- 87 Treatise on the Theory of the Construction of Helicoidal Oblique Arches. By John L. Culley, C. E.
- 91 Leveling; Barometric, Trigonometric, and Spirit. By Prof. I. O. Baker.
- 93 Notes Embodying Recent Practice in the Sanitary Drainage of Buildings. By Wm. Paul Gerhard, C. E.
- 94 Treatment of Sewage. By Dr. C. Meymott Tidy.
- 95 Plate Girder Construction. By Isami Hiroi, C. E.
- 100 How to Become an Engineer. By G. W. Plympton, C. E.
- 104 Van Nostrand's Table Book for Civil and Mechanical Engineers. Compiled by Prof. Geo. W. Plympton.
- 107 Graphical Method for Swing Bridges. By B. F. LaRue, C. E.
- 110 Transition Curves. By W. G. Fox, C. E.
- 114 Use of the Slide Rule. By F. A. Halsey.
- 115 Traverse Table, for distances between 1 and 100, and for every quarter degree up to 90 degrees.

Any of the Science Series not mentioned in the above list will be furnished promptly on application.

THE RENSSELAER
POLYTECHNIC INSTITUTE
TROY, N. Y.

A School of Engineering and Science
Founded in 1824

Three courses in Engineering and one in General Science are given at the Institute. The Engineering courses lead to the degrees Civil Engineer (C. E.), Mechanical Engineer (M. E.), and Electrical Engineer (E. E.). The General Science course leads to the degree, Bachelor of Science (B. S.). Besides these courses, all of which are four years in duration, many special courses not leading to degrees are given. These vary in length from two years to a few weeks. Such courses are given in Chemistry, Mineralogy, Geology, Assaying, Metallurgy, Water Analysis, Drawing, Surveying, Shop Work, and various courses in applied engineering subjects, including the use of the Electrical, Mechanical and Materials Testing Laboratories. Most of the practical courses in surveying are given in the summer vacation; one, three weeks in duration, in Topographical and Hydrographical Surveying, and one, three weeks in duration, in Railroad Location. Two courses in Shop Work are also given in the summer vacation; one in June and July, and another in August and September. These are each one month in length. They include Joinery, Pattern Making, Machine Shop Work, Forging and Foundry Work.

A recent gift of \$1,000,000 from Mrs. Russell Sage has enabled the Institute to build a laboratory for Mechanical and Electrical Engineering unsurpassed by that of any other school of Engineering. The building and equipment cost \$415,000. Many kinds of dynamos, motors and other forms of electrical machinery are found in the Electrical Labora-

tory, and the Mechanical Laboratory contains many kinds of steam engines, steam turbines, air compressors, gas and oil engines, as well as pumps, turbines, and other forms of water wheels.

The Materials Testing Laboratory has one machine for crushing capable of exerting a pressure of 1,200,000 pounds, and one 600,000 pound machine which will take a column 24 feet in length and a beam 22 feet long. The Laboratory also contains various other machines varying in capacity from 300,000 pounds to 50,000 pounds.

The Cement Testing Laboratory is one of the most complete to be found, and the equipment also contains machines for testing brick and other road materials.

There are two terms in the scholastic year and the tuition is \$100 a term. Other expenses are largely in control of individual students. Board and lodging varies from \$5.00 to \$9.00 per week.

Catalogues and other pamphlets issued by the Institute and sent upon application, give detailed information regarding the buildings, courses of instruction, methods of instruction, requirements for admission, and expenses.

The Appendix to the annual Catalogue contains the current addresses and occupations of all living graduates of the Institute. This forms the best index to the character of instruction given. The graduates are at present at work in 46 of the States and Territories of the Union and 19 foreign countries.

For Catalogue, write to the Director of the Rensselaer Polytechnic Institute, Troy, N. Y.

ROADS	MINERALOGY
RAILROADS	METALLURGY
BRIDGES	ASSAYING
WATERWORKS	ROOFS
SEWERS	ARCHES
CANALS	TUNNELS
BOILERS	FOUNDATIONS
STEAM ENGINES	RIVERS
STEAM TURBINES	SHIPS
GAS ENGINES	HEATING
ELECTRIC	REFRIGERATION
MACHINERY	SHOP MANAGEMENT
ELECTRIC	TELEPHONES
TRANSMISSION	ELECTRO-CHEMISTRY
DYNAMOS	CHEMICAL ANALYSIS
ELECTRIC LIGHTING	

TABLE OF CONTENTS

	PAGE
Abney Level and Clinometer	284, 285, 340
Acoustic Current Meters	261, 263, 274, 275, 338
Adjusting Bar	321
Adjusting or Striding Level	126, 321
Adjustment of Architects Level	215, 216
Drainage Level	220
Engineers Y Level	205-210
Line of Collimation	38-40, 170, 206, 207
Objective Slide	41, 42, 205
Solar Attachment	124-127
Solar Compass	137, 138, 174
Surveyors Compass	165, 166, 174, 177
Telescopic Sight	169-171
Transits	37-42, 80-85
Air Meters	485-487
Alidades for Plane Tables	251-255, 334-337
Alt Azimuth	467
Altener Drawing Instruments	355-361
Aluminum Instruments and Accessories	82, 193, 194, 299, 300, 320, 325
Anemometers	485-487
Aneroid Barometers	480-484
Angle Mirrors	473
Architects Levels	212-217, 326
Army Sketching Cases	256-258, 337
Artificial Horizons	473
Astronomical Telescopes	494
Terms	128-183
Attachments and Extras for Compasses	168, 182, 185, 322, 324
Levels	199
Transits	45, 47, 53, 67, 79-127, 319-321
Ball Spindle	151, 162, 163, 306, 322
Barograph	482
Barometers, Aneroid	480-484
Bath Trays	437
Batson Sketching Case	259, 260, 337
Battery for Current Meters	271, 338
Beaman Stadia Arc	87, 88, 320, 334
Binocular Hand Level	282, 283, 340
Blowpipes	502, 532
Blue Print Paper, Print Frames and Bath Trays	434-437
Books, Blank for Field Notes	445, 446
Scientific, for Architects, Draftsmen, Engineers and Surveyors	510-529
Boxes and Cases for Instruments	306, 307, 309, 328, 329
Drawing Instruments	361

	PAGE
Boyden Hook Gage	280-282, 339
Branch Factory 71
Bridge Tapes	291, 344
Bristol Board	481
Bronze Finish	299
Brunton Pocket Transit	467
Brushes for Water Colors	459
Builders Transit	72, 73, 319
Burt Solar Compass	134-140, 321
Calculating Instruments	407
Cases for Instruments	51, 54, 229, 306, 307, 309, 323, 329
Center Pin	159
Chains	286-289, 341, 342
Metric and Vara	289, 293, 342
Chain Tapes	290-292, 343-345
Chestermans Steel Tapes	349
Clamp and Tangent	27, 34, 84-86, 168, 320, 322, 324, 466-470
Clinometers	187, 188, 284, 285, 324, 325, 340, 446, 448, 478, 479
Collimation, Adjustment of Line of	38-40, 170, 206, 207
Color Saucers	431
Colors, Winsor & Newtons	454, 456, 457
Compass Attachments for Levels	199, 219, 326
Compasses, Attachments and Extras for	168, 182, 185, 322, 324
Clinometer	187, 188, 324, 325
Dial	191-194, 325
Geologists	186, 187, 324
Miners Dip Needle	189-191, 324, 325
Plain	161-164, 184, 185, 322, 324
Pocket	172-194, 322-325, 463-470
Prismatic	468-470
Railroad	141-146, 175-179, 321, 323
Solar	134-140, 172-177, 321, 322, 323
Use of	156-158
Vernier	147-160, 181-183, 321, 323
Compound Tangent Ball Spindle	162-164, 322
Constant for Stadia Wires 23
Crayon Pencils and Lumber Crayons	447
Cross Section Paper and Books	441, 442, 446
Staff Heads	474
Wires	19, 38, 304-307
Current Meter Reduction Tables	272, 273, 275-277
Meters	261-279, 338, 339
Curve Ruler	427
Curves	426-428
Declination Arc	96, 125, 174
of Magnetic Needle	152-154
of the Sun	98, 104-112
Tables	105-109
Detachable Telescopes for Transits	91, 92, 320
Diagonal Prism for Eyepiece of Telescopes	93, 320
Dial Compasses	191-194, 325

TABLE OF CONTENTS

535

	PAGE
Dip Needle Compasses	189-191, 324, 325
Disappearing Stadia Wires 23
Diurnal Variation	154
Drainage Levels	218-221, 326
Drawing Boards and Tables	417-419
Ink	454, 455
Instruments, Alteneder	355-361
Instruments and Accessories	353-462
Paper	431-435
Dust Guard for Objective Slide of Telescope	24, 197, 309, 320
Electric Current Meters	261-279, 338, 339
Register	262, 338
Electricity	157
Ellipses	427
Engineers Levels	195-212, 326
Transits	35, 44-47, 101, 313-315
Erasing Knives and Erasing Rubbers	449-452
Shields	449
Explorers Transits	48-51, 314, 315
Extras for Compasses	168, 182, 185, 322, 324
for Levels	199
for Transits	45, 47, 53, 67, 79-127, 319-321
Eye-piece for Transit Telescopes	17, 18, 306, 307
Field Bags	329
Books	445, 446
Glasses and Telescopes for Tourists	488-494
Figuring of Horizontal Limbs	28-31
Finish of Instruments	299
Fixed Stadia Wires 23
Flagstuffs or Ranging Poles	241, 242, 332, 333
Foreign Shipments	301, 302
Forest Service Compass	186, 187, 324
Geologists Compass	186, 187, 324
Grades, Attachment for establishing	89, 90
Gradiometer	89, 90, 320
Graduations of Limb and Vertical Circle	27-31, 33, 304, 308, 321
Grumman Patent Steel Chains	288, 289, 341, 342
Hand Levels	282-285, 340
Hook Gage, Boyden	280-282, 339
Horizons, Artificial	473
Hour Circle and Hour Arc	96, 127, 174, 193, 325
Hydrometers	507
Hygrometers	503
Index (Table of Contents)	533-540
India Ink	455
Information to Purchasers	295-309

	PAGE
Inks for Drawing or Writing	454, 455
Ink Slabs and Color Saucers	460, 461
Instructions for Using Transits 37
Inverting Eyepiece 18
Johnson Plane Table Movement	249, 251, 335, 336
Jointed Ranging Poles	242, 332
Jones Latitude Arc	122, 123, 321
Lacquering	299
Latitude Arc	96, 122, 123, 172, 321
Level	121, 321
Leather Cases and Pouches	51, 54, 229, 328, 329
Level Attachments for Transits	84, 85
Striding	126, 127, 321
on Telescope	84, 85, 320, 322
Vials and Spirit Levels 27, 38, 147, 155, 159, 203, 207, 208, 306, 307, 320, 499, 500	162, 164, 185, 322, 324
Leveling Adopter	33, 34, 162, 164, 204, 309, 320, 322, 324
Head	212-217, 326
Instruments, Architects	212-221, 326
Instruments, Drainage	195, 212, 326
Instruments, Engineers Y.	241, 242
Poles	230-242, 329-333
Rods and Poles 34
Screws	205-210
Levels, Adjustment of	199
Attachments for	210, 211, 215-221
Use of	212
Weights and Sizes	16, 52-55, 315
Light Mountain Transits	134, 141
Limbs of Compasses	27-31, 47, 57-61, 308, 321
of Transits	38-40, 170, 206, 207
Line of Collimation	496
Linen Prover 284, 340
Locke Hand Level	
Magnetic Declination	152-154
Needle	25, 26, 99, 139, 145, 152-155, 158
Magnets	501
Magnifiers	86, 320, 495-498
Magnifying Power of Telescope 18, 19
Marking Pins and Timber Scribe	290, 343
Metallic Tapes	292, 346
Meter Chains	289, 342, 345
Meters, Current	261-279, 338, 339
Miners Dip Needle Compasses	189-191, 324, 325
Lamps	506, 507
Mining Transits	16, 52-55, 315
Mirrors and Prisms, Reflecting	473
Monocular Hand Level	282, 283, 340
Mountain Transits	16, 52-55, 315
Mucilage	452, 453

TABLE OF CONTENTS

537

	PAGE
Needles	25, 26, 99, 139, 142, 152-155, 158
Norwegian Compass	190, 325
Objective of Telescopes	17, 306, 307
Slide of Telescopes	41, 42, 199, 200, 205, 206
Odometers	476, 477
Offset Standard	167, 322
Oilstones	500
Optical Axis	19, 166
Principle of Telescope	17, 18
Outkeeper	148, 306
Packing and Shipping	300-302
Pantographs	430
Paper Cutter	443
Drawing and Tracing	431-435, 437
Parallel Rules	429, 430
Parts of Instruments liable to injury, Prices of	302-307
Passometers	475
Payment, Terms of	297, 301, 302, 305
Pedometers	475
Pencils	446, 447
Pencil Sharpeners	449
Pens, Mapping and Writing	448
Plain Compasses	161-164, 184, 185, 322, 324
Compasses, Pocket	184, 185, 324
Plane Tables	245-255, 334-337
Planimeters	362, 363
Platinum Cross Wires	19, 38, 304-307
Stadia Wires	20-24, 304-307, 320
Plumbing Arm	246
Plummet Cord	328
Lamp	94, 320
Plummets	327, 328
Pocket Compasses	172-194, 322-325, 463-470
Leveling Rods	241, 331
Magnifiers	495-498
Rules	408-411
Solar Compass	172-177
Spirit Levels	499
Tapes	351
Transit, Brunton	467
Polar Axis	125
Poles, Jointed and Ranging	241, 242, 332, 333
Power of Telescopes	19, 168
Price List	313-329
Print Frames and Bath Trays	436, 437
Prism Field Glasses	490, 491
Prismatic Compasses	468-470
Prisms and Mirrors, Reflecting	473
Profile Paper and Books	439, 440, 444
Protractors	391-401
Punch and Riveter	352

	PAGE
Quick Leveling Attachment	320
Rack and Pinion	17, 200, 308, 320, 324
Railroad Compasses	141-146, 175-179, 321, 323
Compasses, Pocket	175-179, 323
Curves	428
Rain Gages	504, 505
Range Finder	473
Ranging Poles	241, 242, 332, 333
Reading Glasses	498
Reconnaissance Transits	68, 69, 318
Reflectors for Cross Wires and Limb of Transits	33, 92, 93, 309, 320
Refractions	104-112, 132, 133
Table of	105-111
Remittance	302
Rensselaer Polytechnic Institute	530, 531
Repairs to Instruments	158-160, 302-307
Repolishing Instruments	305
Riding or Top Telescopes	91, 92, 320
Rod Levels	243, 244, 333
Rods and Poles, Leveling	230-242, 322-333
Rubber Erasers and Accessories	449-452
Scales	400-412
Section Liners	424, 425
Selection of Instruments	295-309
Sextants	471, 472
Shifting Center for Leveling Head of Transits	34, 308
Short Focus	24, 25, 197-199, 308
Side Telescope	91, 92, 320
Sights on Standards and on Telescope of Transits	86, 320
Sizes of Compasses	142, 151, 161, 162, 173-182
of Levels	212
of Transits	45, 48-51, 61, 65, 68, 76
Sketch Blocks, Paper	437, 438
Sketching Cases, Army	256-260, 337
Slide Rules	407-411
Slope Levels	478, 479
Smith Army Sketching Case	256-258, 337
Sockets of Compasses	134, 141
of Levels	198, 204
of Transits	33, 46, 57-62, 65
Solar Attachment for Transits	46, 47, 53, 66, 67, 95-127, 321
Compasses	184-140, 172-177, 321-323
Compasses, Pocket	172-177, 322, 323
Screen	120, 321
Transits	47, 53, 66, 314, 315, 317, 318
Spads	328
Special Notice	308, 309
Spirit Levels and Level Vials	27, 38, 147, 155, 159, 203, 207, 208, 306, 307, 499, 500
Spring Balance for Chains and Tapes	350
Stadia Arc, Beaman	87, 88, 320
Hand Level	340

	PAGE
Stadia Rods	238, 239, 330
Wires, Platinum	20-24, 304-307, 320
Staff Mountings	151, 306
Stake Tacks	328
Standards	25, 40, 41
Steel Rules	411, 412
Tapes	290-293, 343-351
Stencil Alphabets and Figures	461, 462
Stop Watch or Time Recorder for Current Meters	267, 338, 339
Straight Edges	412, 413
Striding Level	126, 127, 321
Surveyors Chains	286-289, 341, 342
Cross Staff Heads	474
Transits	67-67, 316-318
Tables and Boards, Drawing	417-419
Declination	105-109
Plane	245-255, 334-337
Reduction, for Current Meters	272, 273, 275-277
Traverse (books)	526
Tacks for Drawing Boards	443
Tally Registers	476, 477
Tangent Scale on Sight Vanes	148
Tape Handles and Accessories	350
Lines, Metallic	292, 346
Lines, Steel	290-293, 347-351
Riveter for repairing tapes	352
Telegraph Codes	302
Telescope, How composed	17-24, 197, 198
Telescopes and Tourists Glasses	488-494
for Vertical Sighting, Detachable or Extra	91, 92, 320
Telescopic Sight Attachment	165-171, 322
Sight, Adjustments of	169-171
Solar Attachment	115-117, 321
Thermometers	502, 503
Timber Scribe or Marking Irons	343
Time Recorder for Current Meters	267, 338, 339
Top or Riding Telescope	91, 92
Tracing Paper and Cloth	433, 434
Trammel Points	501
Transit Instruments, General Description	17-42
Transits, Adjustment of	37-42, 53
Attachments for	45, 47, 53, 67, 79-127, 319-321
Transit, Brunton Pocket	467
Builders	72, 73, 319
Transits, Engineers	35, 44-47, 101, 313-315
Explorers	48-51, 314, 315
Light Mountain and Mining	16, 52-55, 315
Reconnaissance	68, 69, 318
Solar	47, 53, 66, 314, 315, 317, 318
Solar Attachment for	47, 53, 66, 95-127, 321
Surveyors	67-67, 316-318
Vernier	75-77, 319

	PAGE
Transits, Use of	37
Weights and Sizes of	45, 47, 61, 65, 68, 76
Transportation	301
Traverse Plane Table Board and Tripod	254, 255, 337
Tables (books)	526
Trial of Instruments	298
Triangles	420-423
Tripod Cases	329
Tripods	34, 54, 134, 223-228, 247, 327
T Squares	414-416
Tubes for Drawing Paper, Tin	437
Use of Current Meters	269-271
Compasses	156-158
Levels	210, 211, 215-221
Transits	37
Vari Chains and Tape Lines	289, 298, 342, 345
Variation Arc of Transits	27, 309, 319
of the Magnetic Needle	145, 152-155
Vellum or Tracing Cloth	433, 434
Vernier Compasses	147-160, 181-183, 321, 323
Compasses, Pocket	181-183, 323
Protractors	395-397
Transits	75-77, 319
The Use of	152
Verniers	32, 141, 147, 152
Vertical Arc and Vertical Circle	80-83, 308, 309, 319, 320
Wading Rods for Current Meters	267
Warranty	297, 298
Water Colors and Accessories	456-461
Glasses	460
Weights of Compasses	134, 142, 152, 161, 162, 177, 178, 182
Levels	212
Transits	45, 51, 54, 61, 65, 68, 76
Whatmans Drawing Paper	431
Wye Levels	195-217
Wyes	203, 204, 209, 210
Y Levels	195-217
Ys of Leveling Instruments	203, 204, 209, 210